

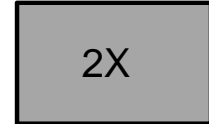

FEATURES

- Switching Transistor

SOT-23

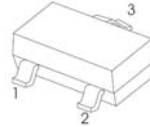

1.BASE
2.EMITTER
3.COLLECTOR

MAXIMUM RATINGS AND ELECTRICAL CHARACTERISTICS

MAXIMUM RATINGS (Ta=25°C unless otherwise noted)

Parameter	Symbol	Value	Unit
Collector–Base Voltage	V_{CBO}	60	V
Collector–Emitter Voltage	V_{CEO}	40	V
Emitter–Base Voltage	V_{EBO}	6	V
Collector Current — Continuous	I_C	600	mA
Collector Power Dissipation	P_C	300	mW
Thermal Resistance From Junction To Ambient	R_{thJA}	417	°C/W
Operation Junction and Storage Temperature Range	T_J, T_{stg}	-55~+150	°C

ELECTRICAL CHARACTERISTICS (TA = 25°C unless otherwise noted.)

Parameter	Symbol	Test conditions	Min	Typ	Max	Unit
Collector-base breakdown voltage	$V_{(BR)CBO}$	$I_C = 100\mu A, I_E = 0$	60			V
Collector-emitter breakdown voltage	$V_{(BR)CEO}$	$I_C = 1\text{ mA}, I_B = 0$	40			V
Emitter-base breakdown voltage	$V_{(BR)EBO}$	$I_E = 100\mu A, I_C = 0$	6			V
Collector cut-off current	I_{CBO}	$V_{CB} = 50V, I_E = 0$			0.1	μA
Collector cut-off current	I_{CEX}	$V_{CE} = 35V, V_{EB} = 0.4V$			0.1	μA
Emitter cut-off current	I_{EBO}	$V_{EB} = 5V, I_C = 0$			0.1	μA
DC current gain	h_{FE1}	$V_{CE} = 1V, I_C = 0.1\text{ mA}$	20			
	h_{FE2}	$V_{CE} = 1V, I_C = 1\text{ mA}$	40			
	h_{FE3}	$V_{CE} = 1V, I_C = 10\text{ mA}$	80			
	h_{FE4}	$V_{CE} = 1V, I_C = 150\text{ mA}$	100		300	
	h_{FE5}	$V_{CE} = 2V, I_C = 500\text{ mA}$	40			
Collector-emitter saturation voltage	$V_{CE(sat)}$	$I_C = 150\text{ mA}, I_B = 15\text{ mA}$			0.4	V
		$I_C = 500\text{ mA}, I_B = 50\text{ mA}$			0.75	V
Base-emitter saturation voltage	$V_{BE(sat)}$	$I_C = 150\text{ mA}, I_B = 15\text{ mA}$			0.95	V
		$I_C = 500\text{ mA}, I_B = 50\text{ mA}$			1.2	V
Transition frequency	f_T	$V_{CE} = 10V, I_C = 20\text{ mA}, f = 100\text{ MHz}$	250			MHz
Delay time	t_d	$V_{CC} = 30V, V_{BE(off)} = -2V, I_C = 150\text{ mA}, I_{B1} = 15\text{ mA}$			15	ns
Rise time	t_r				20	ns
Storage time	t_s	$V_{CC} = 30V, I_C = 150\text{ mA}, I_{B1} = I_{B2} = 15\text{ mA}$			225	ns
Fall time	t_f				60	ns

RATING AND CHARACTERISTIC CURVES

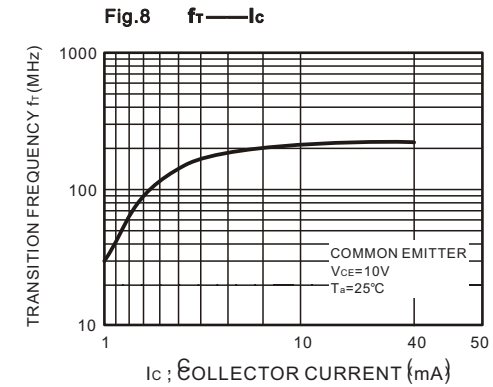
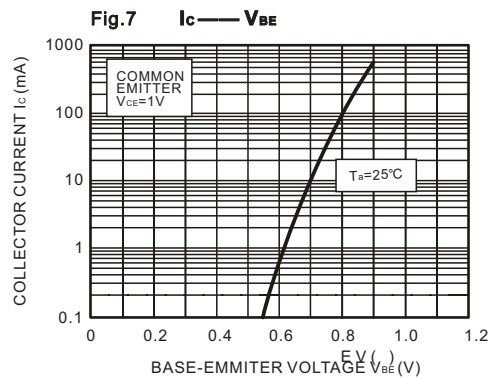
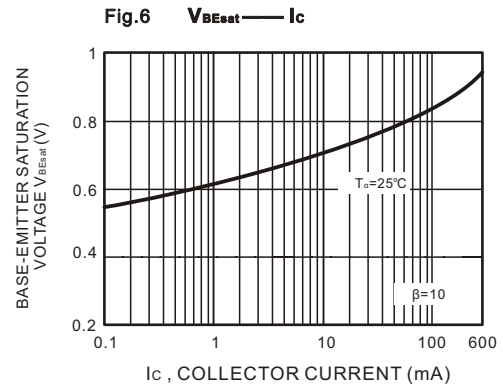
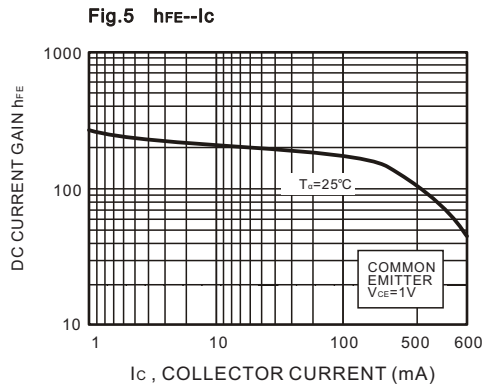
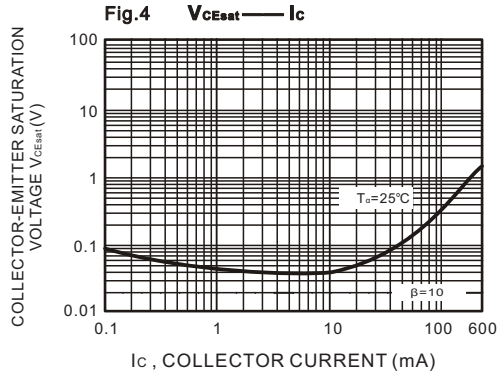
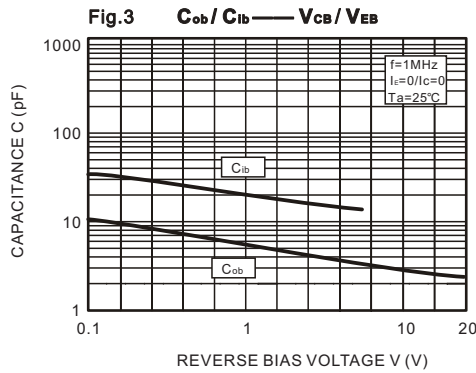
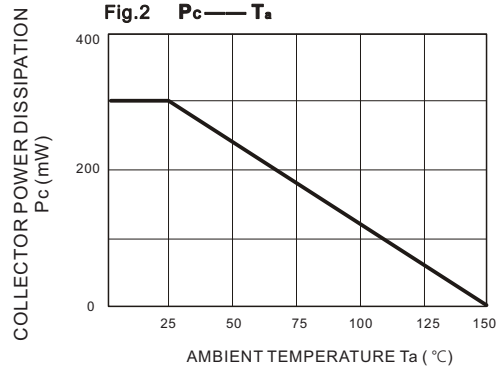
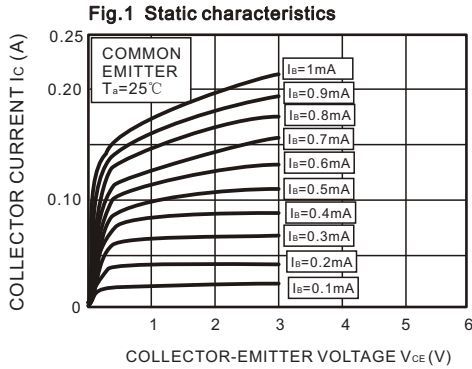

Soldering parameters

Reflow Condition		Pb-Free assembly (see as below)
Pre Heat	-Temperature Min ($T_{s(min)}$)	+150°C
	-Temperature Max ($T_{s(max)}$)	+200°C
	-Time (Min to Max) (ts)	60-180 secs.
Average ramp up rate (Liquid us Temp (T_L) to peak)		3°C/sec. Max
$T_{s(max)}$ to T_L - Ramp-up Rate		3°C/sec. Max
Reflow	-Temperature (T_L) (Liquid us)	+217°C
	-Temperature (t_L)	60-150 secs.
Peak Temp (T_P)		+260(+0/-5)°C
Time within 5°C of actual Peak Temp (t_p)		30 secs. Max
Ramp-down Rate		6°C/sec. Max
Time 25°C to Peak Temp (T_P)		8 min. Max
Do not exceed		+260°C

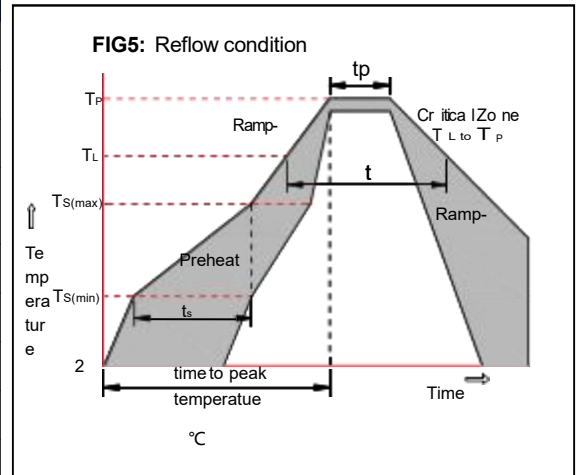

Package Dimensions & Suggested Pad Layout

SOT23

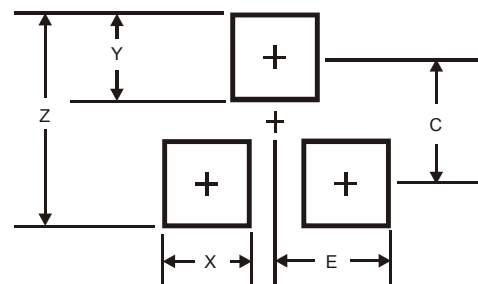
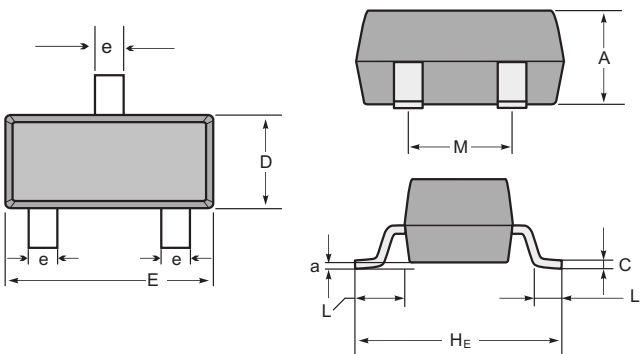

SOT-23 mechanical data

UNIT	A	C	D	E	H_e	e	M	L	L_1	a	
mm	max	1.1	0.15	1.4	3.0	2.6	0.5	1.95	0.55 (ref)	0.36 (ref)	0.0
	min	0.9	0.08	1.2	2.8	2.2	0.3	1.7			0.15
mil	max	43	6	55	118	102	20	77	22 (ref)	14 (ref)	0.0
	min	35	3	47	110	87	12	67			6

Dimensions	SOT23
Z	2.9
X	0.8
Y	0.9
C	2.0
E	1.35

Tape & reel specification

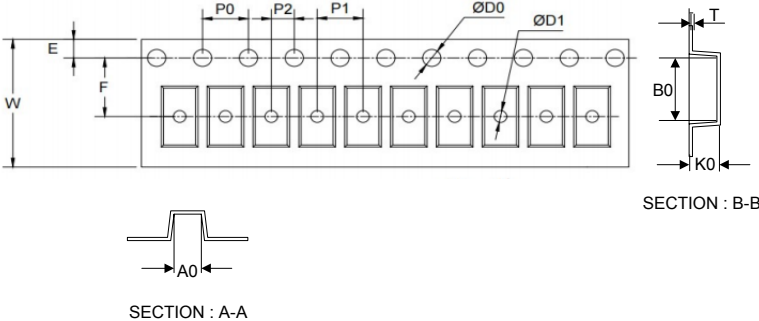
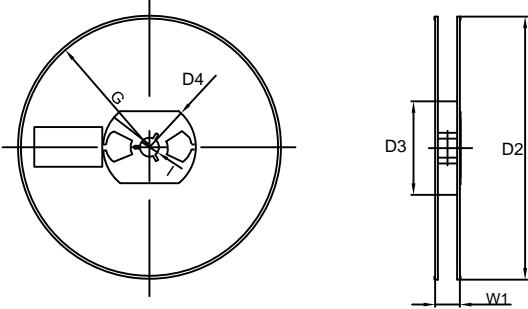
Tape	Symbol	Dimension (mm)	
	P0	4.00±0.10	
	P1	4.00±0.10	
	P2	2.00±0.10	
	D0	1.55±0.10	
	D1	1.05±0.10	
	E	1.55±0.10	
	F	3.60±0.10	
	W	8.00±0.10	
	A0	3.80±0.20	
	B0	3.25±0.20	
	K0	1.45±0.10	
	T	0.25±0.05	
	<p>7" Reel</p> 	D2	178.0±3.0
		D3	55Min.
D4		R24.0±3.0	
G		R82.0±3.0	
I		13.0±2.0	
W1		11.0±3.0	
Quantity: 3000PCS			