

芯伯乐®
X I N B O L E

Product Specification

XBL29300

3A Fast Response LDO Regulator

WEB | www.xinboleic.com



Descriptions

The XBL29300 is a high-current. The 3A LDO regulator features 300mV to 370mV (full load) dropout voltage and very low ground current. Designed for high-current loads, these devices also find applications in lower current, low-dropout critical systems, where their dropout voltages and ground current values are important attributes.

Along with a total accuracy of $\pm 2\%$ (over temperature, line, and load regulation) the regulator features very fast transient recovery from input voltage surges and output load current changes.

The XBL29300 has a Fixed output that have voltage of 3.3V, 5.0V, 12V.

In addition, the device is fully protected against overcurrent faults, reversed input polarity, reversed lead insertion, and over temperature operation.

The XBL29300 is available in the standard TO263-3L and TO220-3 package with an operating junction temperature range of -40°C to $+125^{\circ}\text{C}$.

Features

- High-Current Capability
- Operating Input Voltage Range: 3V to 26V
- Low Dropout Voltage
- Low Ground Current
- Accurate 1% Tolerance
- Fast Transient Response
- Fixed Output Voltage: 3.3V, 5V, 12V
- Packages: TO-263-3L and TO220-3 package



TO-263-3L

TO-220

Ordering Information

Product Model	Package Type	Marking	Packing	Packing Qty
XBL29300T-3.3	TO-220-3	XBL29300T-3.3	Tube	1000Pcs/Box
XBL29300T-5.0	TO-220-3	XBL29300T-5.0	Tube	1000Pcs/Box
XBL29300T-12	TO-220-3	XBL29300T-12	Tube	1000Pcs/Box
XBL29300S-3.3DTR	TO-263-3	XBL29300S-3.3	Tape	800Pcs/Reel
XBL29300S-5.0DTR	TO-263-3	XBL29300S-5.0	Tape	800Pcs/Reel
XBL29300S-12DTR	TO-263-3	XBL29300S-12	Tape	800Pcs/Reel

Pin Description

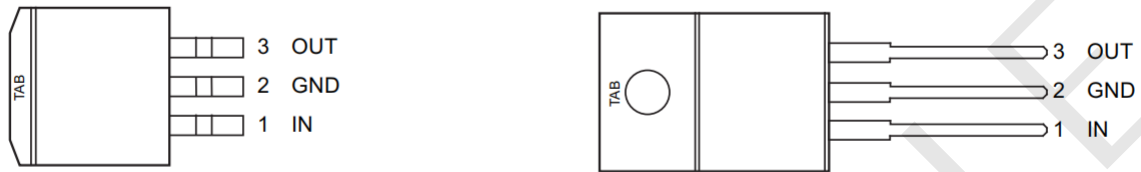

Typical Application Circuit

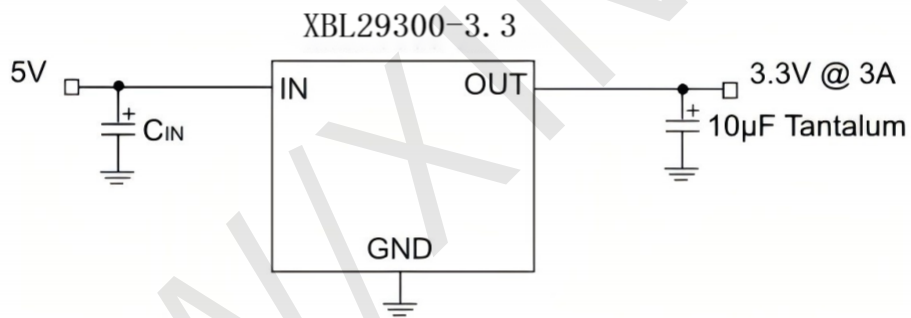

Functional Block Diagram

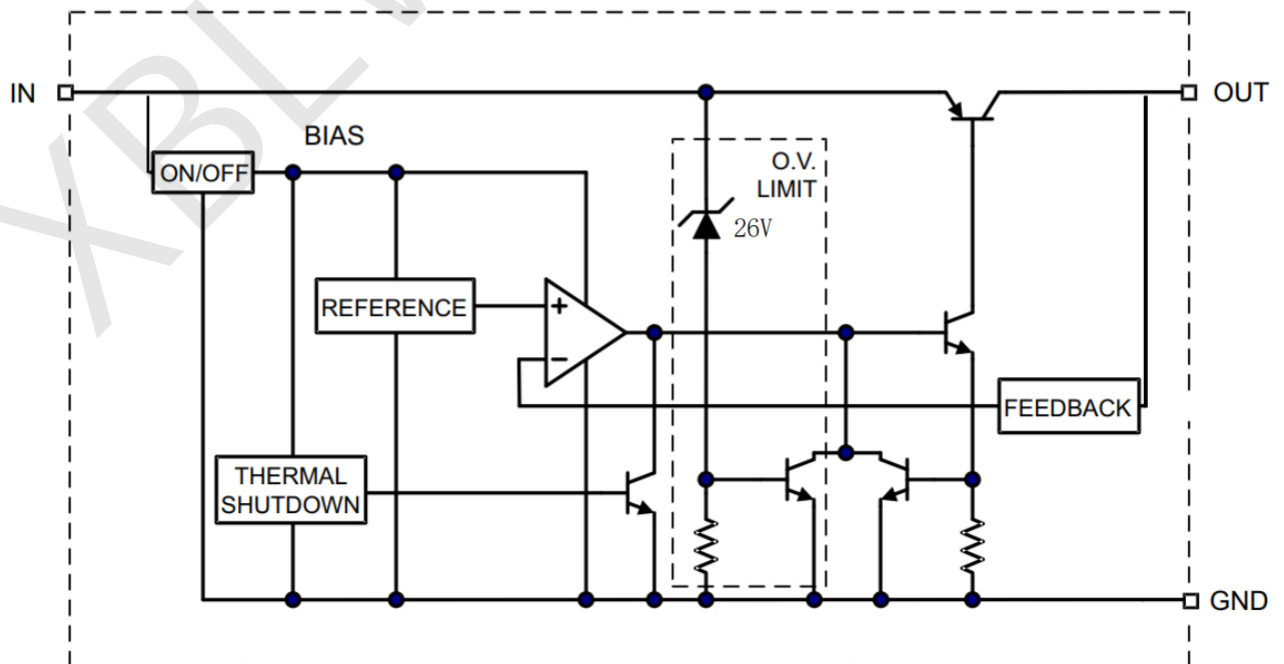

Absolute Maximum Ratings (Ta=25 ° C)

Rating	Symbol	Value	Unit
Input Supply Voltage	V _{IN}	30	V
Enable Input Voltage	V _{EN}	V _{IN}	V
Operating Junction Temperature Range	T _J	-40 to +125	°C
Storage Temperature Range	T _{stg}	-65 to +150	°C
Operating Input Voltage	V _{OP}	3~26	V
Package Thermal Resistances TO263-3L/TO220-3L	θ _{JC}	3	°C/W
Package Thermal Resistances TO263-3L/TO220-3L	θ _{JA}	28	°C/W

† **Notice:** Stresses above those listed under "Absolute Maximum Ratings" may cause permanent damage to the device. This is a stress rating only and functional operation of the device at those or any other conditions above those indicated in the operational sections of this specification is not intended. Exposure to maximum rating conditions for extended periods may affect device reliability.

‡ **Notice:** The device is not guaranteed to function outside its operating ratings.

Note 1: Maximum positive supply voltage of 60V must be of limited duration (<100 ms) and duty cycle (≤1%). The maximum continuous supply voltage is 26V. Exceeding the absolute maximum rating may damage the device.

2: Devices are ESD sensitive. Handling precautions recommended.

Electrical Characteristics

V_{IN} = 4.184V; I_{OUT} = 100 mA; T_A = +25°C, bold values indicate -40°C ≤ T_J ≤ +125°C, unless noted. Note1

Parameter	Symbol	Min.	Typ.	Max.	Units	Conditions
Output Voltage						
Output Voltage Accuracy	ΔV _{OUT}	-2	—	2	%	100 mA ≤ I _{OUT} ≤ 3A, (V _{OUT} + 1V) ≤ V _{IN} ≤ 26V
Line Regulation	ΔV _{OUT} / ΔV _{IN}	—	0.1	0.5	%	I _{OUT} = 100 mA, (V _{OUT} + 1V) ≤ V _{IN} ≤ 26V
Load Regulation	ΔV _{OUT} / ΔI _{OUT}	—	0.2	1	%	V _{IN} = V _{OUT} + 1V, 100 mA ≤ I _{OUT} ≤ 3A
Dropout Voltage (Note 2)	V _{DO}	—	100	200	mV	I _{OUT} = 100 mA, V _{IN} ≥ 3.184V
		—	300	—		I _{OUT} = 1.5A, V _{IN} ≥ 3.184V
		—	500	—		I _{OUT} = 2.75A, V _{IN} ≥ 3.184V
		—	560	800		I _{OUT} = 3A, V _{IN} ≥ 3.4V

Typical Characteristics

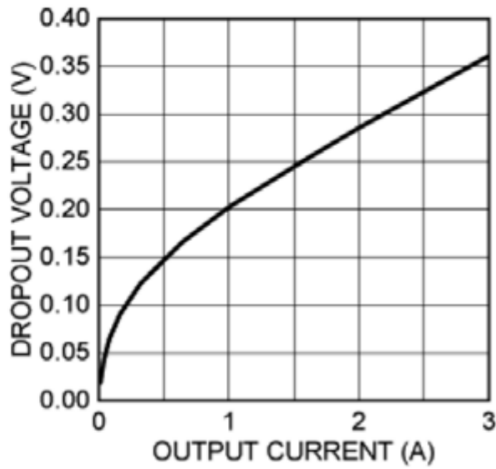

Dropout Voltage vs. Output Current

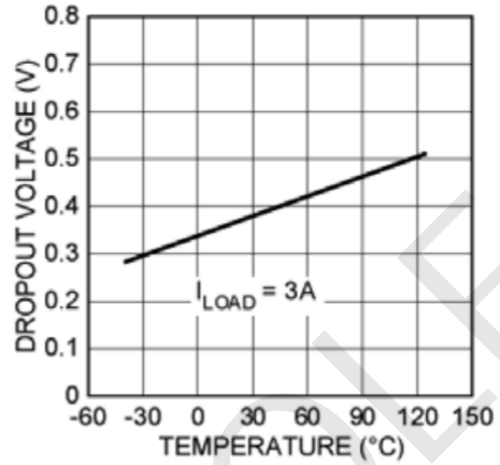

Dropout Voltage vs. Temperature.

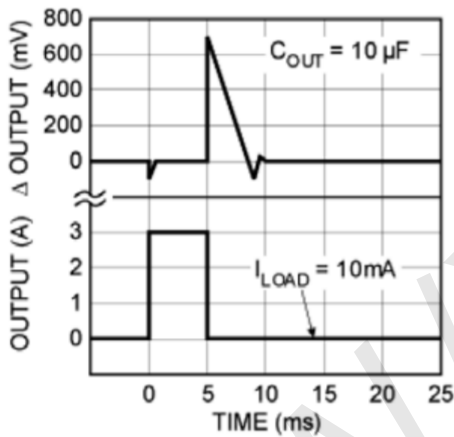

Load Transient.

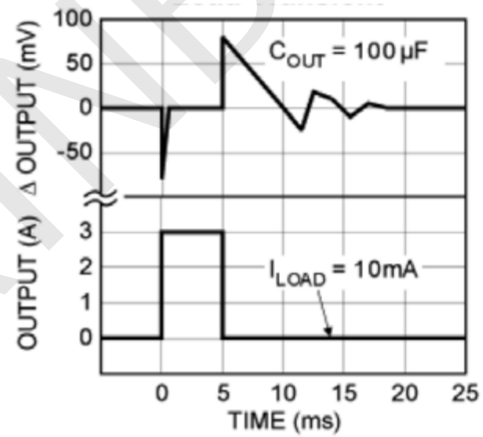

Load Transient.

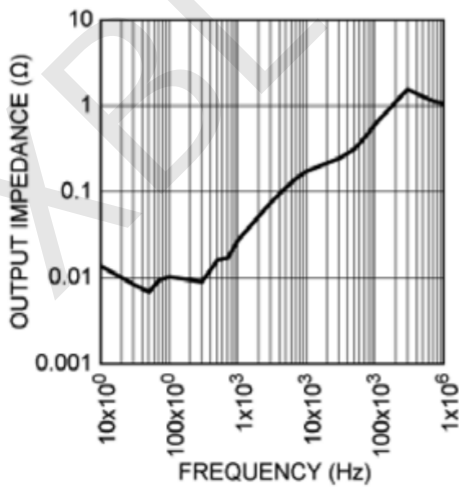

Output Impedance vs. Frequency

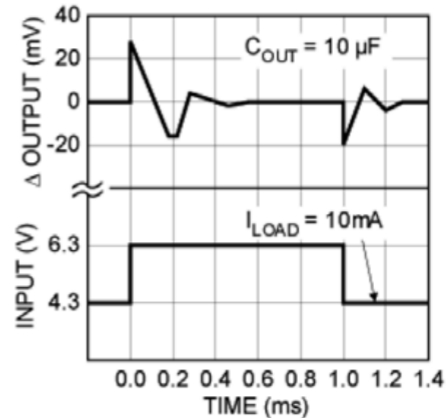

Line Transient.

Typical Characteristics

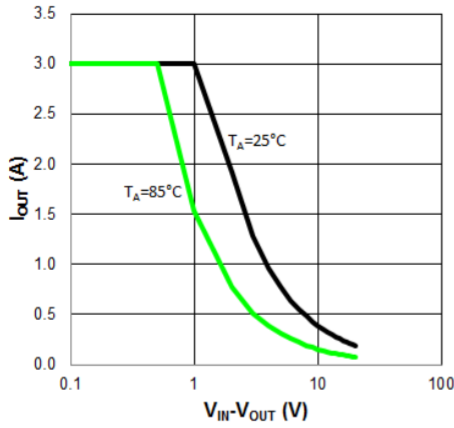

I_{OUT} vs. $V_{IN} - V_{OUT}$ SOA(TO-263/TO220-3).

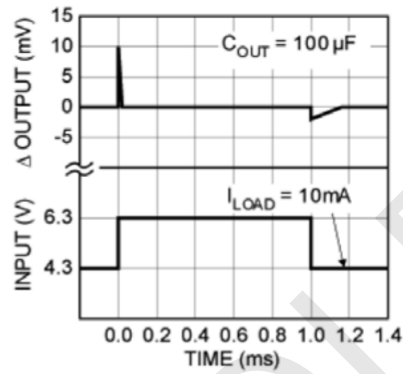

Line Transient.

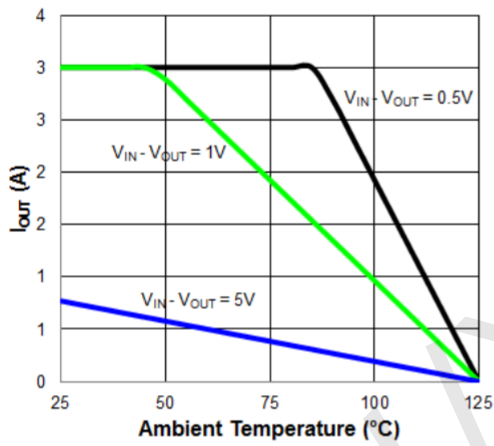

I_{OUT} vs. T_A SOA(TO-263/TO220-3).

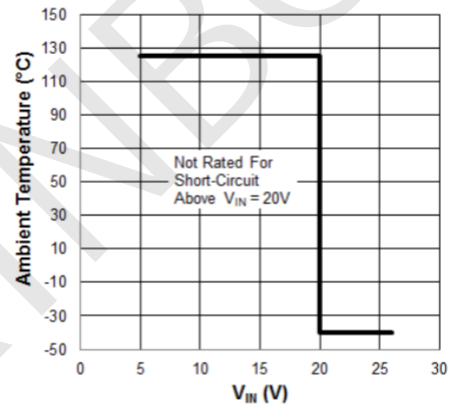

Short-Circuit SOA vs. Temperature (TO-263/TO220-3)

APPLICATION INFORMATION

The XBL29300 is a high-performance, low-dropout voltage regulator suitable for all moderate to high-current voltage regulation applications. Its 560 mV typical dropout voltage at full load makes it especially valuable in battery-powered systems and as high efficiency noise filters in post-regulator applications. Unlike older NPN-pass transistor designs, where the minimum dropout voltage is limited by the base-emitter voltage drop and collector-emitter saturation voltage, dropout performance of the PNP output is limited merely by the low VCE saturation voltage.

A trade-off for the low dropout voltage is a varying base driver requirement. But the Super β PNP process reduces this drive requirement to merely 1% of the load current.

The XBL29300 regulator is fully protected from damage due to fault conditions. Current limiting is linear; output current under overload conditions is constant. Thermal shutdown disables the device when the die temperature exceeds the +125°C maximum safe operating temperature. The output structure of the regulators allows voltages in excess of the desired output voltage to be applied without reverse current flow.

1. Capacitor Requirements

For stability and minimum output noise, a capacitor on the regulator output is necessary. The value of this capacitor is dependent upon the output current; lower currents allow smaller capacitors. The XBL29300 is stable with a 10 μ F capacitor at full load.

This capacitor need not be an expensive low-ESR type; aluminum electrolytics are adequate. In fact, extremely low-ESR capacitors may contribute to instability. Tantalum capacitors are recommended for systems where fast load transient response is important.

When the regulator is powered from a source with high AC impedance, a 0.1 μ F capacitor connected between input and GND is recommended.

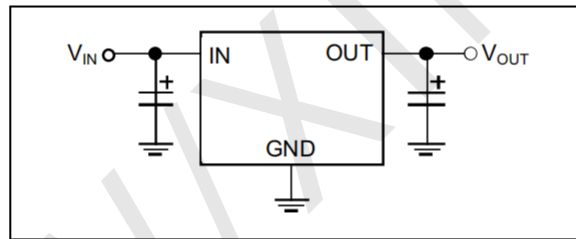

FIGURE 1: Linear Regulators Require Only Two Capacitors for Operation.

2. Transient Response and 5V to 3.3V Conversion.

The XBL29300 has excellent response to variations in input voltage and load current. By virtue of its low dropout voltage, the device does not saturate into dropout as readily as similar NPN-based designs. A 3.3V output XBL LDO will maintain full speed and performance with an input supply as low as 4.2V, and will still provide some regulation with supplies down to 3.8V, unlike NPN devices that require 5.1V or more for good performance and become nothing more than a resistor under 4.6V of input. XBL's PNP regulators provide superior performance in "5V to 3.3V" conversion applications than NPN regulators, especially when all tolerances are considered.

3. Minimum Load Current

The XBL29300 regulator operates within a specified load range. If the output current is too small, leakage currents dominate and the output voltage rises.

A minimum load current of 10 mA is necessary for proper regulation and to swamp any expected leakage current across the operating temperature range.

Package Information

· T0-220

Symbol	Dimensions In Millimeters		Symbol	Dimensions In Inches	
	Min (mm)	Max (mm)		Min (in)	Max (in)
A	4.470	4.670	A	0.176	0.184
A1	2.520	2.820	A1	0.099	0.111
b	0.710	0.910	b	0.028	0.036
b1	1.170	1.370	b1	0.046	0.054
c	0.310	0.530	c	0.012	0.021
c1	1.170	1.370	c1	0.046	0.054
D	10.01	10.31	D	0.394	0.406
E	8.500	8.900	E	0.335	0.350
E1	12.06	12.46	E1	0.475	0.491
e	2.540 (TYP)		e	0.100 (TYP)	
e1	4.980	5.180	e1	0.196	0.204
F	2.590	2.890	F	0.102	0.114
L	13.40	13.80	L	0.528	0.543
L1	3.560	3.960	L1	0.140	0.156
Φ	3.735	3.935	Φ	0.147	0.155

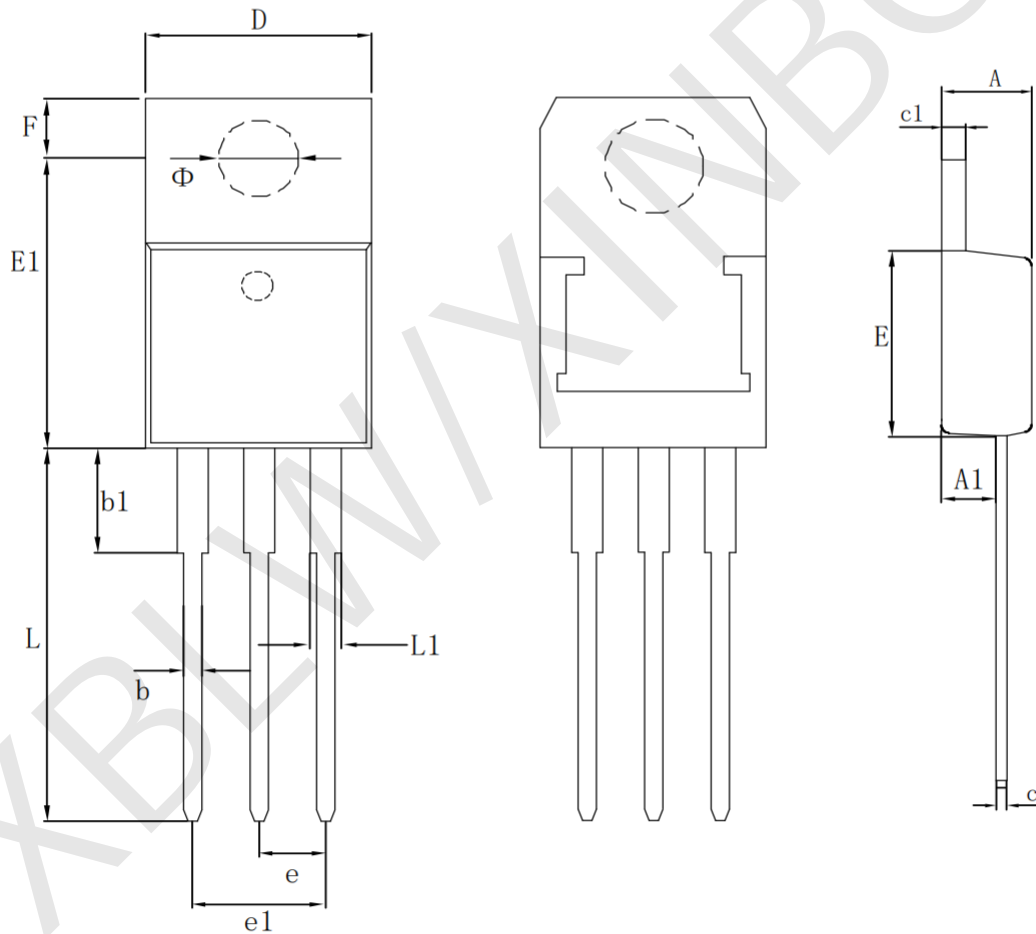

· T0-263-3L

Symbol	Dimensions In Millimeters		Symbol	Dimensions In Inches	
	Min (mm)	Max (mm)		Min (in)	Max (in)
A	4.470	4.670	A	0.176	0.184
A1	0.000	0.150	A1	0.000	0.006
B	1.120	1.420	B	0.044	0.056
b	0.710	0.910	b	0.028	0.036
b1	1.170	1.370	b1	0.046	0.054
c	0.310	0.530	c	0.012	0.021
c1	1.170	1.370	c1	0.046	0.054
D	10.01	10.31	D	0.394	0.406
E	8.700	9.400	E	0.343	0.370
e	2.540 (TYP)		e	0.100 (TYP)	
e1	4.980	5.180	e1	0.196	0.204
L	14.94	15.50	L	0.588	0.610
L1	4.950	5.450	L1	0.195	0.215
L2	2.340	2.740	L2	0.092	0.860
V	5.600 (REF)		V	0.220 (REF)	
Φ	0°	8°	Φ	0°	8°

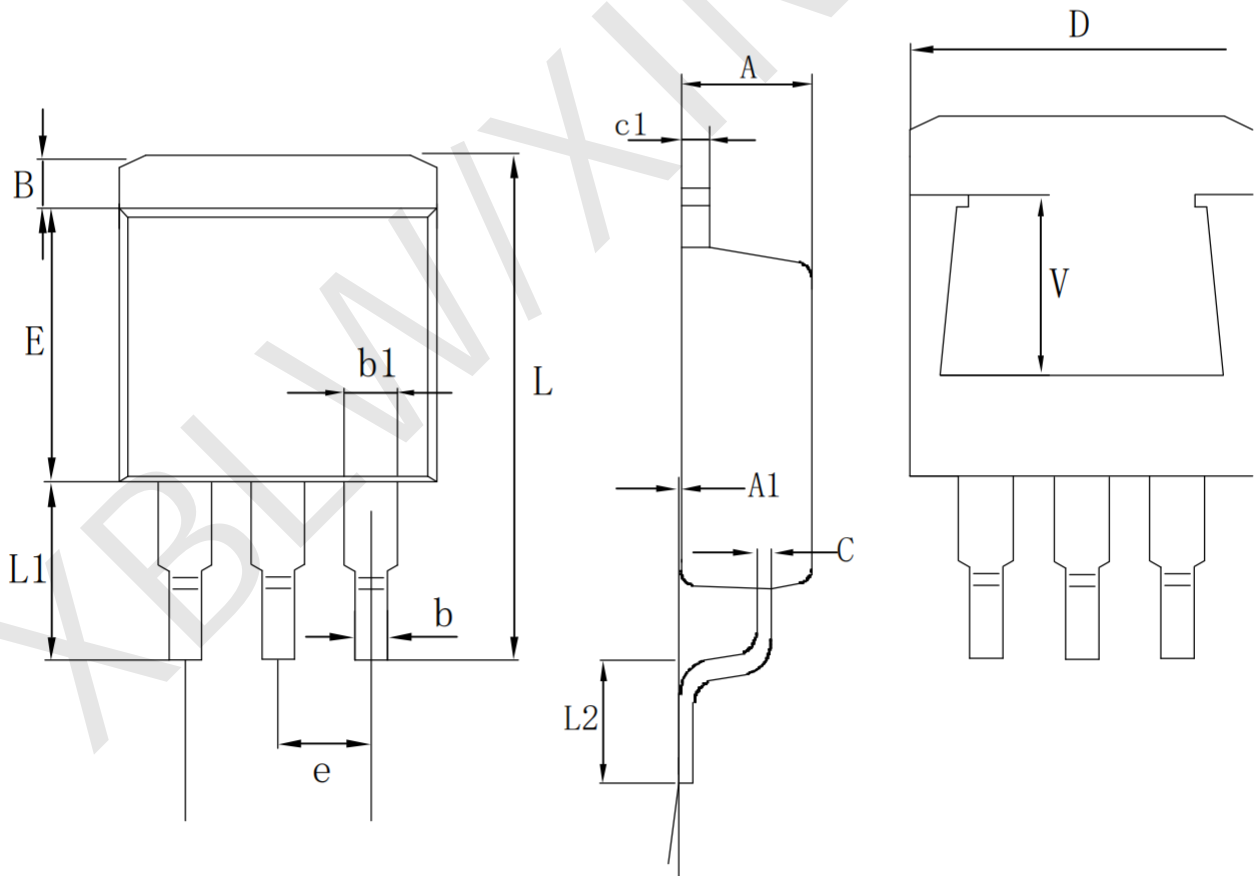

Statement:

- XBLW reserves the right to modify the product manual without prior notice! Before placing an order, customers need to confirm whether the obtained information is the latest version and verify the completeness of the relevant information.
- Any semiconductor product may malfunction under specified conditions. When using XBLW products for system design and overall manufacturing, the buyer is responsible for complying with safety standards and taking appropriate safety measures to avoid risks that may cause personal injury or property damage.
- XBLW products have not been licensed for life support, military, and aerospace applications, and therefore XBLW is not responsible for any consequences arising from the use of this product in these areas.
- If any or all XBLW products (including technical data, services) described or contained in this document are subject to any applicable local export control laws and regulations, they may not be exported without an export license from the relevant authorities in accordance with such laws.
- The specifications of any and all XBLW products described or contained in this document specify the performance, characteristics, and functionality of said products in their standalone state, but do not guarantee the performance, characteristics, and functionality of said products installed in Customer's products or equipment. In order to verify symptoms and conditions that cannot be evaluated in a standalone device, the Customer should ultimately evaluate and test the device installed in the Customer's product device.
- XBLW documentation is only allowed to be copied without any alteration of the content and with the relevant authorization. XBLW assumes no responsibility or liability for altered documents.
- XBLW is committed to becoming the preferred semiconductor brand for customers, and XBLW will strive to provide customers with better performance and better quality products.