

## MCMB-1040 Series

### High Current Molded Power Inductors

#### FEATURES

- Powder iron core material
- Magnetically shielded, low EMI
- High current carrying capacity, Low core losses
- Frequency range up to 3 MHz
- Operate temperature range ....  $-40^{\circ}\text{C} \sim +125^{\circ}\text{C}$  (Including self temp. rise)
- RoHS compliant

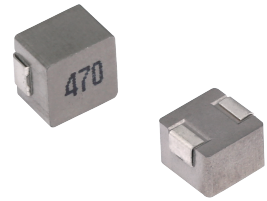

#### APPLICATIONS

- Voltage Regulator Module (VRM)
- Multi-phase regulators
- Point-of-load modules
- Smart phone POL modules
- SSD modules
- Notebook regulators
- Battery power systems
- Graphics cards
- Data networking and storage systems

#### Explanation of Part Number

MCMB -1040 -1R0 M T

1 2 3 4 5

- ◆ 1:Product Series: Metal Alloy Molding Power Inductor
- ◆ 2:Dimensions:
- ◆ 3: Initial inductance value: 1R0 = 1.0uH
- ◆ 4:Tolerance of Inductance:M:±20%
- ◆ 5:Packing:Tape Carrier Package

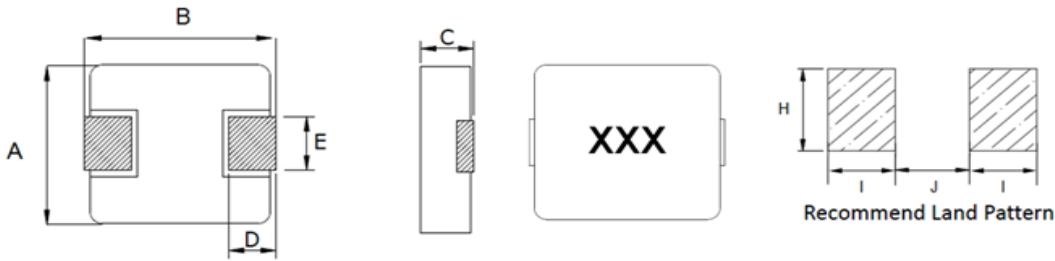
**Dimensions: [mm]**

| Series    | A        | B       | C       | D       | E       | I Typ. | J Typ. | H Typ. |
|-----------|----------|---------|---------|---------|---------|--------|--------|--------|
| MCMB-1040 | 10.0±0.3 | 11.5Max | 3.8±0.2 | 2.0±0.5 | 3.0±0.5 | 4.1    | 5.4    | 4.1    |

**Electrical Properties:**

| Part Number     | Inductance | DC Resistance | Saturation Current |      | Heat Rating Current |      |
|-----------------|------------|---------------|--------------------|------|---------------------|------|
|                 | @100KHZ,1V | Max.          | Max.               | Typ. | Max.                | Typ. |
| Units           | μH         | mΩ            | A                  |      | A                   |      |
| Symbol          | L          | DCR           | Isat               |      | Irms                |      |
| MCMB-1040-R13MT | 0.13±20%   | 0.52 (±5%)    | 63.0               | 92.0 | 63.0                | 72.0 |
| MCMB-1040-R15MT | 0.15±20%   | 0.65          | 60.0               | 75.0 | 40.0                | 45.0 |
| MCMB-1040-R22MT | 0.22±20%   | 1             | 48.0               | 60.0 | 30.0                | 35.0 |
| MCMB-1040-R30MT | 0.30±20%   | 1.1           | 36.0               | 45.0 | 30.0                | 35.0 |
| MCMB-1040-R36MT | 0.36±20%   | 1.2           | 36.0               | 45.0 | 25.0                | 30.0 |
| MCMB-1040-R45MT | 0.45±20%   | 1.5           | 34.0               | 43.0 | 25.0                | 30.0 |
| MCMB-1040-R47MT | 0.47±20%   | 1.7           | 32.0               | 40.0 | 25.0                | 30.0 |
| MCMB-1040-R56MT | 0.56±20%   | 1.8           | 26.4               | 33.0 | 20.0                | 25.0 |
| MCMB-1040-R68MT | 0.68±20%   | 2.4           | 24.0               | 30.0 | 19.0                | 23.0 |
| MCMB-1040-R80MT | 0.80±20%   | 2.7           | 23.2               | 29.0 | 19.0                | 23.0 |
| MCMB-1040-1R0MT | 1.0±20%    | 3.3           | 22.4               | 28.0 | 16.0                | 19.0 |
| MCMB-1040-1R5MT | 1.5±20%    | 4.2           | 19.2               | 24.0 | 14.0                | 16.0 |
| MCMB-1040-2R2MT | 2.2±20%    | 7             | 13.2               | 16.5 | 10.0                | 12.0 |
| MCMB-1040-3R3MT | 3.3±20%    | 11.8          | 12.8               | 16.0 | 9.50                | 11.0 |
| MCMB-1040-4R7MT | 4.7±20%    | 20            | 10.4               | 13.0 | 7.50                | 9.00 |
| MCMB-1040-6R8MT | 6.8±20%    | 25            | 9.60               | 12.0 | 7.00                | 8.50 |
| MCMB-1040-8R2MT | 8.2±20%    | 27            | 7.20               | 9.00 | 6.80                | 8.00 |
| MCMB-1040-100MT | 10±20%     | 30            | 6.80               | 8.50 | 6.90                | 7.80 |
| MCMB-1040-150MT | 15±20%     | 45            | 5.60               | 7.00 | 5.60                | 6.50 |
| MCMB-1040-220MT | 22±20%     | 66            | 4.40               | 5.50 | 4.20                | 5.00 |
| MCMB-1040-330MT | 33±20%     | 92            | 3.84               | 4.80 | 3.80                | 4.40 |
| MCMB-1040-470MT | 47±20%     | 145           | 3.10               | 3.50 | 2.80                | 3.30 |
| MCMB-1040-680MT | 68±20%     | 195           | 2.40               | 3.00 | 2.00                | 2.50 |
| MCMB-1040-820MT | 82±20%     | 285           | 2.30               | 2.80 | 2.10                | 2.30 |
| MCMB-1040-101MT | 100±20%    | 340           | 2.10               | 2.30 | 1.80                | 2.00 |

### Notes

- ※1: All test data is referenced to 20°C ambient;
- ※2: Rated current: Isat or Irms, whichever is smaller;
- ※3: Isat(Typ): DC current at which the inductance drops approximate 30% from its value without current;
- ※4: Isat(Max): DC current at which the inductance drops approximate 20% from its value without current;
- ※5: Irms(Typ): DC current that causes the temperature rise ( $\Delta T = 40^\circ\text{C}$ ) from 20°C ambient.
- ※6: Irms(Max): DC current that causes the temperature rise ( $\Delta T = 20^\circ\text{C}$ ) from 20°C ambient.
- ※7: Absolute maximum voltage 30VDC

### Typical Performance Curve:

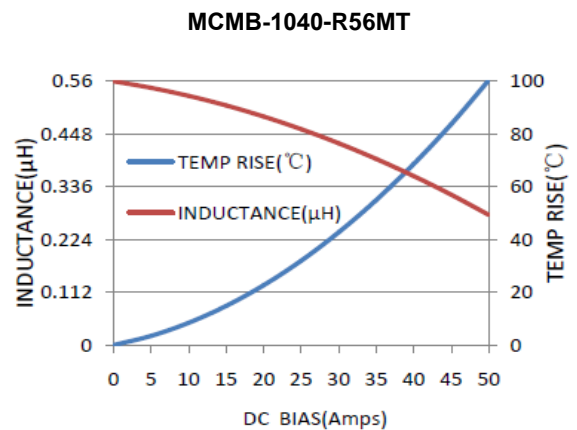
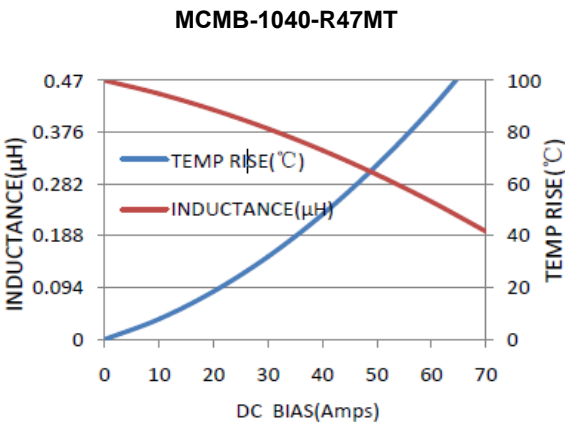
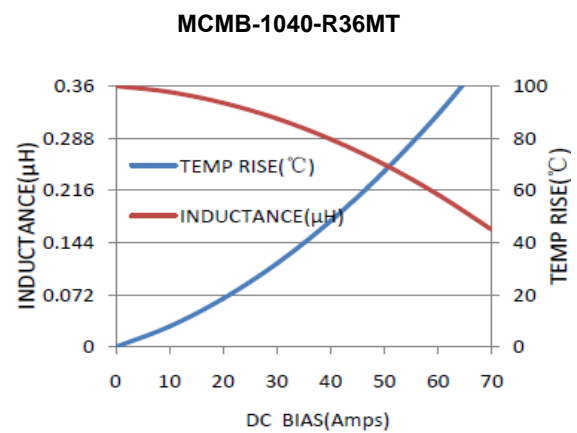
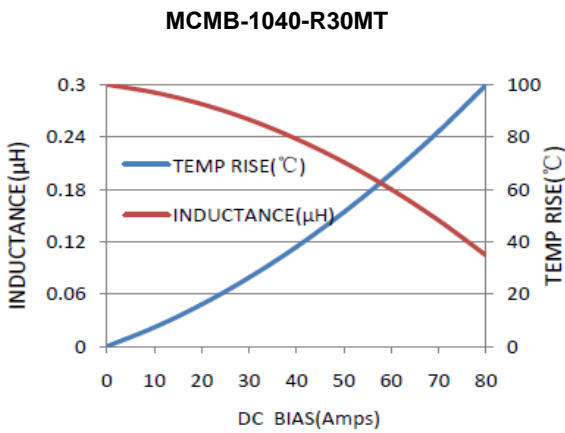
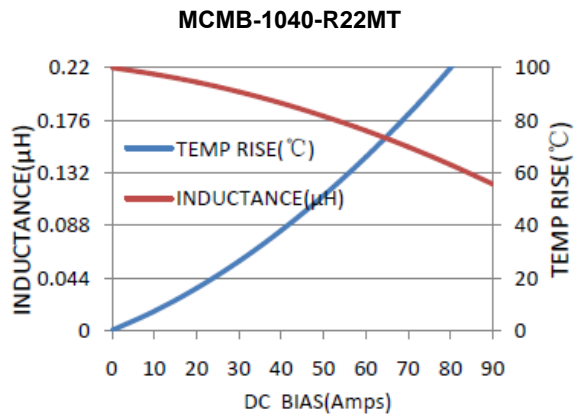
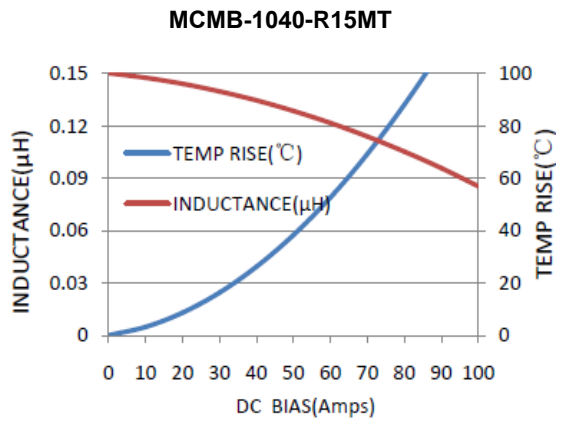

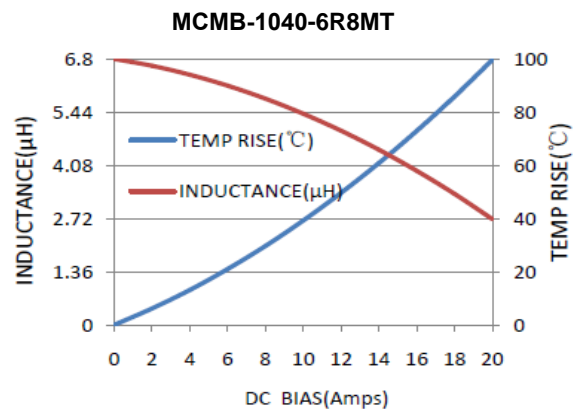
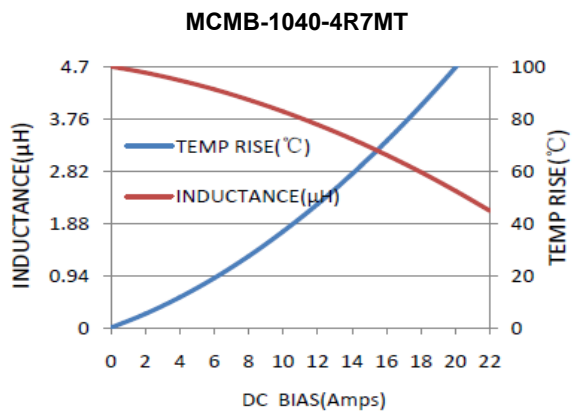
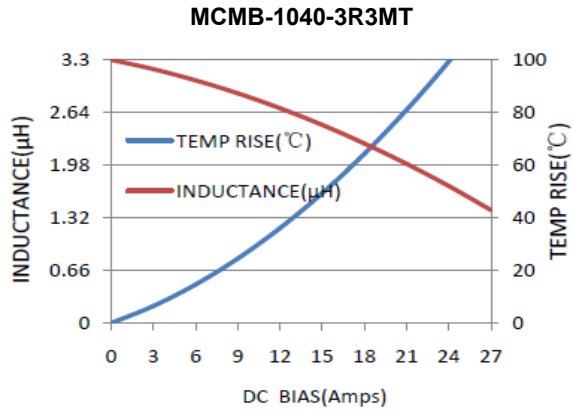
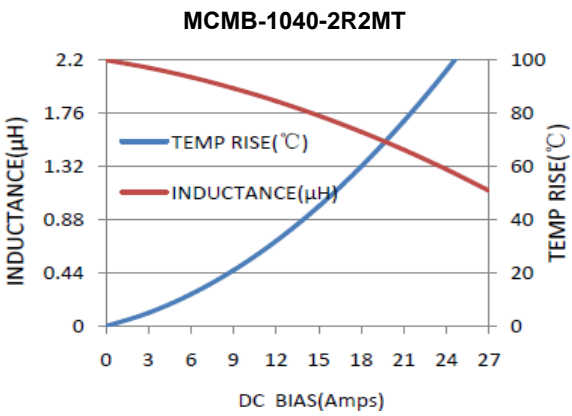
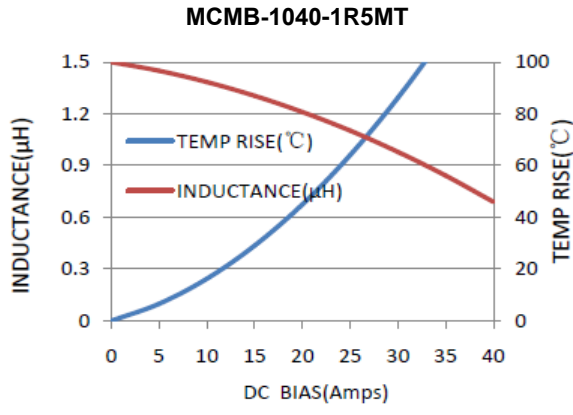
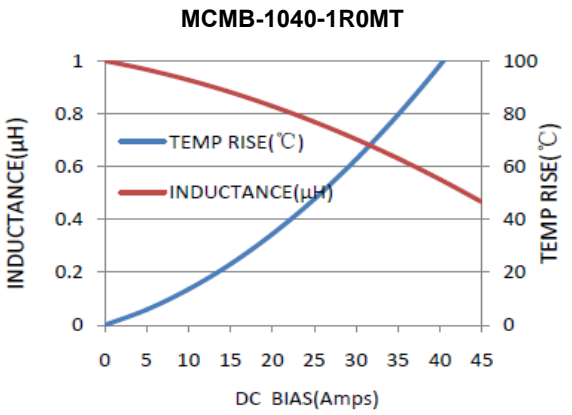
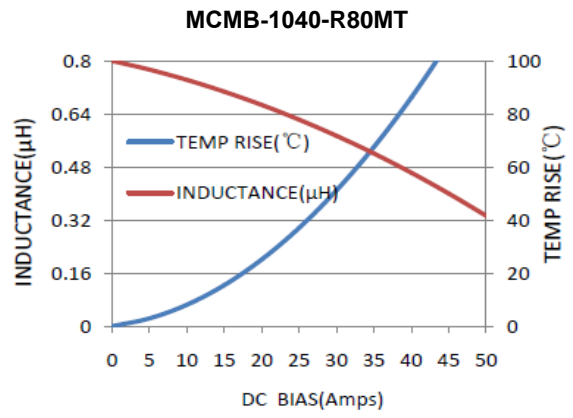
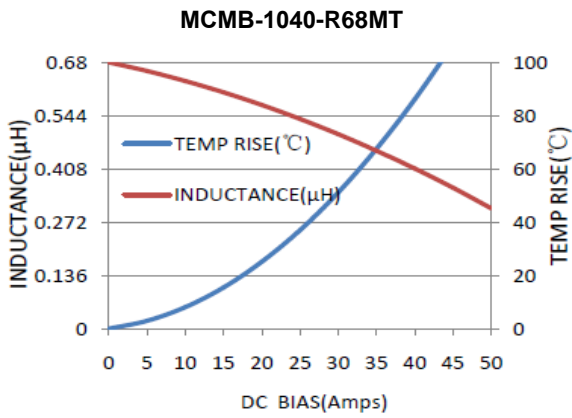

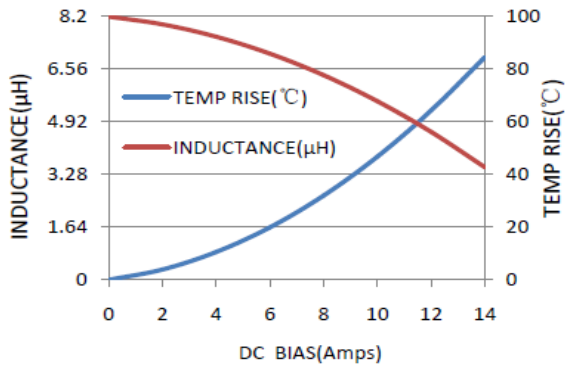
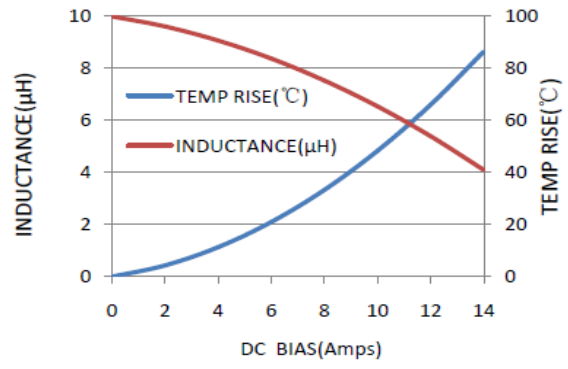
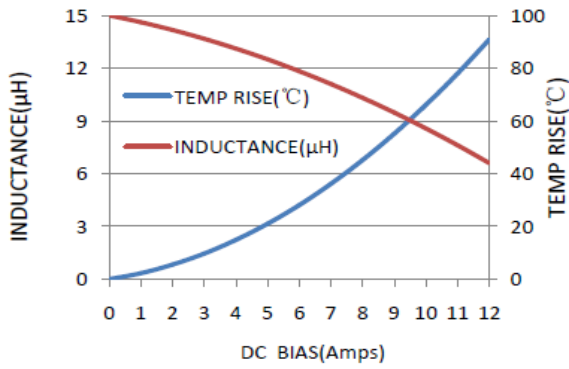
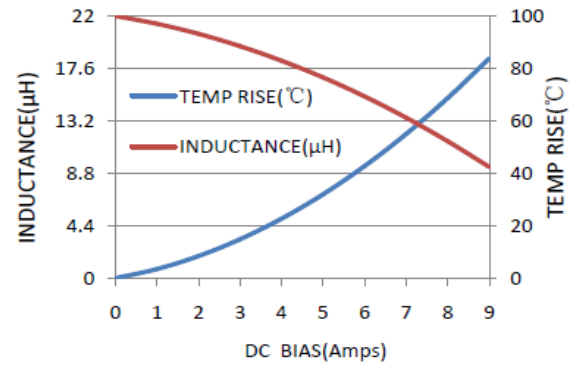
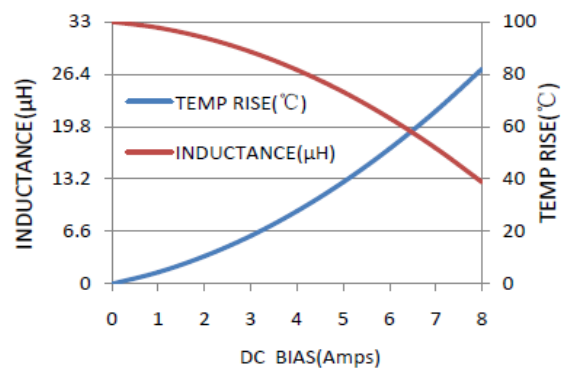
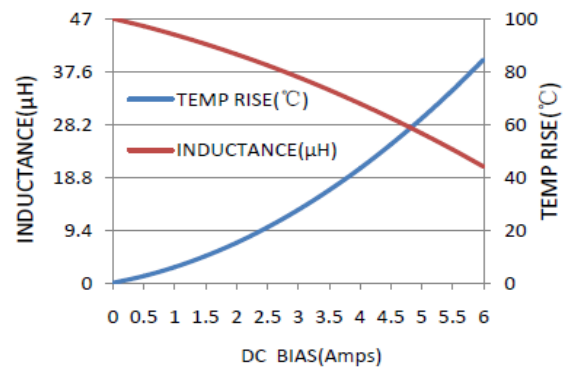
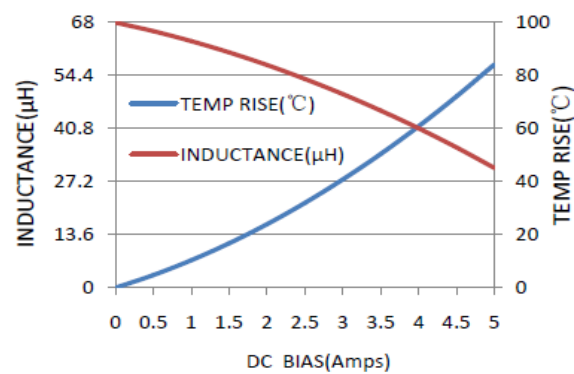
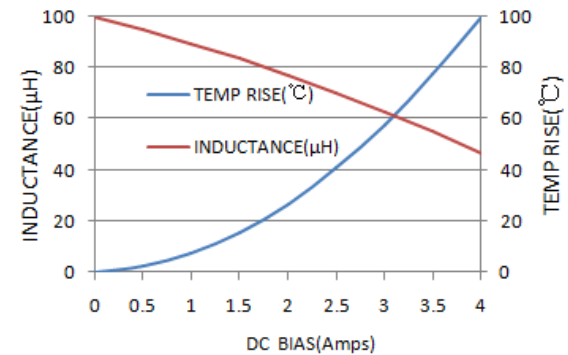
**MCMB-1040-8R2MT**

**MCMB-1040-100MT**

**MCMB-1040-150MT**

**MCMB-1040-220MT**

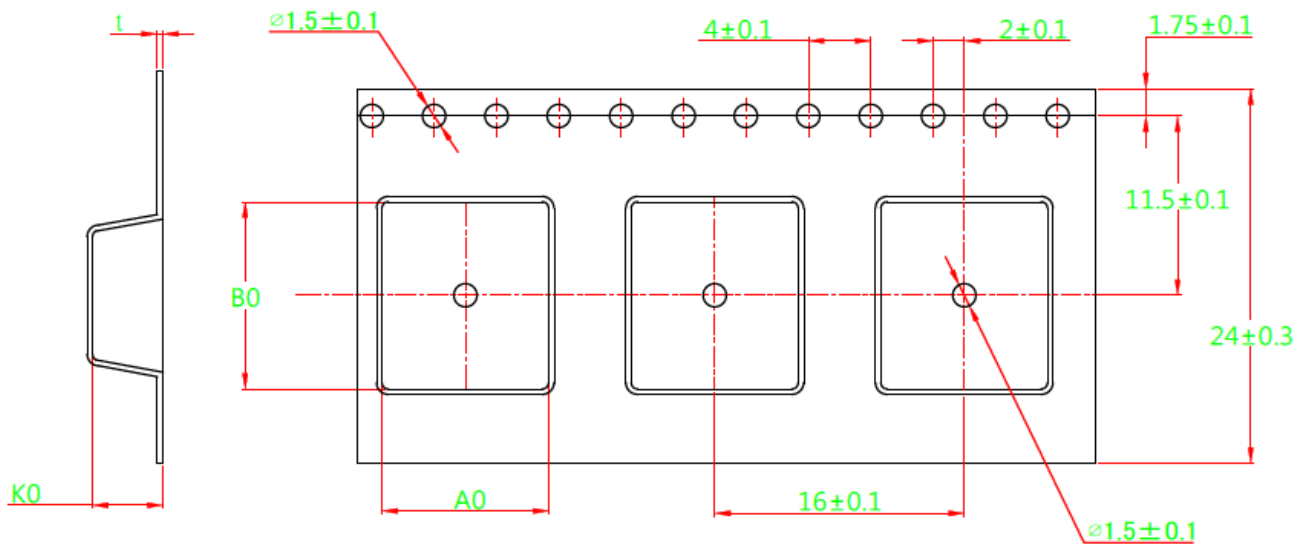
**MCMB-1040-330MT**

**MCMB-1040-470MT**

**MCMB-1040-680MT**

**MCMB-1040-101MT**

## Reliability and Test Condition

| Mechanical Reliability      |   |  |
|-----------------------------|---|--|
| Item                        | Specification and Requirement   | Test Method  |
| Solderability               | The surface of terminal immersed shall be minimum of 95% covered with a new coating of solder | Solder heat proof:<br>1. Preheating: $160 \pm 10$ °C<br>2. Retention time: $245 \pm 5$ °C for $2 \pm 0.5$ seconds  |
| Vibration                   | Inductance change: Within $\pm 10\%$<br>Without mechanical damage such as break               | 1. Vibration frequency:<br>(10 Hz to 55 Hz to 10Hz) in 60 seconds as a period<br>2. Vibration time:<br>Period cycled for 2 hours in each of 3 mutual perpendicular directions.<br>3. Amplitude: 1.5 mm max.  |
| Shock                       | Inductance change: Within $\pm 10\%$ Without mechanical damage such as break                  | 1. Peak value: 100 G<br>2. Duration of pulse: 11ms<br>3. 3 times in each positive and negative direction of 3 mutual perpendicular directions  |
| Endurance Reliability       |   |  |
| Item                        | Specification and Requirement   | Test Method  |
| Thermal Shock               | Inductance change: Within $\pm 10\%$<br>Without distinct damage in appearance                 | 1. Repeat 100 cycles as follow:<br>( $-55 \pm 2$ °C; $30 \pm 3$ min)<br>→(Room temp., 5 min)<br>→ ( $+125 \pm 2$ °C, $30 \pm 3$ min)<br>→ (Room temp., 5 min)<br>2. Recovery: $48 + 4 / -0$ hours of recovery under the standard condition after the test. |
| High Temperature Resistance | Inductance change: Within $\pm 10\%$<br>Without distinct damage in appearance                 | 1. Environment condition: $85 \pm 2$ °C<br>Applied Current: Rated current<br>2. Duration: $1000 + 4 / -0$ hours  |
| Humidity Resistance         | Inductance change: Within $\pm 10\%$<br>Without distinct damage in appearance                 | 1. Environment condition: $60 \pm 2$ °C<br>Humidity: 90–95%<br>Applied Current: Rated current<br>2. Duration: $1000 + 4 / -0$ hours  |
| Low Temperature Store       | Inductance change: Within $\pm 10\%$<br>Without distinct damage in appearance                 | Store temperature:<br>$-55 \pm 2$ °C, $1000 + 4 / -0$ hours  |
| High Temperature Store      | Inductance change: Within $\pm 10\%$<br>Without distinct damage in appearance                 | Store temperature:<br>$+125 \pm 2$ °C, $1000 + 4 / -0$ hours   |

## Tape Packaging Dimensions



| A0              | B0              | K0            | t                |
|-----------------|-----------------|---------------|------------------|
| $10.7 \pm 0.10$ | $12.0 \pm 0.10$ | $4.5 \pm 0.1$ | $0.35 \pm 0.025$ |

## Reel Dimensions

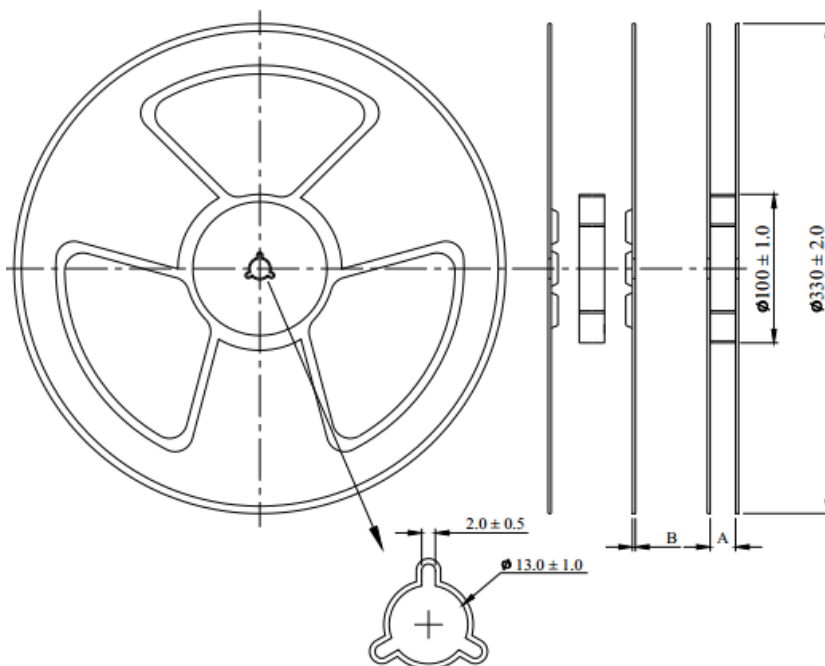

|    | A              | B             |
|----|----------------|---------------|
| mm | $24.5 \pm 0.2$ | $2.0 \pm 0.2$ |

**Packaging Quantity:1000PCS/Reel**

## Recommended Soldering Technologies

### (1) Re-flowing Profile

Preheat condition: 150 ~200°C/60~180sec.

Allowed time above 217°C: 80~120sec.

Max temp: 260°C

Max time at max temp: 10 sec.

Solder paste: Sn/3.0Ag/0.5Cu

Allowed Reflow time: 2x max

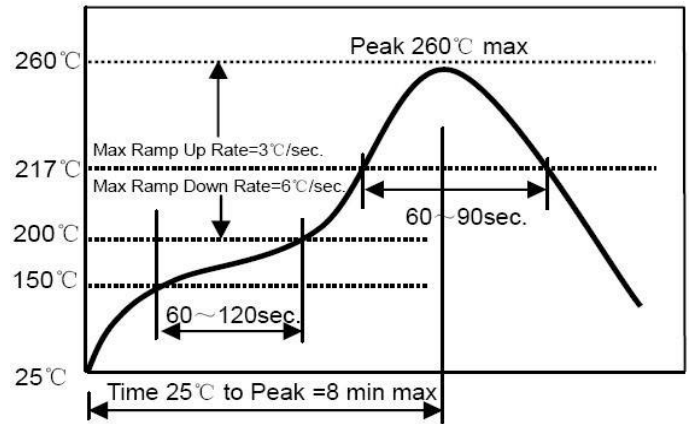

### (2) Iron Soldering Profile

Iron soldering power: Max.

30W Pre-heating: 150°C/60sec.

Soldering time: 3sec. Max.

Solder paste: Sn/3.0Ag/0.5Cu

Max.1 times for iron soldering

