

**Product Summary**

Symbol	Value	Unit
$I_{T(RMS)}$	0.8	A
$V_{DRM} V_{RRM}$	600 / 800	V
$V_{TM}$	1.55	V

**Feature**

With high ability to withstand the shock loading of large current, With high commutation performances, 4 quadrants products especially recommended for use on inductive load.

**Application**

Washing machine, vacuums, massager, solid state relay, AC Motor speed regulation and so on.

**Package**

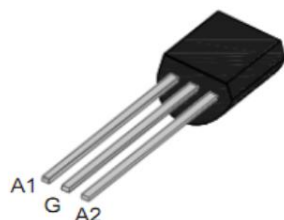

**TO-92**

**Circuit diagram**

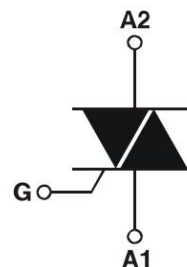

**Marking**

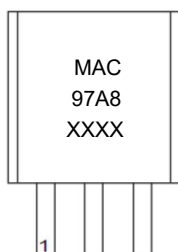

### Absolute maximum ratings (Ta=25°C unless otherwise noted)

Parameter	Symbol	Value	Unit	
Repetitive peak off-state voltage	V <sub>DRM</sub>	600 / 800	V	
Repetitive peak reverse voltage	V <sub>RPM</sub>	600 / 800	V	
RMS on-state current	I <sub>T(RMS)</sub>	0.8	A	
Non repetitive surge peak on-state current (full cycle, F=50Hz)	I <sub>TSM</sub>	8	A	
I <sup>2</sup> t value for fusing (tp=10ms)	I <sup>2</sup> t	0.32	A <sup>2</sup> s	
Critical rate of rise of on-state current (I <sub>G</sub> = 2 × I <sub>GT</sub> )	di/dt	I - II - III	50	A/μs
		IV	10	
Peak gate current	I <sub>GM</sub>	1	A	
Average gate power dissipation	P <sub>G(AV)</sub>	0.5	W	
Junction Temperature	T <sub>J</sub>	-40 ~ +125	°C	
Storage Temperature	T <sub>STG</sub>	-40 ~ +150	°C	

### Electrical characteristics (T<sub>A</sub>=25 °C, unless otherwise noted)

Parameter	Symbol	Test Condition	Value	Unit		
Gate trigger current	I <sub>GT</sub>	V <sub>D</sub> = 12V I <sub>T</sub> = 0.1A T <sub>J</sub> = 25°C	I - II - III	5	mA	
			IV	7		
Gate trigger voltage	V <sub>GT</sub>	I - II - III - IV	MAX.	1.2	V	
Gate non-trigger voltage	V <sub>GD</sub>	V <sub>D</sub> = V <sub>DRM</sub> T <sub>J</sub> = 125°C	MIN.	0.2	V	
latching current	I <sub>L</sub>	V <sub>D</sub> = 12V I <sub>GT</sub> = 0.1A T <sub>J</sub> = 25°C	I - III - IV	10	mA	
			II	15		
Holding current	I <sub>H</sub>	I - II - III - IV	MAX.	10	mA	
Critical-rate of rise of commutation voltage	dV/dt	V <sub>D</sub> = 2/3V <sub>DRM</sub> Gate Open T <sub>J</sub> = 125°C	MIN.	30	V/μs	
<b>STATIC CHARACTERISTICS</b>						
Forward "on" voltage	V <sub>TM</sub>	I <sub>TM</sub> = 1.2A tp = 380μs	MAX.	1.55	V	
Repetitive Peak Off-State Current	I <sub>DRM</sub>	V <sub>D</sub> = V <sub>DRM</sub> V <sub>R</sub> = V <sub>RPM</sub>	T <sub>J</sub> = 25°C	MAX.	5	μA
Repetitive Peak Reverse Current	I <sub>RPM</sub>		T <sub>J</sub> = 125°C	MAX.	100	μA
<b>THERMAL RESISTANCES</b>						
Thermal resistance	R <sub>th(j-c)</sub>	Junction to case(AC)	TYP.	60	°C/W	
	R <sub>th(j-a)</sub>	Junction to ambient	TYP.	150	°C/W	

**Typical Characteristics**

FIG.1: Maximum power dissipation versus RMS on-state current (full cycle)

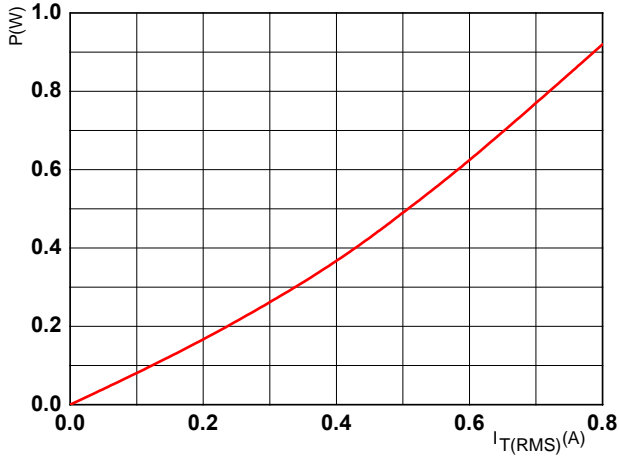

FIG.2: RMS on-state current versus case temperature (full cycle)

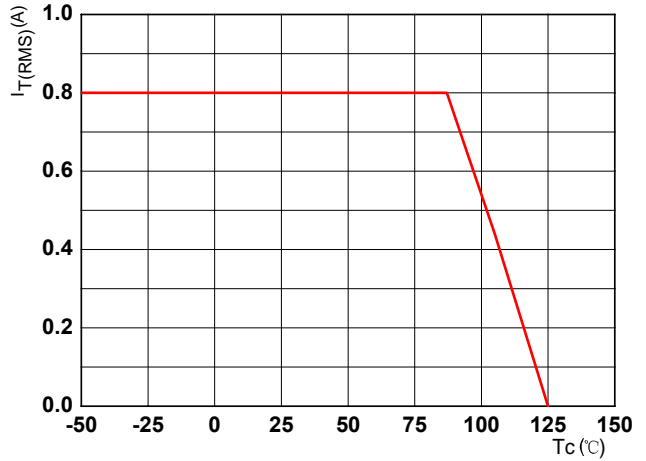

FIG.3: Surge peak on-state current versus number of cycles

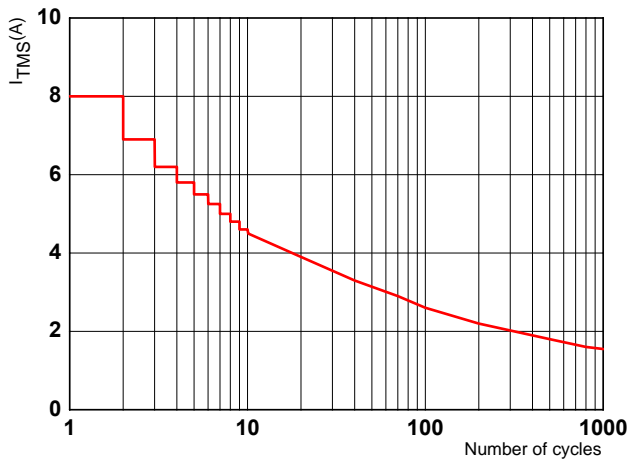

FIG.4: On-state characteristics (maximum values)

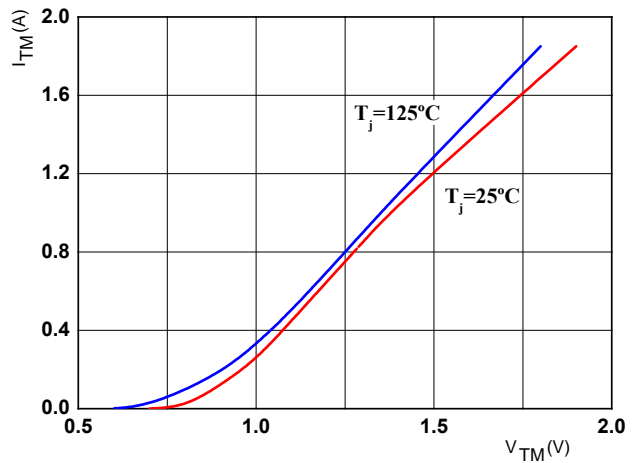

FIG.5: Non-repetitive surge peak on-state current for a sinusoidal pulse with width tp < 10ms

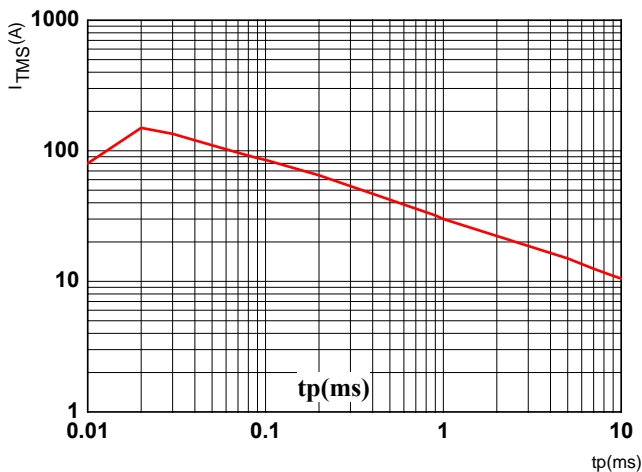
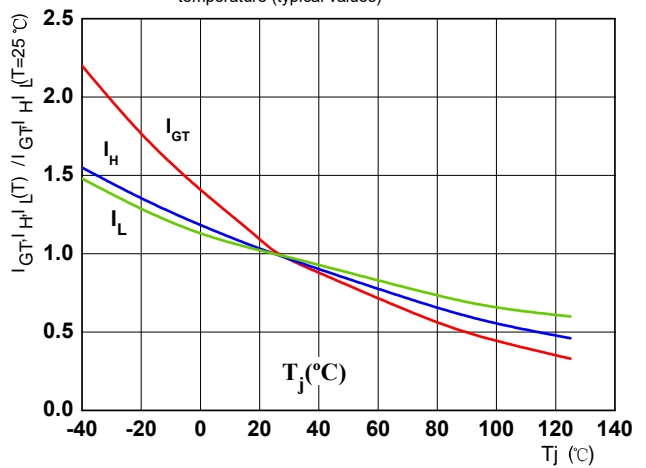
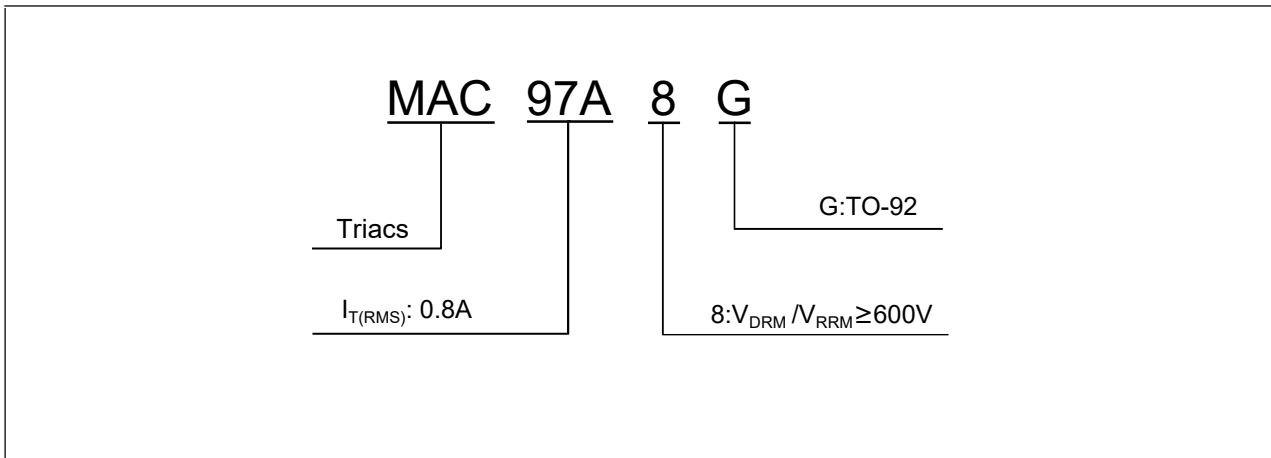

FIG.6: Relative variations of gate trigger current, holding current and latching current versus junction temperature (typical values)



**Ordering Information**



**TO-92 Package Information**

Ref.	Dimensions					
	Millimeters			Inches		
	Min.	Typ.	Max.	Min.	Typ.	Max.
A	4.45		5.20	0.175		0.205
B	4.32		5.33	0.170		0.210
C	3.18		4.19	0.125		0.165
D	0.407		0.533	0.016		0.021
E	0.60		0.80	0.024		0.031
F	-	1.1	-	-	0.043	-
G	-	1.27	-	-	0.050	-
H	-	2.30	-	-	0.091	-
J	0.36		0.50	0.014		0.020
K	12.70		15.0	0.500		0.591
N	2.04		2.66	0.080		0.105
P	1.86		2.06	0.073		0.081
V	-		4.3	-		0.169