

# 产品规格书

<b>SAP料号</b> SAP part No. :	<b>10205E6805A32001A0</b>
<b>产品型号</b> Product P/N :	<b>SK6805D-EC3227-000</b>
<b>样品号</b> SAP part No. :	<b>EP00022B-000</b>
<b>客户料号</b> Client P/N :	<b>NA</b>
<b>版本号</b> Version No.:	<b>A1</b>
<b>时间</b> Sending Date :	<b>2025-08-14</b>

Customer approval			Opsco approval		
CHECK	APPROVE	CONFIRM	DRAW	CHECK	APPROVE
			雷梁晨	周凯	朱更生
Stamp			Stamp		



\*使用我司产品前, 请检索我司官网核对规格书版本, 产品规格书版本更新, 恕不能及时相告, 请以官网最新资料为准。

\*Before using our products, please search our official website to verify the version of the specification sheet. The product specification sheet version is updated, and we apologize for any inconvenience caused. Please refer to the latest information on the official website for accuracy.

\*该版权及产品最终解释权归广东欧思科科技股份有限公司所有, 如有特殊规格要求, 请联系我司工程人员。

\*The copyright and final interpretation rights of the product belong to GuangDong OPSCO Technology Co., Ltd. If there are special specification requirements, please contact our engineering personnel.

## 目录 Catalogue

1、产品概述 Overview .....	3
2、主要应用 Main applications .....	3
3、产品命名一般说明 General instructions for product naming .....	3
4、机械尺寸 Mechanical dimensions .....	4
5、引脚功能说明 Pin Function Description .....	4
6、PCB建议焊盘尺寸 PCB recommended pad size .....	5
7、IC极限参数 IC limit parameter .....	5
8、GRB LED光电参数 GRB LED Optoelectronic parameters .....	6
9、IC电气参数 IC electrical parameters .....	6
10、数据传输时间 Data transmission time .....	7
11、数据传输方式 Data transmission method .....	7
12、时序波形图 Time series waveform diagram .....	8
13、24bit数据结构 24 bit data structure .....	9
14、典型应用电路 Typical application circuit .....	9
15、光电特性 Photoelectric characteristic .....	10
16、包装标准 Packaging standards .....	11
17、可靠性测试 Reliability testing .....	12

## 1. 产品概述 Product overview:

- 工作电压: 5V@5mA(OUT GRB);  
Forward voltage: 5V@5mA (OUT GRB);
- 发光角度: 160°;  
Luminescent angle: 160°;
- 胶体颜色: 雾状不透明;  
Colloid color: Misty opaque;
- 内置复位电路, 上电不亮灯;  
Built-in reset circuit, power does not light;
- 灰度调节: 256级;  
Grayscale adjustment: 256 levels;
- 单线归零码传输协议, 可无限级联;  
Single-line zero code transmission protocol, can be infinite cascade;
- 数据传输频率可达800Kbps, 当刷新速率30帧/秒时, 级联数不小于1024点;  
The data transmission frequency can reach 800Kbps, and when the refresh rate is 30 frames per second, the number of cascades is not less than 1024 points;
- 湿敏等级: 4;  
MSL: 4;
- 静电ESD: 2KV;  
ESD level: 2KV;
- 符合RoHS REACH;  
RoHS and REACH-compliant;

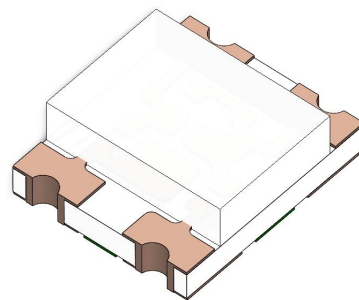

## 2. 主要应用 Main applications:

- 消费电子产品  
Consumer electronics

## 3. 产品命名一般说明 General instructions for product naming:

# SK 6805 D-EC3227-000

①                  ②                  ③                  ④                  ⑤

①	②	③	④	⑤
系列 Series	IC系列与电流代码 IC series and current codes	胶体状态 Colloidal state	封装外形 Package outline	内部编码 Internal code
默认为GRB晶片与 IC集成在一起 Default to GRB chip integrated with IC	6805: 指68系列IC; 5mA电流版本 6805: Refers to the 68 series IC; 5mA current version	D表示: 雾状不透明 D represents: foggy opacity	3.2x2.7x1.08毫米 PCB支架封装 3.2x2.7x1.08mm PCB holder package	000:流水号 000: Serial number

#### 4. 机械尺寸 Mechanical dimensions:

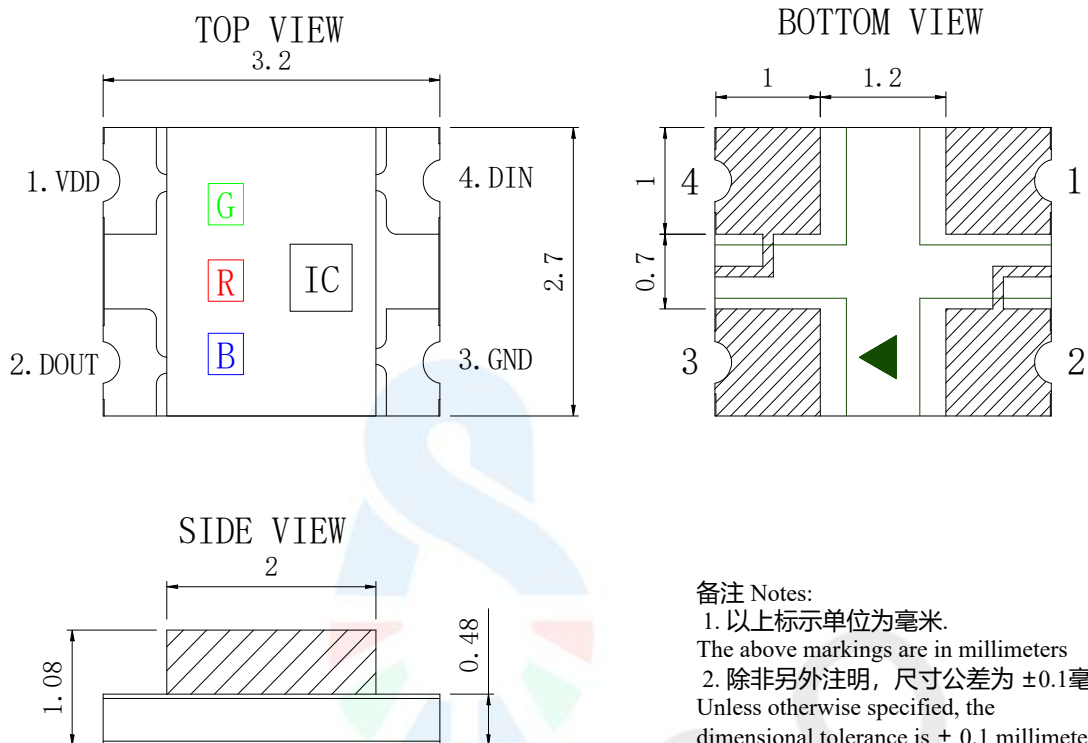

#### 5. 引脚功能说明 Pin Function Description:

序号 Serial Number	符号 Symbol	管脚名 Pin name	功能描述 Function Description
1	VDD	电源 Power supply	供电管脚 Power supply pins
2	DOUT	数据输出 Data output	控制数据信号输出 Control data signal output
3	GND	地 Grounds	电源接地 Power grounding
4	DIN	数据输入 Data input	控制数据信号输入 Control data signal input

6. PCB建议焊盘尺寸 PCB recommended pad size: (以实际使用情况为准 Based on actual usage)

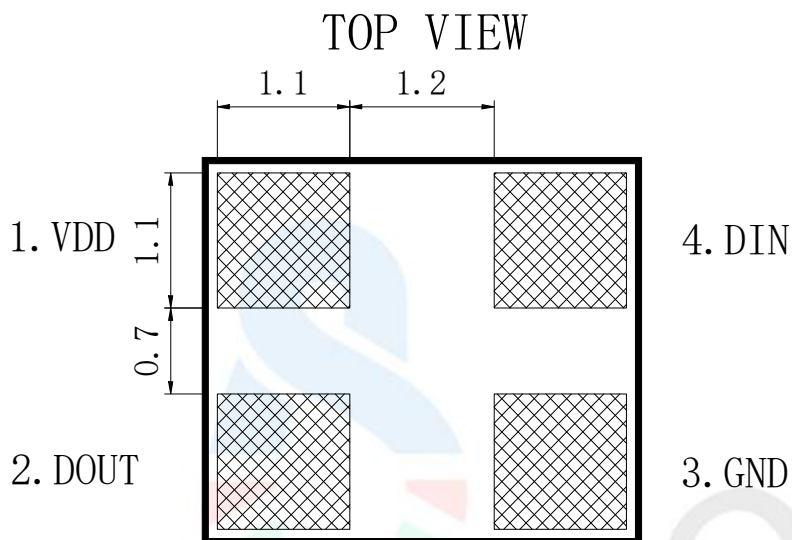

7. IC极限参数 IC limit parameter : (Ta=25°C)

参数 Parameter	符号 Symbol	范围 Range	单位 Unit
逻辑电源电压 Working voltage	VDD	3.7~5.5	V
工作温度 Operation temperature	Topt	-40~+80	°C
储存温度 Storage temperature	Tstg	-40~+80	°C
ESD耐压 (人体模式) ESD withstand voltage (human mode)	VESD	2K	V

## 8. GRB LED 光电参数 Optoelectronic parameters:

颜色 Colour	SK6805D-EC3227-000 5mA	
	波长 (nm) Wavelength (nm)	亮度 (mcd) Brightness (mcd)
绿色 (GREEN)	525-535	240-450
红色 (RED)	615-625	80-160
蓝色 (BLUE)	465-475	70-140

## 9. IC电气参数 IC electrical parameters: (TA=25°C)

参数 Parameter	符号 Symbol	最小 Minimum	典型 Typical	最大 Maximum	单位 Unit	测试条件 Test conditions
工作电压 Chip input voltage	VDD	3.7	5	5.5	V	---
信号输入翻转阈值 Signal input flip threshold	VIH	0.65VDD	---	---	V	DIN 输入高电平 DIN input high level
	VIL	---	---	0.3VDD	V	DIN 输入低电平 DIN input low level
G/R/B输出驱动电流 G/R/B output drive current	IDOUT	4.5	5	6	mA	V <sub>DS</sub> =1V
PWM频率 PWM frequency	F <sub>PWM</sub>	---	4.5	---	KHz	---
静态功耗 Static power consumption	I <sub>DD</sub>	---	0.3	---	mA	---
数据传输速率 Transfer rate	F <sub>DIN</sub>	---	800	---	Kbps	---

### 10. 控制器建议数据传输时间 Suggested data transmission time:

时序表名称 Timeline Name		Min.	实际值 Actual value	Max.	单位 Unit
T	码元周期 Symbol period	0.90	1.20	20	us
T0H	0码, 高电平时间 0 code, high-level time	0.20	0.30	0.40	us
T0L	0码, 低电平时间 0 code, low-level time	0.70	0.90	--	us
T1H	1码, 高电平时间 1 code, high-level time	0.70	0.90	--	us
T1L	1码, 低电平时间 1 code, low-level time	0.20	0.30	--	us
Reset	Reset码, 低电平时间 Reset code, low-level time	200	--	--	us

注1: 协议采用的是单极性归零码, 每一个码元都必须有低电平。本协议的每个码元起始为高电平, 高电平时间宽度决定“0”码或者“1”码。

注2: 上述为第一颗芯片 DI 输入的数据通信协议时间要求。需按照上表的规定的码元时间范围来进行控制程序的设计, 重点注意0码高电平不得高于 0.4us, 1码高电平不得低于 0.7us。

Note 1: The protocol uses unipolar return-to-zero codes, and each code element must have a low level. Each code element of this protocol starts at a high level, high

The level time width determines whether it is "0" code or "1" code.

Note 2: The above is the time requirement for the data communication protocol of the first chip DI input. The control program needs to be carried out in accordance with the code element time range specified in the above table

In the design, it is important to note that the 0-bit high level must not exceed 0.4us and the 1-bit high level must not be lower than 0.7us.

### 11. 数据传输方式 Data transmission method: (Ta=25°C)

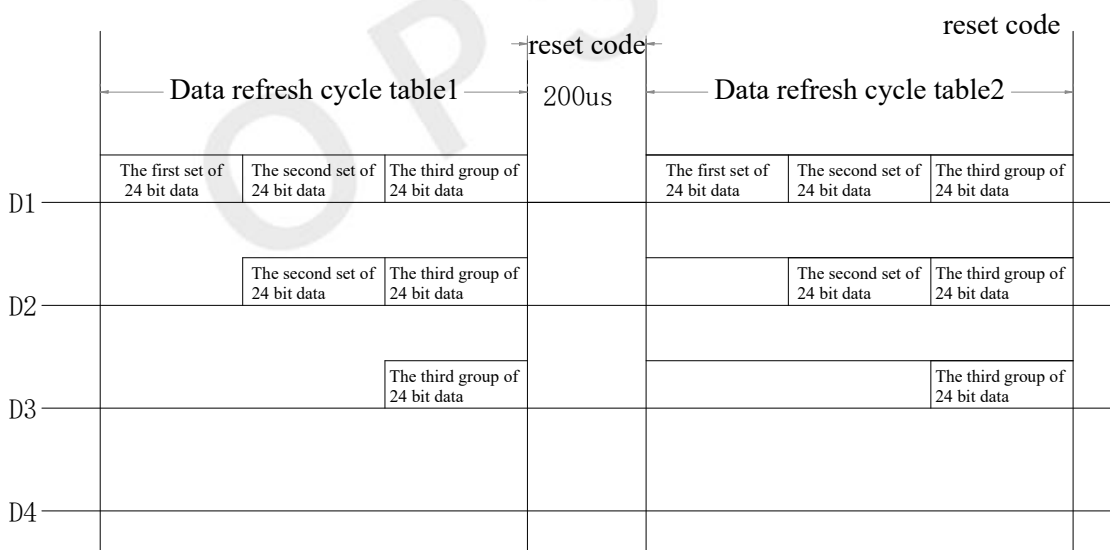

注Note: 其中D1为MCU端发送的数据, D2、D3、D4为级联电路自动整形转发的数据。

Among them, D1 is the data sent by the MCU end, and D2, D3, and D4 are the data automatically shaped and forwarded by the cascaded circuit.

## 12. 时序波形图 Time series waveform diagram: (Ta=25°C)

输入码型 Input code type:

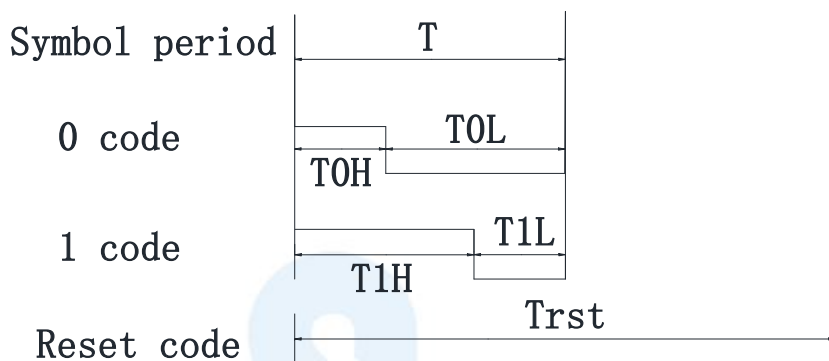

连接方式 Connection method:

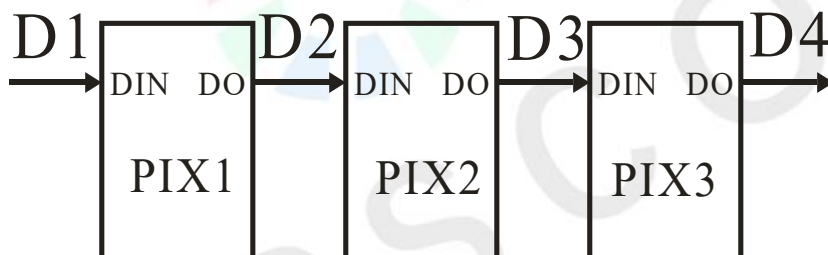

### 13. 24bit数据结构 24 bit data structure: (Ta=25°C)

G7	G6	G5	G4	G3	G2	G1	G0	R7	R6	R5	R4
R3	R2	R1	R0	B7	B6	B5	B4	B3	B2	B1	B0

注Note: 高位先发, 按照GRB的顺序发送数据(G7 → G6 →…….B0)

High bit first send, send data in GRB order (G7 → G6 →.... B0)

### 14. 典型应用电路 Typical application circuit:

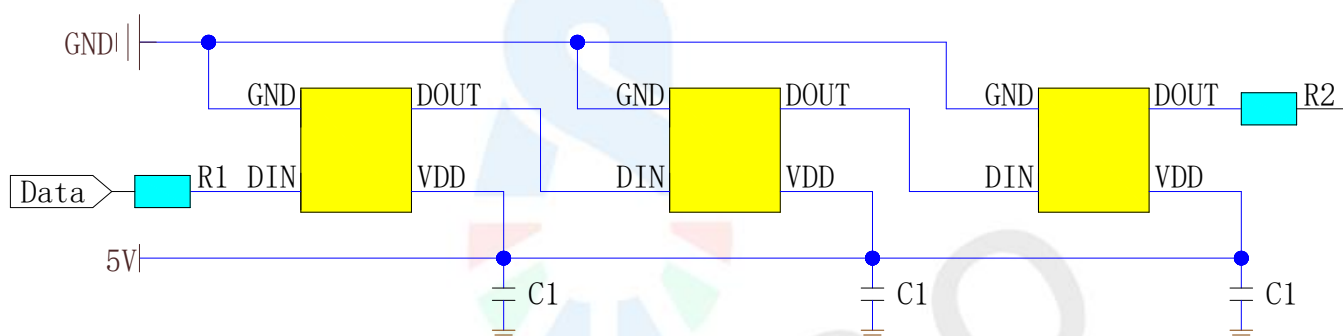

在实际应用电路中, 为防止产品在测试时带电插拔产生的瞬间高压损伤IC内部信号输入输出引脚, 应在信号输入及输出端串接保护电阻。此外, 为了使各IC芯片间更稳定工作, 各灯珠间的退偶电容则必不可少;

- 应用一: 用于软灯条或硬灯条的, 灯珠间传输距离短的, 建议在信号输入输出端各串接保护电阻, 即R1=R2约500欧; 以实际使用情况定;
- 应用二: 用于模组或一般异形产品, 灯珠间传输距离长, 因线材及传输距离不同, 在信号两端串接的保护电阻会略有不同; 以实际使用情况定;

In practical application circuits, to prevent instantaneous high voltage damage to the internal signal input and output pins of the IC caused by live plugging and unplugging during testing, protective resistors should be connected in series at the signal input and output terminals. In addition, in order to ensure more stable operation between IC chips, the decoupling capacitance between each LED is essential;Based on actual usage;

- Application 1: For soft or hard light strips with short transmission distance between lamp beads, it is recommended to connect protective resistors in series at the signal input and output terminals, that is, R1=R2, about 500 ohms;
- Application 2: Used for modules or For general shaped products, the transmission distance between lamp beads is long. Due to different wire materials and transmission distances, the protective resistance connected in series at both ends of the signal will be slightly different; Based on actual usage;

### 15. 光电特性 Photoelectric characteristic:

焊盘温度与光通量输出的相对关系  
 The relative relationship between pad temperature and luminous flux output

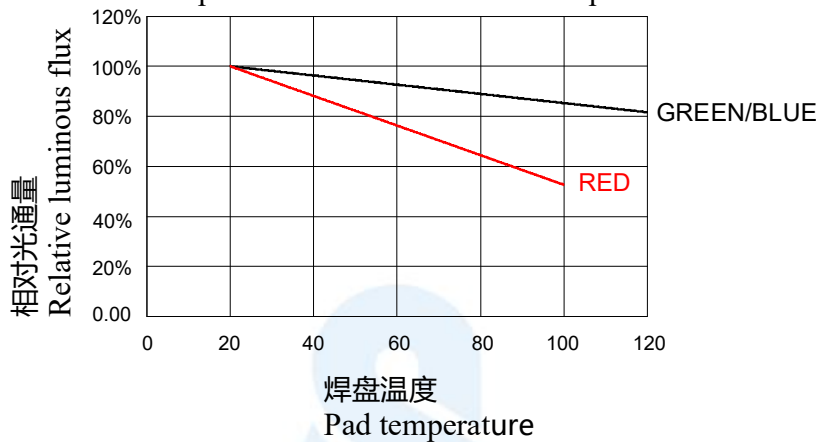

波长特性  
 Wavelength characteristics

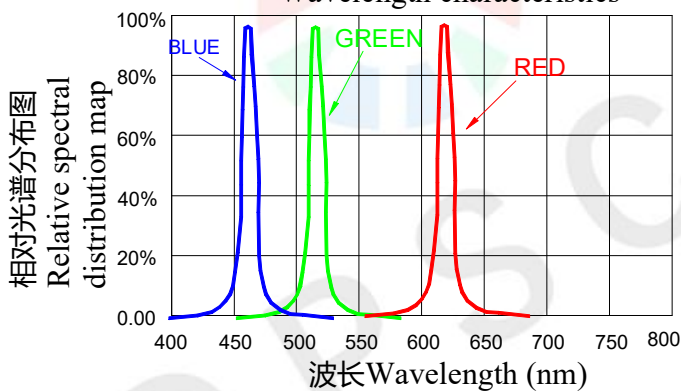

典型的辐射方向图 160°  
 Typical radiation pattern 160°

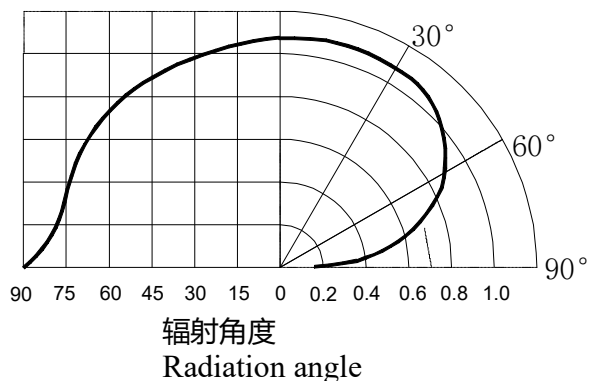

## 16. 包装标准 Packaging standards:

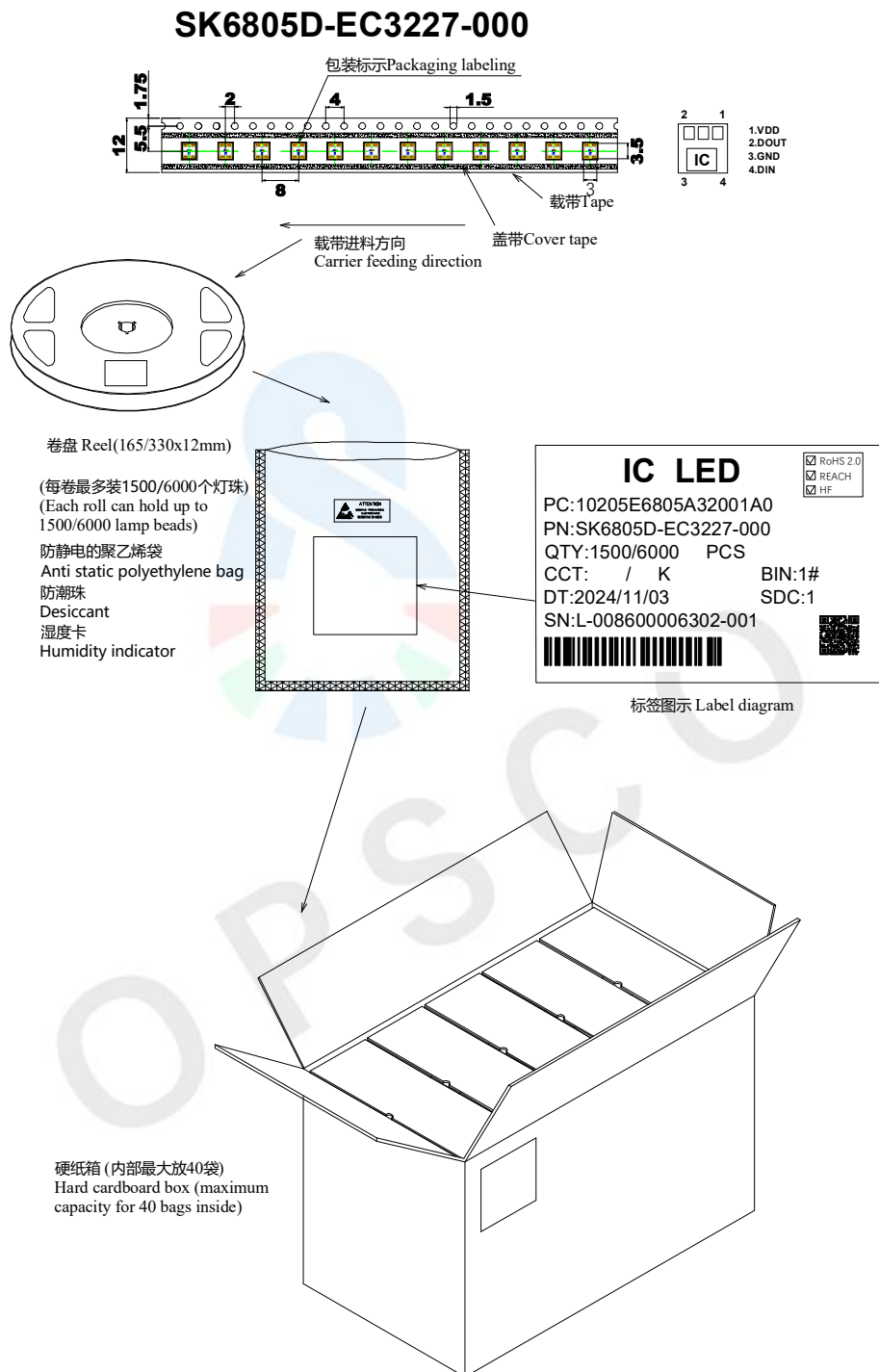

表面贴装LED采用卷盘包装，LED在用普通或防静电袋包装后再装在纸箱中。纸箱用于保护运输途中LED不受机械冲击，纸箱不防水，因此请注意防潮防水。

Surface mounted LEDs are packaged in rolls, and the LEDs are packaged in regular or anti-static bags before being packed in cardboard boxes. The cardboard box is used to protect the LED from mechanical impact during transportation. The cardboard box is not waterproof, so please pay attention to moisture-proof and waterproof.

## 17. 可靠性测试 Reliability testing:

序号 Serial Number	实验项目 Pilot projects	实验条件 Experimental condition	参考标准 Reference standards	判断 Determine
1	冷热冲击 Thermal Shock	100 ± 5°C ~ -40°C ± 5°C 15min~15min 100cycles	MIL-STD-202G	0/22
2	高温储藏 High temperature storage	Ta= +100°C 1000hrs	JEITA ED-4701 200 201	0/22
3	低温储藏 Low temperature storage	Ta= -40°C 1000hrs	JEITA ED-4701 200 202	0/22
4	高温高湿储藏 High temperature and high humidity storage	Ta=60°C RH=90% 1000hrs	JEITA ED-4701 100 103	0/22
5	温度循环 Temperature cycling	-40°C~25°C~100°C~25°C 30min~5min~30min~5min 100 cycles	JEITA ED-4701 100 105	0/22
6	耐焊接热 Resistance to Soldering Heat	Tsld = 260°C, 10sec. 2 times	JEITA ED-4701 300 301	0/22
7	常温寿命测试 Normal temperature life test	25°C, IF: Typical current , 1000hrs	JESD22-A 108D	0/22

## 失效判定标准 Failure criteria:

项目 Project	符号 Symbol	测试条件 Test conditions	判断标准 Judgment criteria	
			最小值 Minimum value	最大值 Maximum value
发光强度 Intensity	IV	DC=5V,规格典型电流 DC=5V, typical current specification	初始数据X0.7 Initial data X0.7	---
耐焊接热 Resistance to Soldering Heat	---	DC=5V,规格典型电流 DC=5V, typical current specification	无死灯或明显损坏 No dead lights or obvious damage	

