

FEATURES

- * Low forward voltage drop
- * High current capability
- * High reliability
- * High surge current capability
- * Epitaxial construction

MECHANICAL DATA

- * Case: Molded plastic
- * Epoxy: UL 94V-0 rate flame retardant
- * Lead: Axial leads, solderable per MIL-STD-202, method 208 guaranteed
- * Polarity: Color band denotes cathode end
- * Mounting position: Any
- * Weight: 1.10 grams

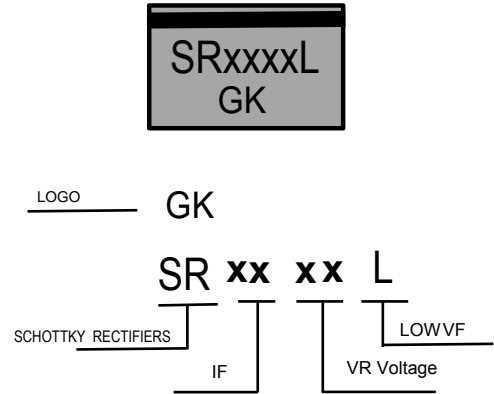

VOLTAGE RANGE

45 to 100 Volts

CURRENT

10.0 Ampere

MAXIMUM RATINGS AND ELECTRICAL CHARACTERISTICS

Rating 25°C ambient temperature unless otherwise specified.
Single phase half wave, 60Hz, resistive or inductive load.
For capacitive load, derate current by 20%.

TYPE NUMBER	SR1045L	SR1060L	SR10100L	UNITS
Maximum Recurrent Peak Reverse Voltage	45	60	100	V
Maximum RMS Voltage	32	42	70	V
Maximum DC Blocking Voltage	45	60	100	V
Maximum Average Forward Rectified Current See Fig. 1	10.0			A
Peak Forward Surge Current, 8.3 ms single half sine-wave superimposed on rated load (JEDEC method)	150			A
Maximum Instantaneous Forward Voltage at 10.0A	0.47	0.57	0.67	V
Maximum DC Reverse Current at Rated DC Blocking Voltage	200			μA
	20			mA
Typical Junction Capacitance (Note1)	670			pF
Typical Thermal Resistance R _{JA} (Note 2)	20			°C/W
Operating Temperature Range T _J	-55 to +150			°C
Storage Temperature Range T _{STG}	-55 to +150			°C

NOTES:

1. Measured at 1MHz and applied reverse voltage of 4.0V D.C.
2. Thermal Resistance Junction to Ambient Vertical PC Board Mounting 0.375"(9.5mm) Lead Length.

RATING AND CHARACTERISTIC CURVES

FIG.1-TYPICAL FORWARD CURRENT DERATING CURVE

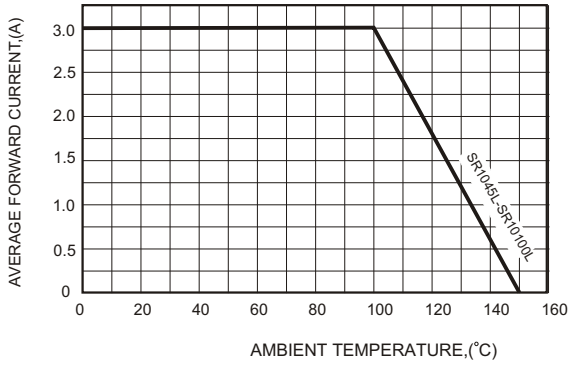

FIG.2-TYPICAL FORWARD CHARACTERISTICS

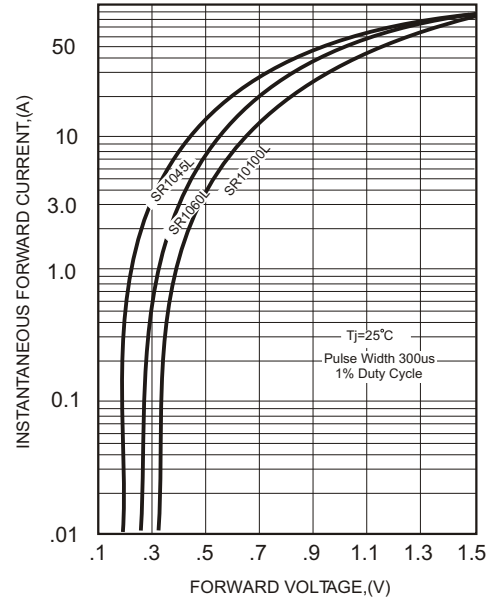

FIG.3-MAXIMUM NON-REPETITIVE FORWARD SURGE CURRENT

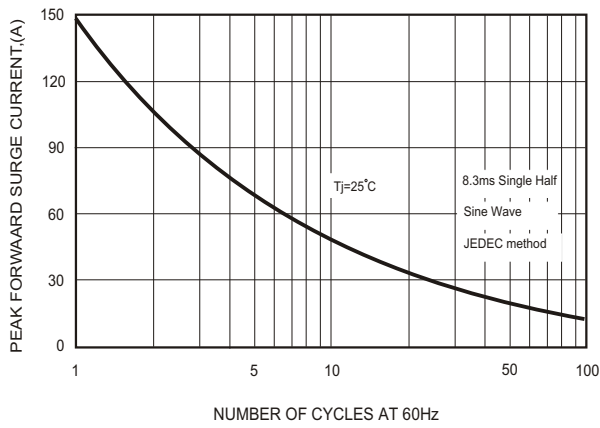

FIG.4 - TYPICAL REVERSE CHARACTERISTICS

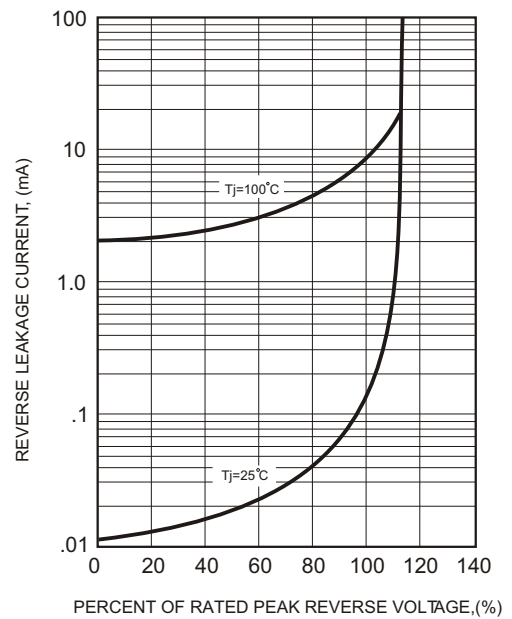
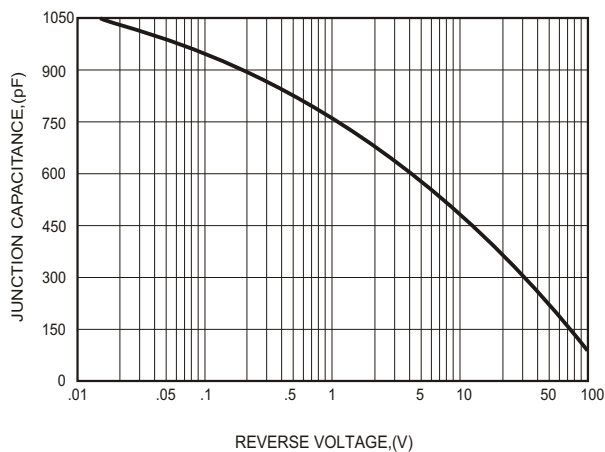

FIG.5-TYPICAL JUNCTION CAPACITANCE



Soldering parameters

Reflow Condition		Pb-Free assembly (see as below)
Pre Heat	-Temperature Min ($T_{s(min)}$)	+150 °C
	-Temperature Max ($T_{s(max)}$)	+200 °C
	-Time (Min to Max) (ts)	60-180 secs.
Average ramp up rate (Liquid us Temp (T_L) to peak)		3 °C/sec. Max
$T_{s(max)}$ to T_L - Ramp-up Rate		3 °C/sec. Max
Reflow	-Temperature (T_L) (Liquid us)	+217 °C
	-Temperature (t_L)	60-150 secs.
Peak Temp (T_p)		+260(+0/-5) °C
Time within 5 °C of actual Peak Temp (t_p)		30 secs. Max
Ramp-down Rate		6 °C/sec. Max
Time 25 °C to Peak Temp (T_p)		8 min. Max
Do not exceed		+260 °C



Package Dimensions & Suggested Pad Layout

DO-27

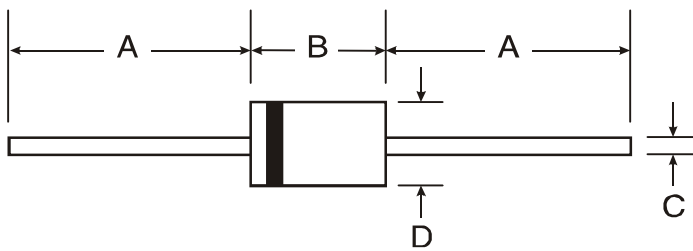

DO-27		
Dim	Min	Max
A	24.00	-
B	7.20	9.50
C	1.15	1.25
D	5.00	5.60
All Dimensions in mm		