

Features

- Low Dropout Voltage.
- Load regulation: 0.5% Max.
- Optimized for Low Voltage
- On-chip thermal limiting.
- Maximum Input Voltage : 18V
- Adjustable Output Voltage or Fixed 1.2V,
1.5V, 1.8V, 2.5V, 3.3V,5V
- Standard SOT-223,TO-252 ,SOT89
- Packages

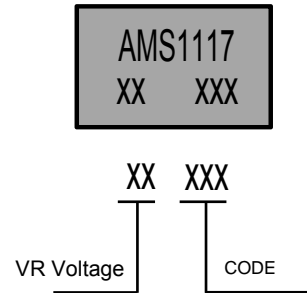

Applications

- Post Regulator for switching DC/DC Converter
- High Efficiency Linear Regulator
- Battery Chargers
- PC Add on Card
- Motherboard clock supplies
- LCD Monitor r
- Set-top Box

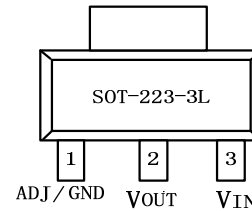

MAXIMUM RATINGS AND ELECTRICAL CHARACTERISTICS

Absolute Maximum Ratings

Symbol	Description	Max	Units
VIN	Input Voltage	18	V
IOUT	DC Output Current	PD/(VIN-VOUT)	mA
TJ	Operating Junction Temperature Range	-40 to 125	°C
θ JA	Thermal Resistance (SOT-223)	150	°C/W
θ JA	Thermal Resistance (TO-252)	125	°C/W
θ JA	Thermal Resistance (SOT89)	225	°C/W
PD	Maximum Power Dissipation (SOT-223)	600	mW
PD	Maximum Power Dissipation (TO-252)	900	mW
PD	Maximum Power Dissipation (SOT89)	400	mW

Electrical Characteristics

($V_{in} < 7V$, $T_j = 25^\circ C$ unless otherwise Specified. The ~ denotes specifications which apply over the specified operating temperature range.)

Parameter	Conditions	Min.	Typ.	Max.	Units
Reference voltage	$V_{IN} = V_{out} + 2V$, $10mA \leq I_{OUT} \leq 1A$ AMS1117-ADJ	1.225(-2%)	1.250	1.275(+2%)	V
Output voltage	$10mA \leq I_{OUT} \leq 1A$, $V_{IN} = V_{out} + 2V$				V
	AMS1117-1.2	1.176	1.20	1.224	
	AMS1117-1.5	1.470	1.50	1.530	
	AMS1117-1.8	1.764	1.80	1.836	
	AMS1117-2.5	2.450	2.50	2.550	
	AMS1117-3.3	3.234	3.30	3.366	
	AMS1117-5.0	4.90	5.0	5.10	
Line regulation ^{1,2}	$(V_{OUT} + 1.5V) \leq V_{IN} \leq 12V$, $I_{OUT} = 10mA$		0.15	0.30	%
Load regulation ^{1,2}	$(V_{IN} - V_{OUT}) = 2V$, $10mA \leq I_{OUT} \leq 1A$		0.20	0.50	%
Dropout voltage	$V_{REF} = 1%$, $I_{OUT} = 1A$		1.30	1.40	V
Current limit	$(V_{IN} - V_{OUT}) = 2V$	1			A
Adjust pin current	AMS1117-ADJ $1.5V \leq (V_{IN} - V_{OUT}) \leq 7V$, $10mA \leq I_{OUT} \leq 1A$		50	120	μA
Minimum load current	$1.5V \leq (V_{IN} - V_{OUT}) \leq 12V$		3	10	mA
Quiescent current	$V_{IN} = V_{OUT} + 1.25V$		3	10	mA
Ripple rejection	$f = 120Hz$, $C_{out} = 22\mu F$ Tantalum, $(V_{IN} - V_{OUT}) = 3V$, $I_{out} = 1A$	60	70		dB
Thermal regulation	$T_A = 25^\circ C$, 30ms pulse		0.008	0.04	%/W
Temperature stability			0.5		%
Long-term stability	$T_A = 125^\circ C$, 1000hrs.		0.3	1.0	%
RMS output noise (%of V_{OUT})	$T_A = 25^\circ C$, $10Hz \leq f \leq 10kHz$		0.003		%
Thermal resistance, junction to case	SOT-223		15		$^\circ C / W$
	TO-252		10		$^\circ C / W$
	SOT89		20		$^\circ C / W$
Thermal shutdown	Junction temperature		150		$^\circ C$
Thermal shutdown hysteresis			10		$^\circ C$

- 1、 See thermal regulation specifications for changes in output voltage due to heating effects. Load and line regulation are measured at a constant junction temperature by low duty cycle pulse testing.
- 2、 Line and load regulation are guaranteed up to the maximum power dissipation (1.2W). Power dissipation is determined by input/output differential and the output current. Guaranteed maximum output power will not be available over the full input/ output voltage range.
- 3、 Output current must be limited to meet the absolute maximum ratings of the part.

RATING AND CHARACTERISTIC CURVES

Line regulation

AMS1117-ADJ Vout Vs. Vin

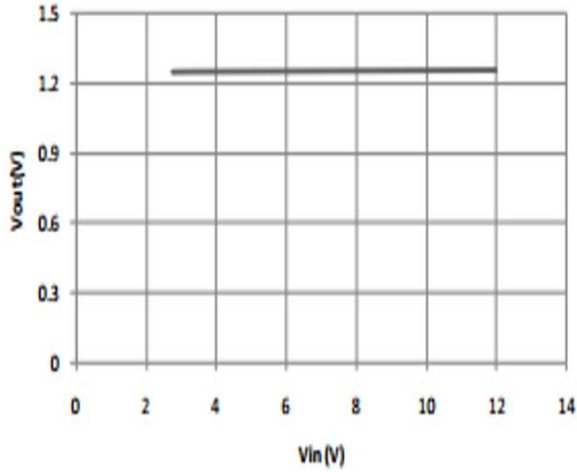

Dropout Voltage

AMS1117 Dropout Voltage

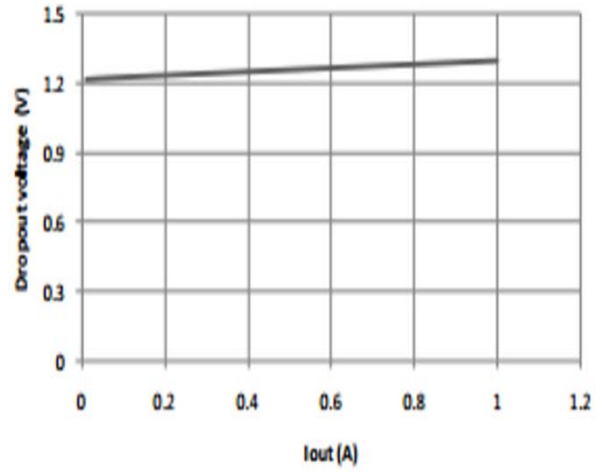

Load regulation

AMS1117-ADJ Vout Vs. Iout

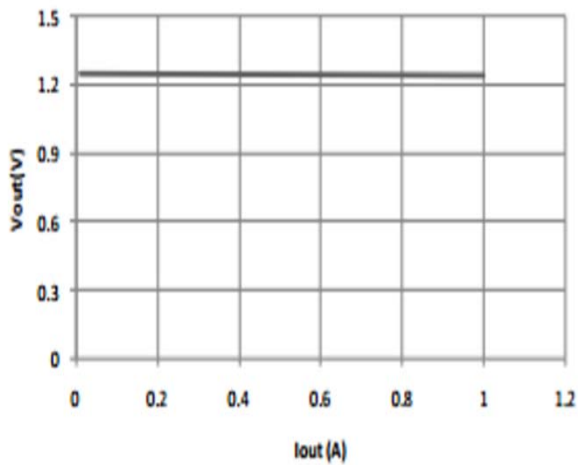

Thermal performance with OTP

AMS1117 Thermal performance with OTP

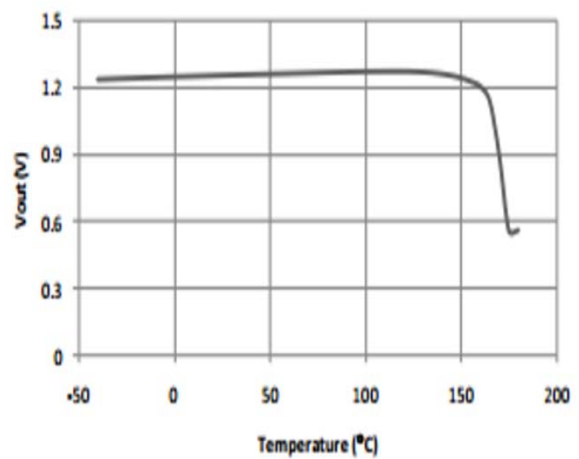

Soldering parameters

Reflow Condition		Pb-Free assembly (see as below)
Pre Heat	-Temperature Min ($T_{s(min)}$)	+150 °C
	-Temperature Max($T_{s(max)}$)	+200 °C
	-Time (Min to Max) (ts)	60-180 secs.
Average ramp up rate (Liquid us Temp (T_L) to peak)		3 °C/sec. Max
$T_{s(max)}$ to T_L - Ramp-up Rate		3 °C/sec. Max
Reflow	-Temperature(T_L)(Liquid us)	+217 °C
	-Temperature(t_L)	60-150 secs.
Peak Temp (T_P)		+260(+0/-5) °C
Time within 5 °C of actual Peak Temp (t_p)		30 secs. Max
Ramp-down Rate		6 °C/sec. Max
Time 25 °C to Peak Temp (T_P)		8 min. Max
Do not exceed		+260 °C



Package Dimensions & Suggested Pad Layout

SOT-223

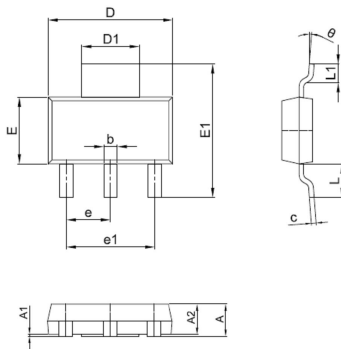

Symbol	Millimeter		Inches	
	Min.	Max.	Min.	Max.
A	1.50	1.80	0.059	0.071
A1	0.00	0.10	0.000	0.004
A2	1.50	1.70	0.059	0.067
b	0.65	0.75	0.026	0.030
c	0.20	0.30	0.008	0.012
D	6.40	6.60	0.252	0.260
D1	2.90	3.10	0.114	0.122
E	3.30	3.70	0.130	0.146
E1	6.85	7.15	0.270	0.281
e	2.20	2.40	0.087	0.094
e1	4.40	4.80	0.173	0.189
L	1.65	1.85	0.065	0.073
L1	0.90	1.15	0.035	0.045

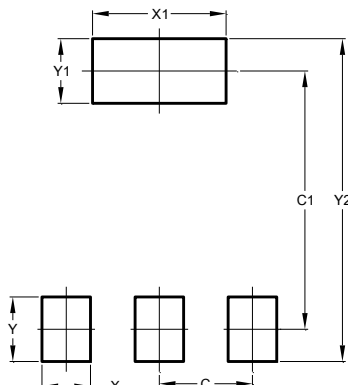

Dimensions	Value (in mm)
C	2.30
C1	6.00
X	1.20
X1	3.60
Y	1.70
Y1	1.70
Y2	7.70

Tape & reel specification

Tape		Symbol	Dimension (mm)
		P0	4.00±0.20
		P1	8.00±0.20
		P2	2.00±0.20
		D0	1.55±0.20
		D1	1.55±0.20
		E	1.75±0.20
		F	5.50±0.20
		W	12.00±0.20
		A0	7.40±0.20
		B0	7.50±0.20
		K0	2.10±0.20
		T	0.20±0.20
		D2	330.0±5.0
		D3	100.0±4.0
		W1	18.0±5.0
W2	22.0±5.0		
I	13.0±2.0		
Quantity: 2500PCS			

13" Reel

