

Features

- 4.5 to 15-V Single Supply Range
- Outputs Held Low During VDD UVLO
- TTL and CMOS Compatible Input-Logic Threshold
- Input Design Output Held Low when Input Pins are Floating
- Fast Rise and Fall Times (9ns and 7ns typical)
- Fast Propagation Delays (13ns typical)
- Split Output Configuration
- Strong Sink Current Offers Enhanced Immunity Against Miller Turn on
- Input Pins Capable of Withstanding - 5 V Below GND pin
- Compact package: SOP-8

Applications

- DC-to-DC Converters
- Desktop PC Power
- Switch-Mode Power Supplies
- Companion Gate-Driver Devices for Digital Power Controllers
- Gate Driver for Emerging Wide Band-Gap Power Devices (such as GaN)

General Description

The device is a compact gate driver that offers superior replacement of NPN and PNP discrete driver (buffer circuit) solutions. driver rated for MOSFETs, IGBTs, and emerging wide-bandgap power devices such as GaN. suitable for high-speed applications. Its asymmetrical 3-A peak source and 6-A peak sink currents boost immunity against parasitic Miller turn on effect. Features including wide input hysteresis and negative input voltage handling enhance transient immunity.

Pin out (top view)

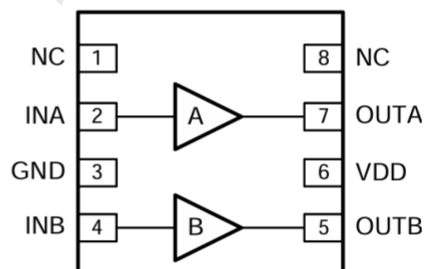

DUAL NONINVERTING

Pin Configurations

Pin	Name	Function
1	NC	N/C No internal connection
2	INA	Channel A Logic Input
3	GND	Ground,Common ground reference for input and output circuits.
4	INB	Channel B Logic Input
5	OUTB	Channel B Output - Sources or sinks current to turn-on or turn-off a discrete MOSFET or IGBT.
6	VDD	Supply Voltage.
7	OUTA	Channel A Output - Sources or sinks current to turn-on or turn-off a discrete MOSFET or IGBT.
8	N/A	N/C No internal connection

Absolute Maximum Ratings (Note1)

Description	Min	Max	Unit
Supply Voltage, VDD	-0.3	18	V
Output Voltage, OUT	-0.3	18	V
Input, IN	-6.0	18	V
Output continuous source current	0.3		A
Output continuous sink current	0.6		A
Output pulsed (0.5us) source current	3.0		A
Output pulsed (0.5us) sink current	6.0		A
Junction Temperature	125		°C
Storage Temperature	-40	150	°C
Lead Temperature (Soldering, 10s)	300		°C

Note 1: Absolute Maximum Ratings are those values beyond which the life of a device may be impaired.

Recommended Operating Conditions

Description	Min	Max	Unit
Supply Voltage, VDD	4.5	15	V
Input, IN	-5.0	15	V
Operating Junction Temperature	0	125	°C

Internal Block Diagram

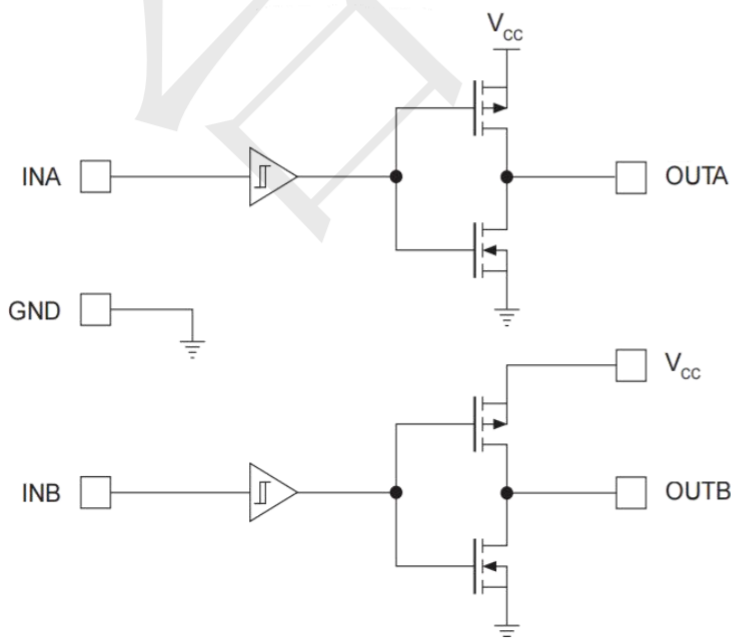

OUTPUT LOGIC

IN _x	OUT _x
0	0
1	1

Electrical Characteristics (VDD=12V, T_J=25°C, unless otherwise specified)

Parameter	Symbol	Test Conditions	Min	Typ	Max	Units
Startup Current	I _{START}	VDD=3.4V, IN+=VDD, IN-=GND	40	100	160	uA
		VDD=3.4V, IN+=IN-=GND	25	75	145	
		VDD=3.4V, IN+=GND, IN-=VDD	20	60	115	
VDD Start Threshold	V _{ON}		3.9	4.2	4.5	V
VDD OFF Threshold	V _{OFF}		3.0	3.5	4.0	V
VDD Hysteresis	V _{HYS}			0.7		V
Input Signal High Threshold	V _{H(IN)}		--	2.4	2.6	V
Input Signal Low Threshold	V _{L(IN)}		1.0	1.2	--	V
Source Peak Current	I _{PSRC}	C _{load} =0.22uF, f _S =1kHz	--	-3	--	A
Sink Peak Current	I _{PSNK}	C _{load} =0.22uF, f _S =1kHz	--	6	--	A
High Output Voltage	V _{OH}	VDD=12V, I _{OUTH} = -10mA	--	50	90	mV
		VDD=4.5V, I _{OUTH} = -10mA	--	60	130	mV
Low Output Voltage	V _{OL}	VDD=12V, I _{OUTL} = 10mA	--	5	6.5	mV
		VDD=4.5V, I _{OUTL} = 10mA	--	5.5	10	mV
Output Pullup Resistance	R _{OH}	VDD=12V, I _{OUTH} = -10mA	--	5	7.5	Ω
		VDD=4.5V, I _{OUTH} = -10mA	--	5	11	Ω
Output Resistance Pulllow	R _{OL}	VDD=12V, I _{OUTL} = 10mA	--	0.375	0.65	Ω
		VDD=4.5V, I _{OUTL} = 10mA	--	0.45	0.75	Ω
Rise Time	T _{RISE}	VDD=12V, C _{LOAD} =1.8nF, OUTH, OUTL tied together	--	8	12	nS
		VDD=4.5V, C _{LOAD} =1.8nF, OUTH, OUTL tied together	--	16	22	nS
Fall Time	T _{FALL}	VDD=12V, C _{LOAD} =1.8nF, OUTH, OUTL tied together	--	7	11	nS
		VDD=4.5V, C _{LOAD} =1.8nF, OUTH, OUTL tied together	--	7	11	nS
IN+ to output propagation delay	T _{DELAY+}	VDD=12V, C _{LOAD} =1.8nF, OUTH, OUTL tied together	9	23	33	nS
		VDD=4.5V, C _{LOAD} =1.8nF, OUTH, OUTL tied together	9	25	36	nS
IN- to output propagation delay	T _{DELAY-}	VDD=12V, C _{LOAD} =1.8nF, OUTH, OUTL tied together	9	23	33	nS
		VDD=4.5V, C _{LOAD} =1.8nF, OUTH, OUTL tied together	9	29	40	nS

Package Information

SOP-8

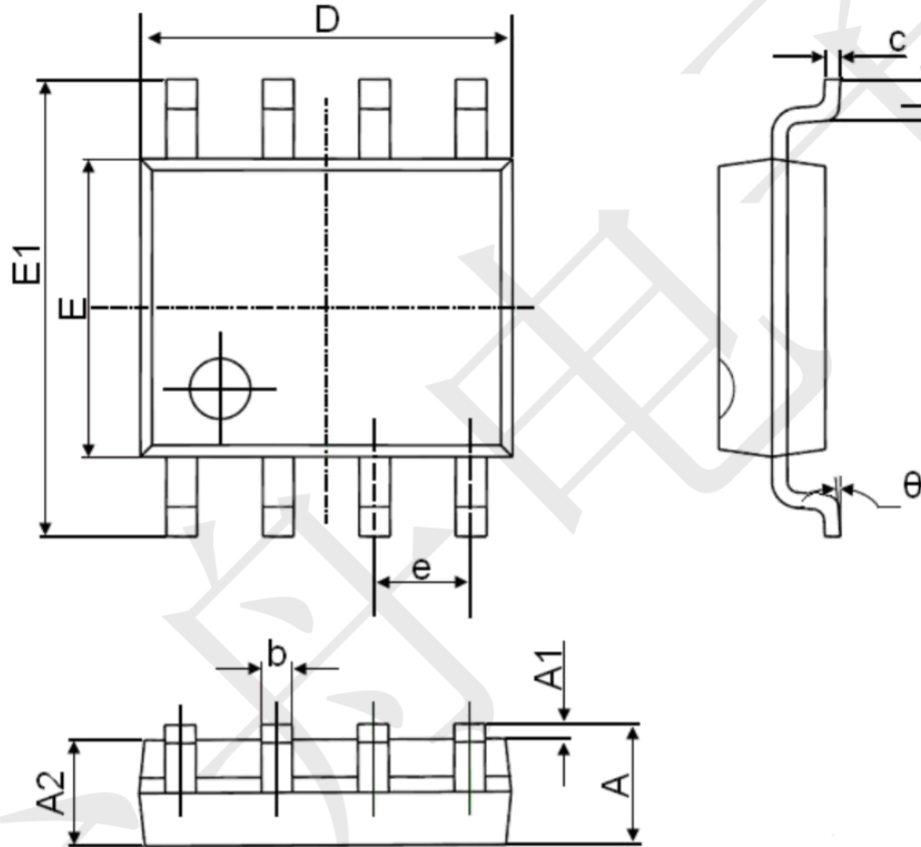

Symbol	Dimensions In Millimeters		Dimensions In Inches	
	Min.	Max.	Min.	Max.
A	1.350	1.750	0.053	0.069
A1	0.100	0.250	0.004	0.010
A2	1.350	1.550	0.053	0.061
b	0.330	0.510	0.013	0.020
c	0.170	0.250	0.006	0.010
D	4.700	5.100	0.185	0.200
E	3.800	4.000	0.150	0.157
E1	5.800	6.200	0.228	0.244
e	1.270(BSC)		0.050(BSC)	
L	0.400	1.270	0.016	0.050
θ	0°	8°	0°	8°