



Description

The IPD068P03L3G uses advanced trench technology

to provide excellent $R_{DS(ON)}$, low gate charge and

operation with gate voltages as low as 4.5V. This

device is suitable for use as a

Battery protection or in other Switching application.

General Features

$V_{DS} = -30V$ $I_D = -80A$

$R_{DS(ON)} < 8.8m\Omega @ V_{GS}=10V$

Application

Battery protection

Load switch

Uninterruptible power supply

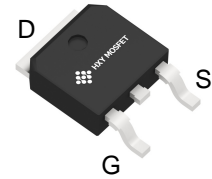

TO-252-2L
(TO-252-2(DPAK))

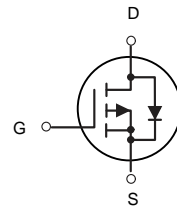

P-Channel MOSFET

Ordering Information

Product ID	Pack	Brand	Qty(PCS)
IPD068P03L3G	TO-252-2L(TO-252-2(DPAK))	HXY MOSFET	2500

Absolute Maximum Ratings ($T_C=25^\circ\text{C}$ unless otherwise noted)

Symbol	Parameter	Rating	Units
V_{DS}	Drain-Source Voltage	-30	V
V_{GS}	Gate-Source Voltage	± 20	V
$I_D@T_C=25^\circ\text{C}$	Continuous Drain Current, $V_{GS} @ -10V^1$	-80	A
$I_D@T_C=100^\circ\text{C}$	Continuous Drain Current, $V_{GS} @ -10V^1$	-42	A
I_{DM}	Pulsed Drain Current ²	-172	A
EAS	Single Pulse Avalanche Energy ³	31	mJ
I_{AS}	Avalanche Current	-25	A
$P_D@T_C=25^\circ\text{C}$	Total Power Dissipation ⁴	31.2	W
$P_D@T_A=25^\circ\text{C}$	Total Power Dissipation ⁴	2	W
T_{STG}	Storage Temperature Range	-55 to 150	$^\circ\text{C}$
T_J	Operating Junction Temperature Range	-55 to 150	$^\circ\text{C}$
$R_{\theta JA}$	Thermal Resistance Junction-Ambient ¹	43	$^\circ\text{C/W}$
$R_{\theta JC}$	Thermal Resistance Junction-Case ¹	4	$^\circ\text{C/W}$



Electrical Characteristics $T_c = 25^\circ\text{C}$, unless otherwise noted

Parameter	Symbol	Test Conditions	Min.	Typ.	Max.	Unit
Static Characteristics						
Drain-Source Breakdown Voltage	$V_{(BR)DSS}$	$V_{GS} = 0V, I_D = -250\mu A$	-30	-	-	V
Gate-body Leakage current	I_{GSS}	$V_{DS} = 0V, V_{GS} = \pm 20V$	-	-	± 100	nA
Zero Gate Voltage Drain Current	$T_J=25^\circ\text{C}$	$V_{DS} = -24V, V_{GS} = 0V$	-	-	-1	μA
	$T_J=55^\circ\text{C}$		-	-	-5	
Gate-Threshold Voltage	$V_{GS(th)}$	$V_{DS} = V_{GS}, I_D = -250\mu A$	-1.0	-1.6	-2.5	V
Drain-Source On-Resistance ²	$R_{DS(on)}$	$V_{GS} = -10V, I_D = -12A$	-	5.5	8.8	m Ω
		$V_{GS} = -4.5V, I_D = -8A$	-	9	14	
Forward Transconductance	g_{fs}	$V_{DS} = -5V, I_D = -20A$	-	28	-	S
Dynamic Characteristics						
Input Capacitance	C_{iss}	$V_{DS} = -15V, V_{GS} = 0V, f = 1\text{MHz}$	-	4320	-	pF
Output Capacitance	C_{oss}		-	529	-	
Reverse Transfer Capacitance	C_{rss}		-	487	-	
Switching Characteristics						
Gate Resistance	R_g	$V_{DS} = 0V, V_{GS} = 0V, f = 1.0\text{MHz}$	-	4.0	-	Ω
Total Gate Charge	Q_g	$V_{GS} = -10V, V_{DS} = -15V, I_D = -15A$	-	45	-	nC
Gate-Source Charge	Q_{gs}		-	8.5	-	
Gate-Drain Charge	Q_{gd}		-	12.8	-	
Turn-On Delay Time	$t_{d(on)}$	$V_{GS} = -10V, V_{DD} = -15V, R_G = 2.5\Omega, I_D = -15A$	-	18.9	-	nS
Rise Time	t_r		-	15.7	-	
Turn-Off Delay Time	$t_{d(off)}$		-	64.8	-	
Fall Time	t_f		-	36.5	-	
Drain-Source Body Diode Characteristics						
Diode Forward Voltage ²	V_{SD}	$I_S = -1A, V_{GS} = 0V$	-	-	-1	V
Continuous Source Current ^{1,5}	I_S	$V_G = V_D = 0V$, Force Current	-	-	-80	A

Note :

1. The data tested by surface mounted on a 1 inch² FR-4 board with 2OZ copper.
2. The data tested by pulsed, pulse width $\leq 300\mu s$, duty cycle $\leq 2\%$
3. The EAS data shows Max. rating. The test condition is $V_{DD} = -25V, V_{GS} = -10V, L = 0.1\text{mH}, I_{AS} = -25A$
4. The power dissipation is limited by 150 $^\circ\text{C}$ junction temperature
5. The data is theoretically the same as I_D and I_{DM} , in real applications, should be limited by total power dissipation.



Typical Characteristics

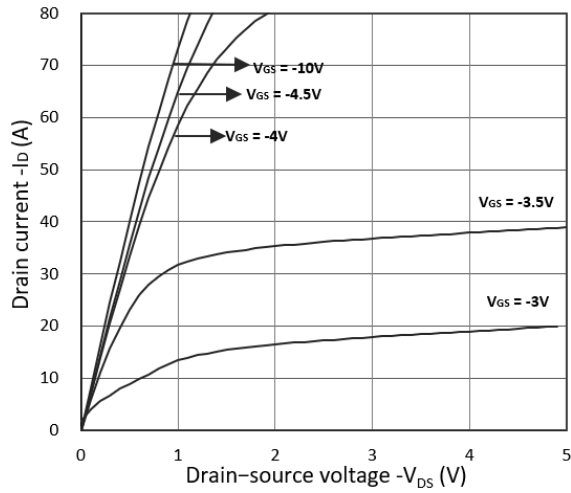

Figure 1. Output Characteristics

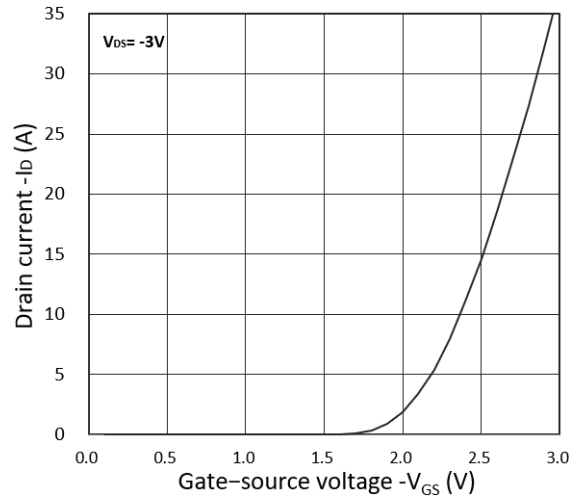

Figure 2. Transfer Characteristics

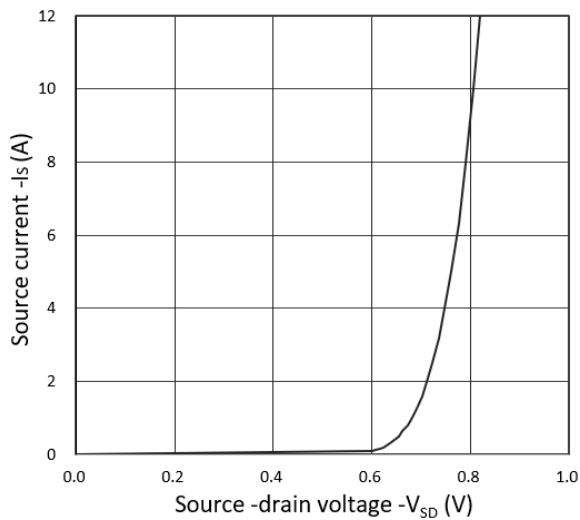

Figure 3. Forward Characteristics of Reverse

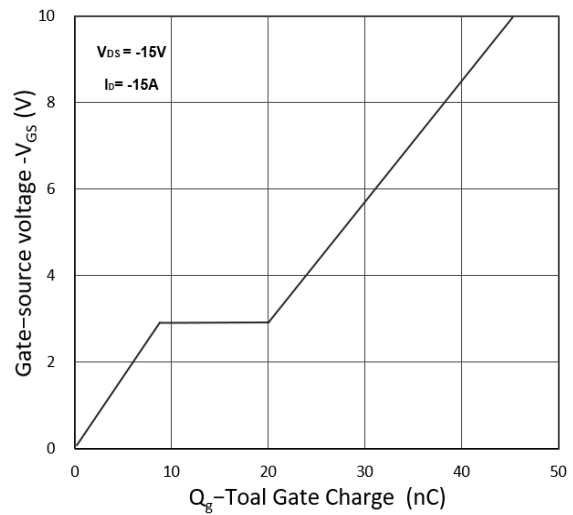

Figure 4. Gate Charge Characteristics

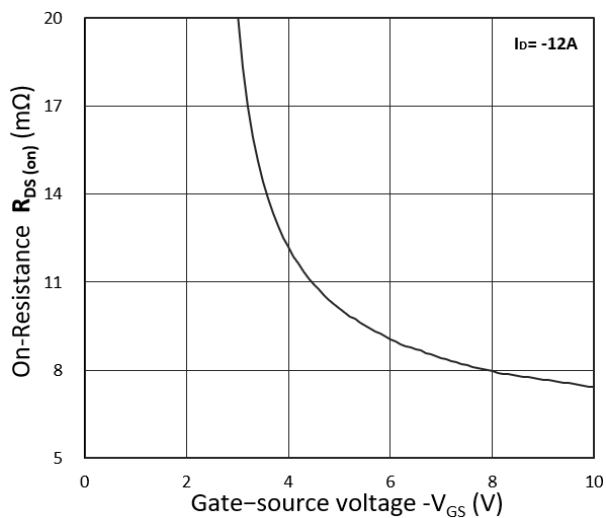

Figure 5. $R_{DS(on)}$ vs. V_{GS}

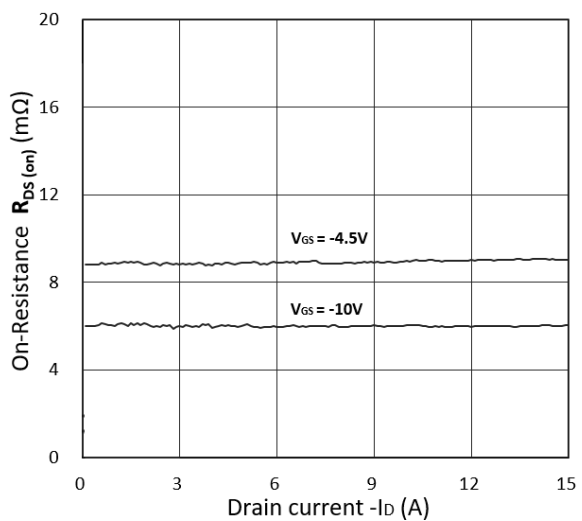

Figure 6. $R_{DS(on)}$ vs. I_D

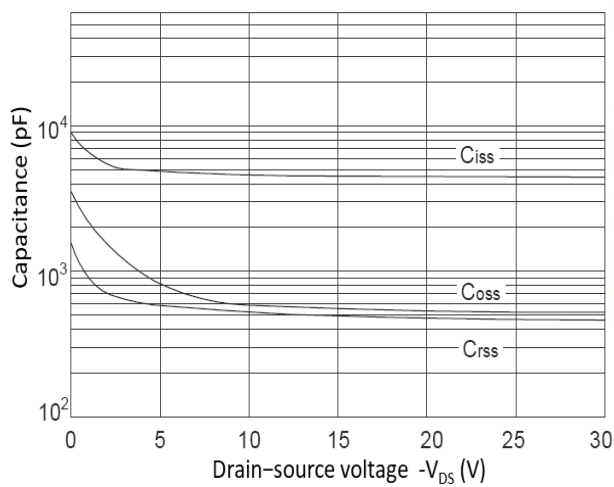

Figure 7. Capacitance Characteristics

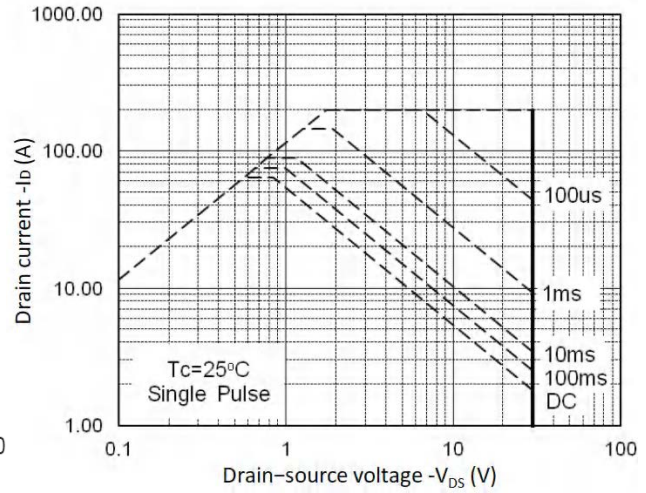

Figure 8. Safe Operating Area

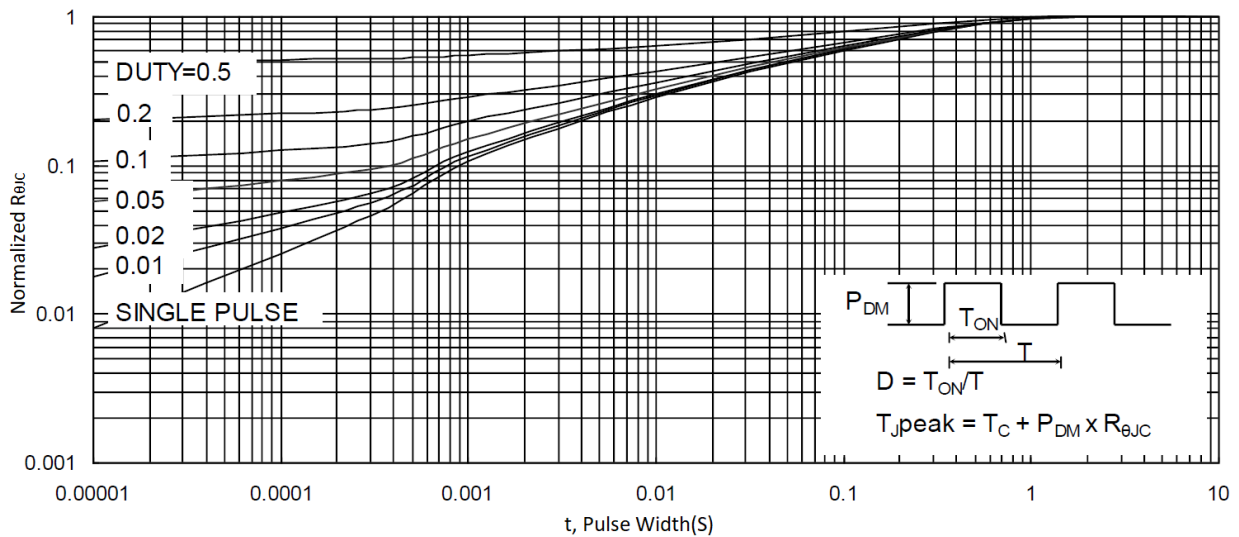

Figure 9. Normalized Maximum Transient Thermal Impedance

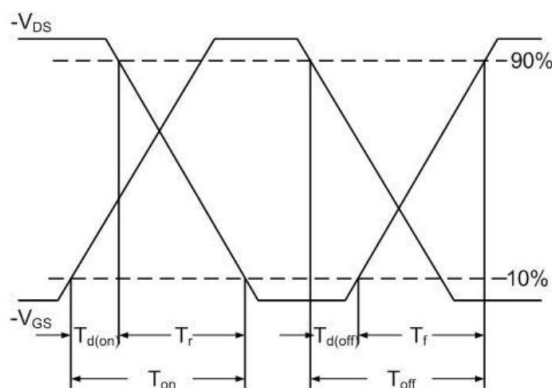

Figure 10. Switching Time Waveform

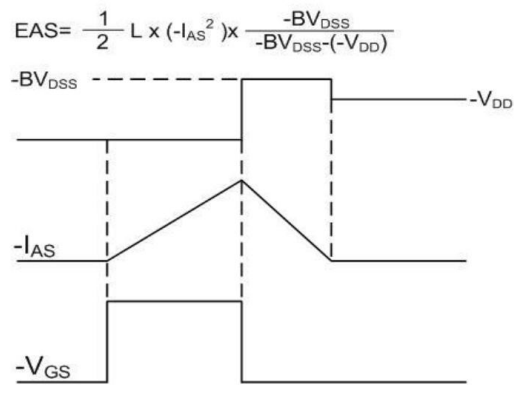
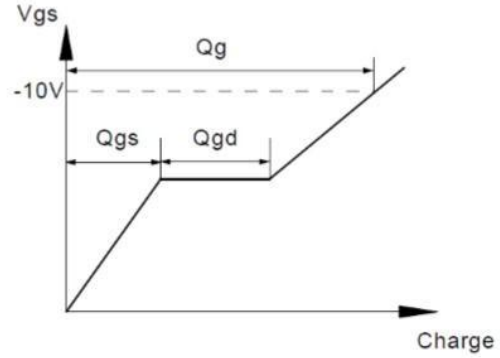
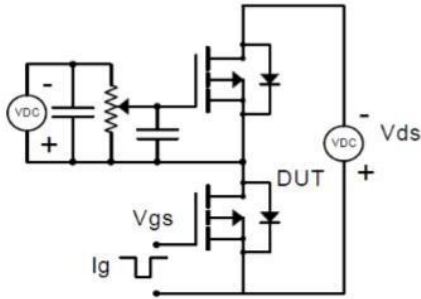

Figure 11. Unclamped Inductive Switching
Waveform



Test Circuit

Gate Charge Test Circuit & Waveform



Resistive Switching Test Circuit & Waveforms

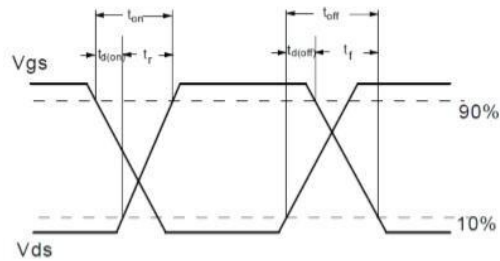
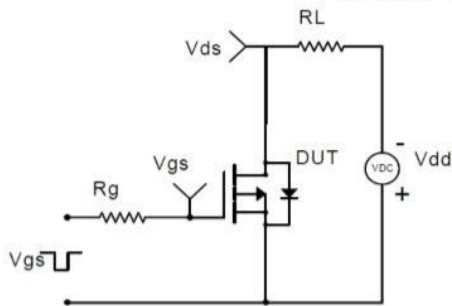

Unclamped Inductive Switching (UIS) Test Circuit & Waveforms

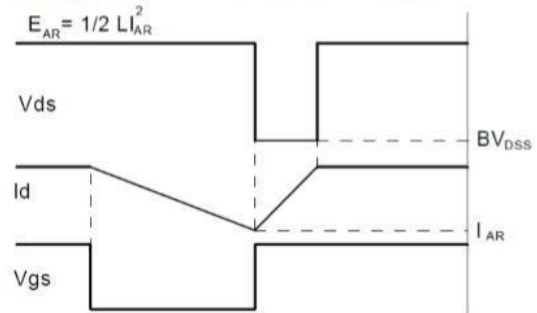
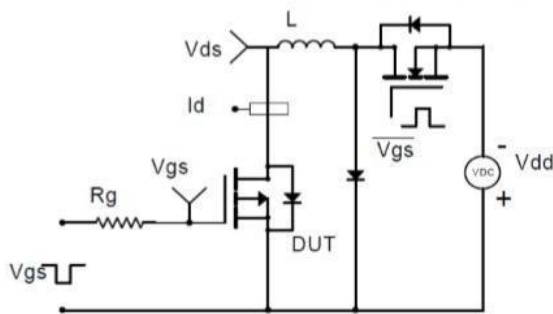

Diode Recovery Test Circuit & Waveforms

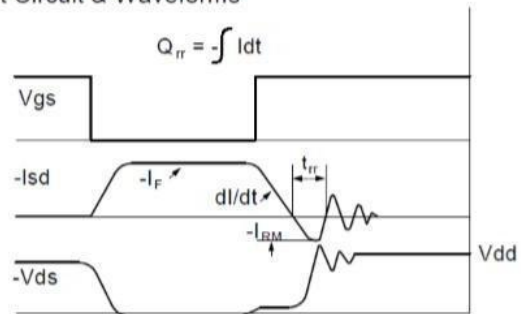
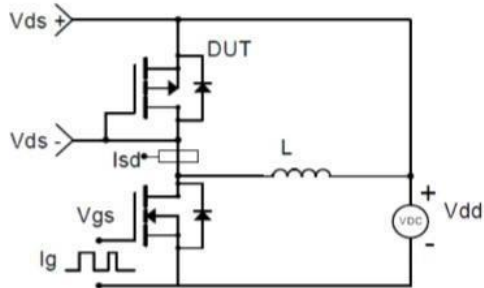



TO-252-2L(TO-252-2(DPAK)) Package Information

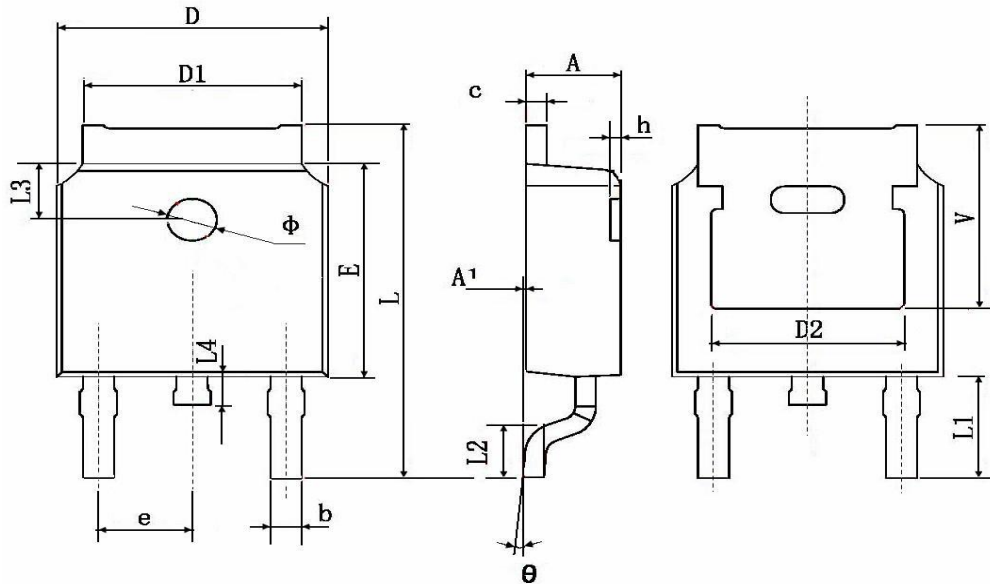

Symbol	Dimensions In Millimeters		Dimensions In Inches	
	Min.	Max.	Min.	Max.
A	2.200	2.400	0.087	0.094
A1	0.000	0.127	0.000	0.005
b	0.660	0.860	0.026	0.034
c	0.460	0.580	0.018	0.023
D	6.500	6.700	0.256	0.264
D1	5.100	5.460	0.201	0.215
D2	4.830 TYP.		0.190 TYP.	
E	6.000	6.200	0.236	0.244
e	2.186	2.386	0.086	0.094
L	9.800	10.400	0.386	0.409
L1	2.900 TYP.		0.114 TYP.	
L2	1.400	1.700	0.055	0.067
L3	1.600 TYP.		0.063 TYP.	
L4	0.600	1.000	0.024	0.039
φ	1.100	1.300	0.043	0.051
θ	0°	8°	0°	8°
h	0.000	0.300	0.000	0.012
V	5.350 TYP.		0.211 TYP.	



Attention

- Any and all HUA XUAN YANG ELECTRONICS products described or contained herein do not have specifications that can handle applications that require extremely high levels of reliability, such as life-support systems, aircraft's control systems, or other applications whose failure can be reasonably expected to result in serious physical and/or material damage. Consult with your HUA XUAN YANG ELECTRONICS representative nearest you before using any HUA XUAN YANG ELECTRONICS products described or contained herein in such applications.
- HUA XUAN YANG ELECTRONICS assumes no responsibility for equipment failures that result from using products at values that exceed, even momentarily, rated values (such as maximum ratings, operating condition ranges, or other parameters) listed in products specifications of any and all HUA XUAN YANG ELECTRONICS products described or contained herein.
- Specifications of any and all HUA XUAN YANG ELECTRONICS products described or contained herein stipulate the performance, characteristics, and functions of the described products in the independent state, and are not guarantees of the performance, characteristics, and functions of the described products as mounted in the customer's products or equipment. To verify symptoms and states that cannot be evaluated in an independent device, the customer should always evaluate and test devices mounted in the customer's products or equipment.
- HUA XUAN YANG ELECTRONICS CO.,LTD. strives to supply high-quality high-reliability products. However, any and all semiconductor products fail with some probability. It is possible that these probabilistic failures could give rise to accidents or events that could endanger human lives, that could give rise to smoke or fire, or that could cause damage to other property. When designing equipment, adopt safety measures so that these kinds of accidents or events cannot occur. Such measures include but are not limited to protective circuits and error prevention circuits for safe design, redundant design, and structural design.
- In the event that any or all HUA XUAN YANG ELECTRONICS products(including technical data, services) described or contained herein are controlled under any of applicable local export control laws and regulations, such products must not be exported without obtaining the export license from the authorities concerned in accordance with the above law.
- No part of this publication may be reproduced or transmitted in any form or by any means, electronic or mechanical, including photocopying and recording, or any information storage or retrieval system, or otherwise, without the prior written permission of HUA XUAN YANG ELECTRONICS CO.,LTD.
- Information (including circuit diagrams and circuit parameters) herein is for example only ; it is not guaranteed for volume production. HUA XUAN YANG ELECTRONICS believes information herein is accurate and reliable, but no guarantees are made or implied regarding its use or any infringements of intellectual property rights or other rights of third parties.
- Any and all information described or contained herein are subject to change without notice due to product/technology improvement, etc. When designing equipment, refer to the "Delivery Specification" for the HUA XUAN YANG ELECTRONICS product that you intend to use.