



Description

The AON7401-HXY uses advanced trench technology excellent $R_{DS(ON)}$, low gate charge and operation with gate voltages as low as 4.5V. This device is suitable for use as a load switch or in PWM applications.

General Features

$V_{DS} = -30V, I_D = -50A$

$R_{DS(ON)} < 15m\Omega @ V_{GS} = -10V$

$R_{DS(ON)} < 25m\Omega @ V_{GS} = -4.5V$

High Power and current handling capability

Lead free product is acquired

Surface mount package

Application

PWM applications

Load switch

Power management

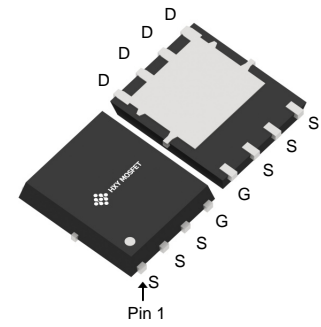

DFN5X6-8L

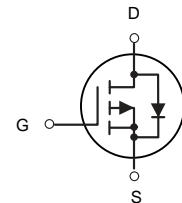

P-Channel MOSFET

Ordering Information

Product ID	Pack	Brand	Qty(PCS)
AON7401-HXY	DFN5X6-8L	HXY MOSFET	5000

Absolute Maximum Ratings ($T_A = 25^\circ C$ unless otherwise noted)

Symbol	Parameter	Limit	Unit
V _{DS}	Drain-Source Voltage	-30	V
V _{GS}	Gate-Source Voltage	±20	V
I _D	Drain Current-Continuous ($T_C = 25^\circ C$)	-50	A
	Drain Current-Continuous ($T_C = 100^\circ C$)	-24	
IDM	Drain Current-Pulsed (Note 1)	-80	A
P _D	Maximum Power Dissipation ($T_C = 25^\circ C$)	3	W
	Maximum Power Dissipation ($T_C = 100^\circ C$)	1.3	
EAS	Single pulse avalanche energy (Note 5)	231	mJ
T _J , T _{STG}	Operating Junction and Storage Temperature Range	-55 To 150	°C
R _{θJA}	Thermal Resistance, Junction-to-Ambient (Note 2)	41.67	°C/W



Electrical Characteristics ($T_A=25^\circ\text{C}$ unless otherwise noted)

Parameter	Symbol	Condition	Min	Typ	Max	Unit
Drain-Source Breakdown Voltage	BV_{DSS}	$V_{GS}=0V, I_D=-250\mu A$	-30	-33	-	V
Zero Gate Voltage Drain Current	I_{DSS}	$V_{DS}=-30V, V_{GS}=0V$	-	-	-1	μA
Gate-Body Leakage Current	I_{GSS}	$V_{GS}=\pm 20V, V_{DS}=0V$	-	-	± 100	nA
Gate Threshold Voltage	$V_{GS(th)}$	$V_{DS}=V_{GS}, I_D=-250\mu A$	-1	-1.5	-3	V
Drain-Source On-State Resistance	$R_{DS(ON)}$	$V_{GS}=-10V, I_D=-10A$	-	9	15	m Ω
		$V_{GS}=-4.5V, I_D=-7A$	-	18	25	m Ω
Forward Transconductance	g_{FS}	$V_{DS}=-10V, I_D=-10A$	-	20	-	S
Input Capacitance	C_{iss}	$V_{DS}=-15V, V_{GS}=0V,$ $F=1.0MHz$	-	1750	-	PF
Output Capacitance	C_{oss}		-	215	-	PF
Reverse Transfer Capacitance	C_{rSS}		-	180	-	PF
Turn-on Delay Time	$t_{d(on)}$	$V_{DD}=-15V, I_D=-10A,$ $V_{GS}=-10V, R_{GEN}=1\Omega$	-	9	-	nS
Turn-on Rise Time	t_r		-	8	-	nS
Turn-Off Delay Time	$t_{d(off)}$		-	28	-	nS
Turn-Off Fall Time	t_f		-	10	-	nS
Total Gate Charge	Q_g	$V_{DS}=-15V, I_D=-10A, V_{GS}=-10V$	-	24	-	nC
Gate-Source Charge	Q_{gs}		-	3.5	-	nC
Gate-Drain Charge	Q_{gd}		-	6	-	nC
Diode Forward Current ^(Note 2)	I_S		-	-	-12	A
Diode Forward Voltage ^(Note 3)	V_{SD}	$V_{GS}=0V, I_S=-12A$	-	-	-1.2	V

Notes:

1. Repetitive Rating: Pulse width limited by maximum junction temperature.
2. Surface Mounted on FR4 Board, $t \leq 10$ sec.
3. Pulse Test: Pulse Width $\leq 300\mu s$, Duty Cycle $\leq 2\%$.
4. Guaranteed by design, not subject to production
5. E_{AS} condition: $T_j=25^\circ\text{C}, V_{DD}=-15V, V_G=10V, L=0.5mH, R_g=25\Omega, I_{AS}=-34A$



Typical Electrical and Thermal Characteristics

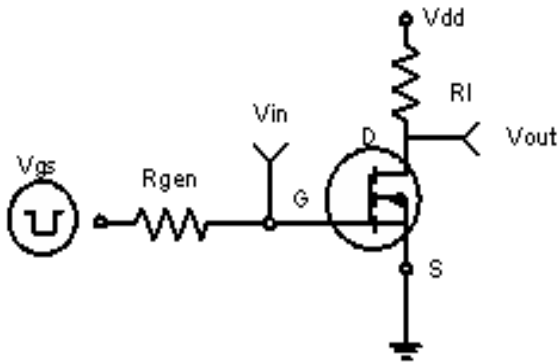

Figure 1: Switching Test Circuit

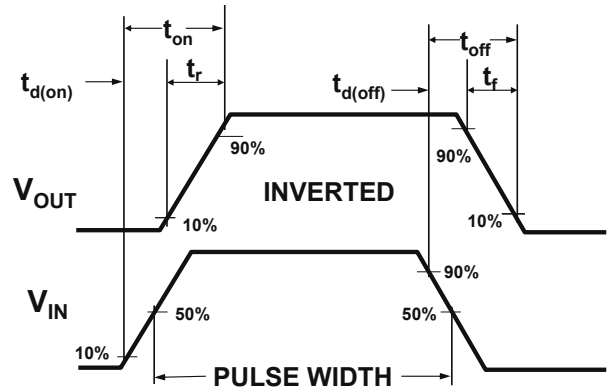
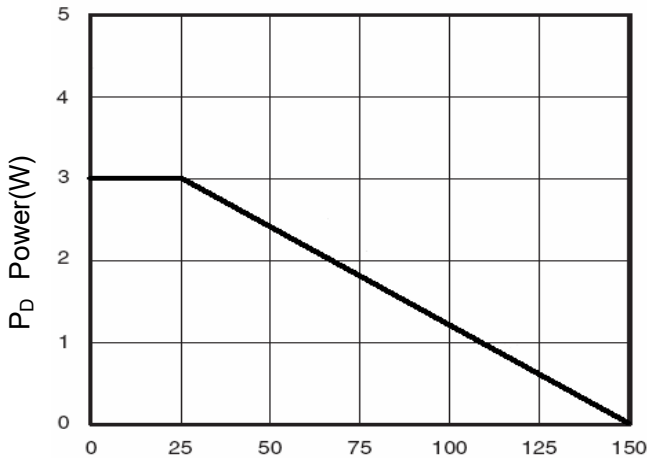
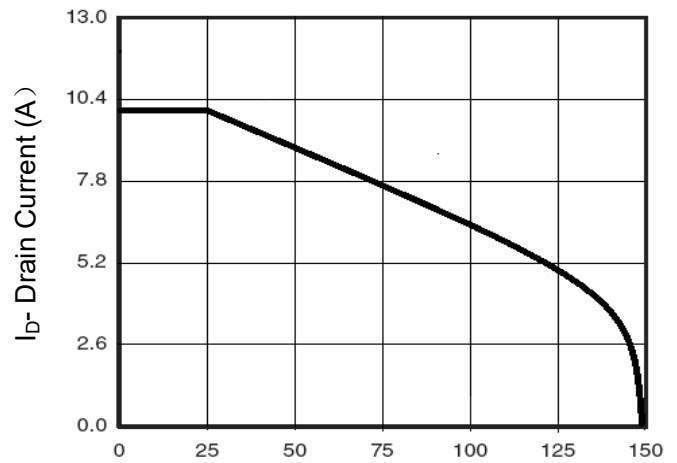

Figure 2: Switching Waveforms



T_J-Junction Temperature(°C)
Figure 3 Power Dissipation



T_J-Junction Temperature(°C)
Figure 4 Drain Current

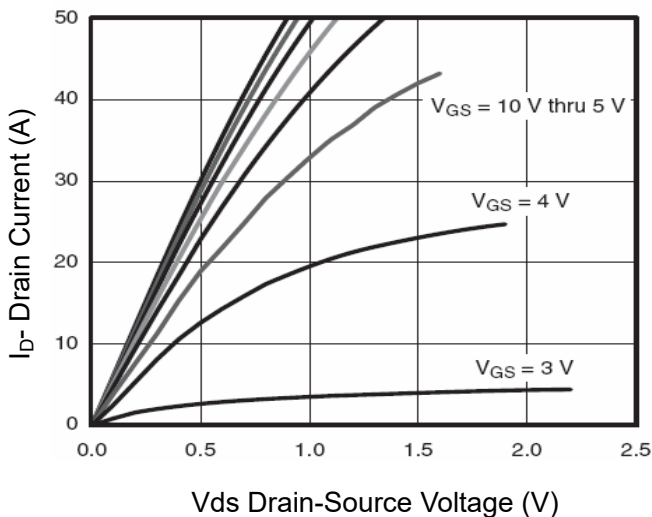

V_{ds} Drain-Source Voltage (V)
Figure 5 Output Characteristics

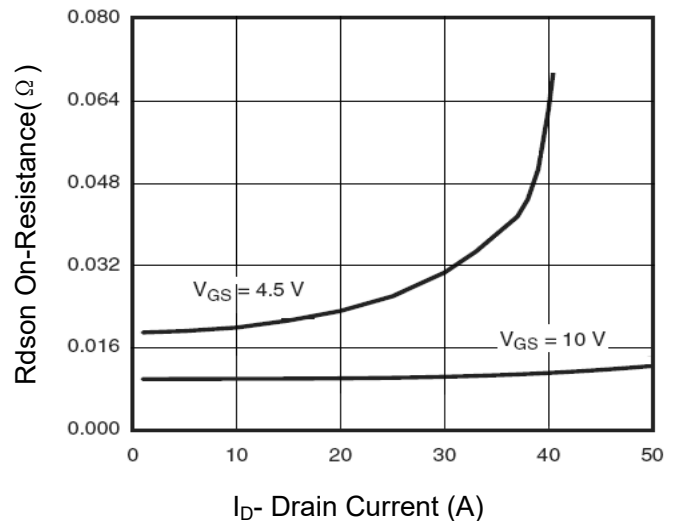

ID- Drain Current (A)
Figure 6 Drain-Source On-Resistance



Figure 5 Output Characteristics

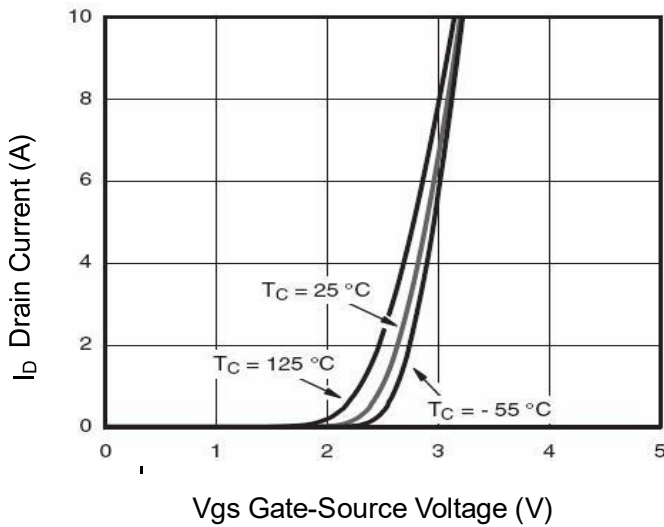

Figure 7 Transfer Characteristics

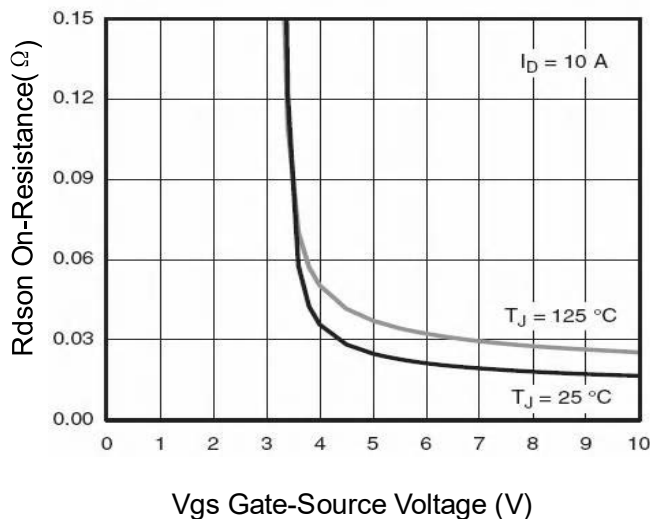

Figure 9 Rds(on) vs Vgs

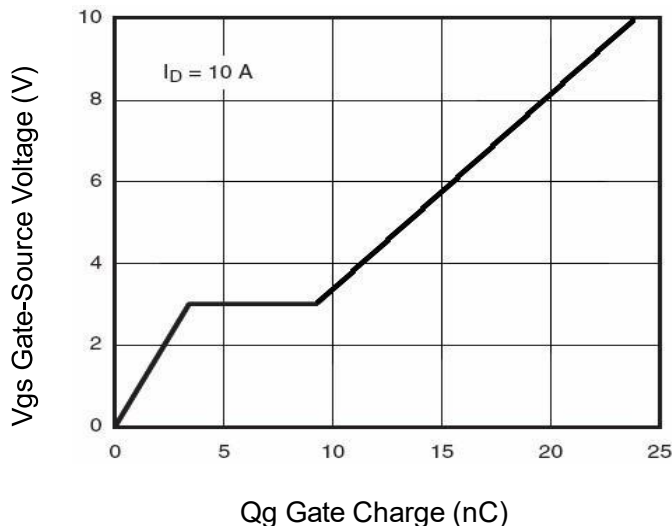

Figure 11 Gate Charge

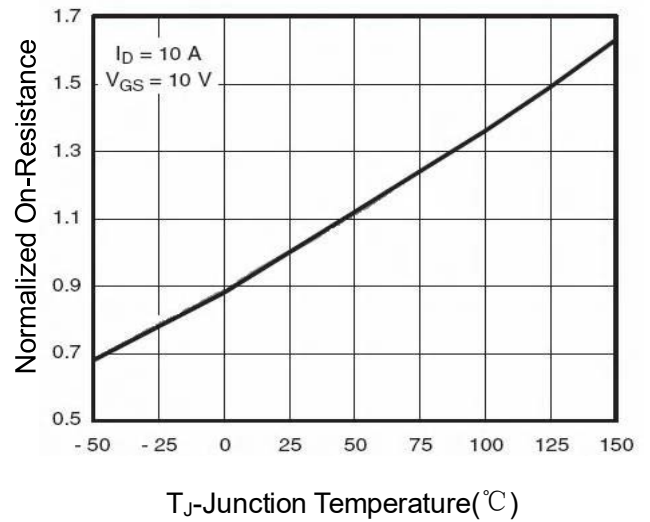

Figure 8 Drain-Source On-Resistance

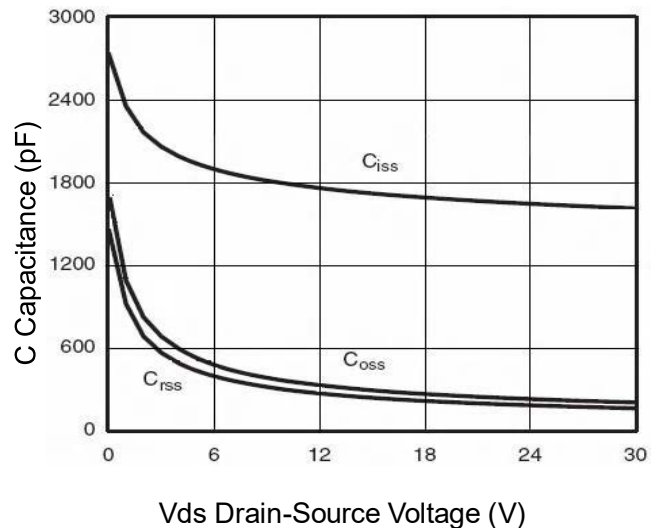

Figure 10 Capacitance vs Vds

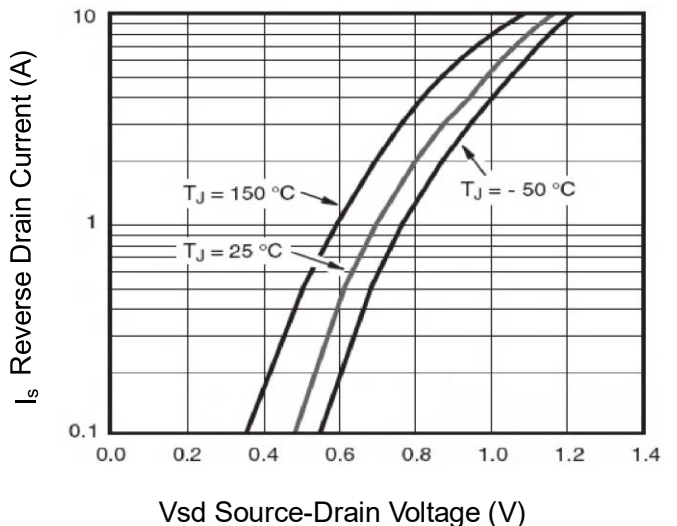

Figure 12 Source- Drain Diode Forward

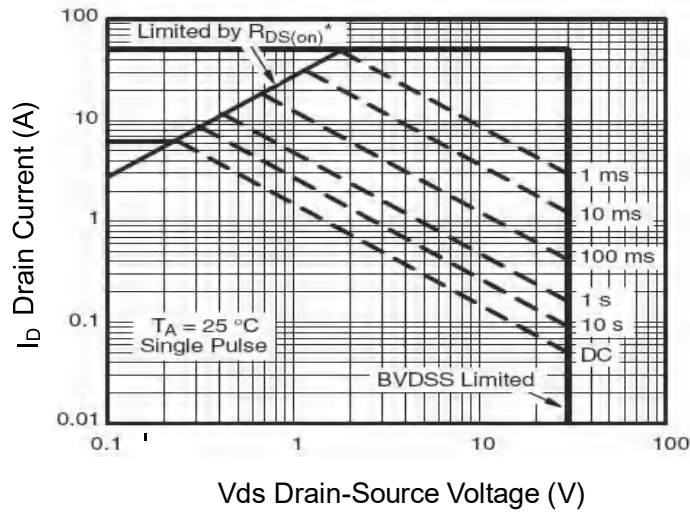

Figure 13 Safe Operation Area

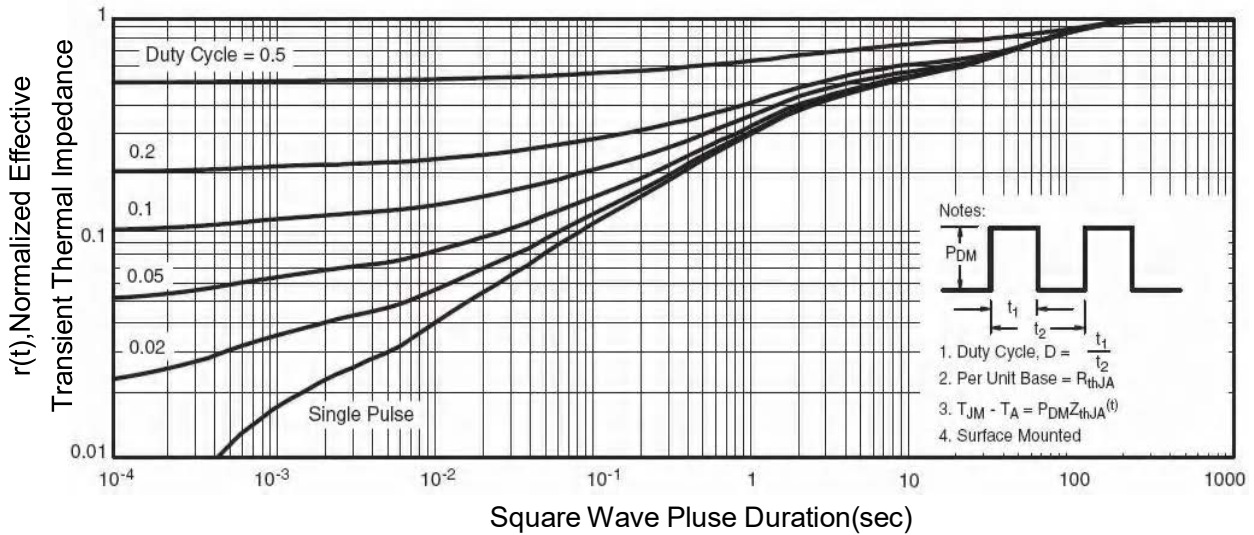
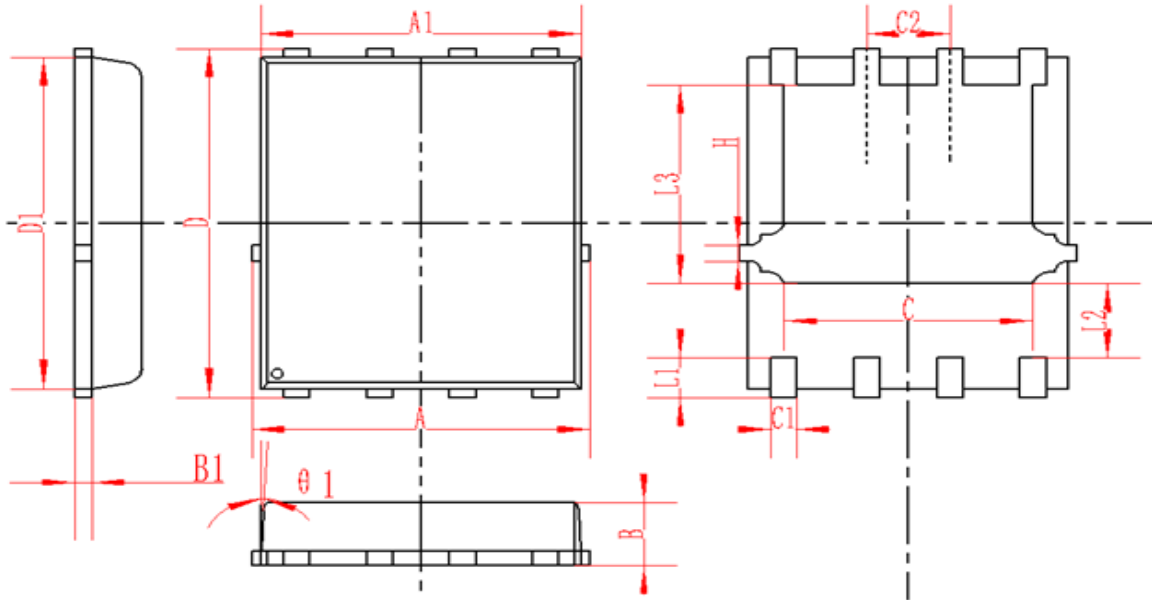

Figure 14 Normalized Maximum Transient Thermal Impedance



DFN5X6-8L Package Information



SYMBOL	MM			INCH		
	MIN	NOM	MAX	MIN	NOM	MAX
A	4.95	5	5.05	0.195	0.197	0.199
A1	4.82	4.9	4.98	0.190	0.193	0.196
D	5.98	6	6.02	0.235	0.236	0.237
D1	5.67	5.75	5.83	0.223	0.226	0.230
B	0.9	0.95	1	0.035	0.037	0.039
B1	0.254REF			0.010REF		
C	3.95	4	4.05	0.156	0.157	0.159
C1	0.35	0.4	0.45	0.014	0.016	0.018
C2	1.27TYP			0.5TYP		
θ1	8°	10°	12°	8°	10°	12°
L1	0.63	0.64	0.65	0.025	0.025	0.026
L2	1.2	1.3	1.4	0.047	0.051	0.055
L3	3.415	3.42	3.425	0.134	0.135	0.135
H	0.24	0.25	0.26	0.009	0.010	0.010



Attention

- Any and all HUA XUAN YANG ELECTRONICS products described or contained herein do not have specifications that can handle applications that require extremely high levels of reliability, such as life-support systems, aircraft's control systems, or other applications whose failure can be reasonably expected to result in serious physical and/or material damage. Consult with your HUA XUAN YANG ELECTRONICS representative nearest you before using any HUA XUAN YANG ELECTRONICS products described or contained herein in such applications.
- HUA XUAN YANG ELECTRONICS assumes no responsibility for equipment failures that result from using products at values that exceed, even momentarily, rated values (such as maximum ratings, operating condition ranges, or other parameters) listed in products specifications of any and all HUA XUAN YANG ELECTRONICS products described or contained herein.
- Specifications of any and all HUA XUAN YANG ELECTRONICS products described or contained herein stipulate the performance, characteristics, and functions of the described products in the independent state, and are not guarantees of the performance, characteristics, and functions of the described products as mounted in the customer's products or equipment. To verify symptoms and states that cannot be evaluated in an independent device, the customer should always evaluate and test devices mounted in the customer's products or equipment.
- HUA XUAN YANG ELECTRONICS CO.,LTD. strives to supply high-quality high-reliability products. However, any and all semiconductor products fail with some probability. It is possible that these probabilistic failures could give rise to accidents or events that could endanger human lives, that could give rise to smoke or fire, or that could cause damage to other property. When designing equipment, adopt safety measures so that these kinds of accidents or events cannot occur. Such measures include but are not limited to protective circuits and error prevention circuits for safe design, redundant design, and structural design.
- In the event that any or all HUA XUAN YANG ELECTRONICS products(including technical data, services) described or contained herein are controlled under any of applicable local export control laws and regulations, such products must not be exported without obtaining the export license from the authorities concerned in accordance with the above law.
- No part of this publication may be reproduced or transmitted in any form or by any means, electronic or mechanical, including photocopying and recording, or any information storage or retrieval system, or otherwise, without the prior written permission of HUA XUAN YANG ELECTRONICS CO.,LTD.
- Information (including circuit diagrams and circuit parameters) herein is for example only ; it is not guaranteed for volume production. HUA XUAN YANG ELECTRONICS believes information herein is accurate and reliable, but no guarantees are made or implied regarding its use or any infringements of intellectual property rights or other rights of third parties.
- Any and all information described or contained herein are subject to change without notice due to product/technology improvement, etc. When designing equipment, refer to the "Delivery Specification" for the HUA XUAN YANG ELECTRONICS product that you intend to use.