

# 承认书

## Approved Sheet

客户名称：	
客户物料名称：	
客户物料编码：	
文件编号：	
拓展品名：	TZ-C0602-WH/D-BA10KF-YA1105NA/0000
拓展料号：	F.0602.00041

客户

检测员：
审核：
批准：
盖章：

拓展

检测员：
审核：
批准：
日期：

广东拓展光电子有限公司

BRIGHTWAY Optoelectronics Co., Ltd.

**TZ-C0602-WH/D-BA10KF-YA1105NA/0000**

The SMD LED is much smaller than lead frame type components, thus enable smaller board size, higher packing density, reduced storage space and finally smaller equipment to be obtained. Besides, lightweight makes them ideal for miniature applications. etc.

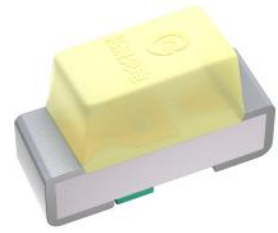
**Applications/产品应用**

Backlight	背光
Lighting	照明
Indicator Light	发光指示灯
Others	其它

**Features/特性**

Size(mm):1.6*0.6*1.0	尺寸 (毫米) : 1.6*0.6*1.0
Color : White	发光颜色 : 冷 白
Viewing angle: 120°	发光角度 : 120°
ESD protection up to 1.5KV	抗静电 : 1.5KV
High reliability	高可靠性
RoHS compliant	通过RoHS认证

## Absolute maximum ratings(Ta=25°C)/最大额定值

Parameters/参数	Symbol/符号	Value/数值	Unit/单位
Power dissipated 功率消耗	P <sub>D</sub>	90	mW
forward current 正向电流	I <sub>F</sub>	20	mA
Operating temperature 工作温度	T <sub>OPR</sub>	-40~+60	°C
Storage temperature 储存温度	T <sub>STG</sub>	-40~+85	°C
Soldering temperature 焊接温度	Reflow soldering 260°C for 10sec		

Proper current derating must be observed to maintain junction temperature below the Maximum.

## Electro optical characteristics(Ta=25°C)/光电特性

Parameters 参数	Test condition 测试条件	Symbol 符号	颜色 Color	Min 最小	Typ 典型	Max 最大	Unit 单位
Forward voltage 正向电压	5mA	V <sub>F</sub>	W	2.7	--	3.0	V
Luminous intensity 发光强度	5mA	I <sub>V</sub>	W	151	--	256	mcd
Color temperature 色温	5mA	TC	W	8500	--	20000	K
Chromatic coordinates 色温	5mA	X	W	--	X:0.2782	--	
		Y			Y:0.2814		
View Angle 发光角度	5mA	2θ <sub>1/2</sub>	W	--	120	--	deg
Electrostatic discharge 抗静电	HBM	ESD	W	--	--	1500	V
Reverse Current 反向漏电流	VR=5V	I <sub>R</sub>	W	--	--	3	uA

Note: Measurement tolerance : V<sub>f</sub> ±0.1V Luminous Intensity : ±10% Wavelength(x,y) : ±1nm/ ±0.01

Ranks(sorting current=5mA, Ta=25°C)/档位

Item 项目	Color 颜色	Min 最小值	Max 最大值	Unit 单位
IV亮度	W	151	197	mcd
		197	256	

Item 项目	Color 颜色	Min 最小值	Max 最大值	Unit 单位
VF电压	W	2.7	2.8	V
		2.8	2.9	
		2.9	3.0	

# TZ-C0602-WH/D-BA10KF-YA1105NA/0000

Color zone bin(TA=25°C, IF=5mA)

色区 BIN (温度=25°C, 测试电流=5mA)

色区代码	X1	Y1	X2	Y2	X3	Y3	X4	Y4
A2	0.2435	0.2215	0.2487	0.2316	0.2559	0.2279	0.2508	0.2179
A3	0.2487	0.2316	0.2538	0.2417	0.2611	0.2381	0.2559	0.2279
A4	0.2538	0.2417	0.259	0.2517	0.2663	0.2481	0.2611	0.2381
A5	0.259	0.2517	0.2642	0.2618	0.2714	0.2581	0.2663	0.2481
A6	0.2642	0.2618	0.2693	0.2718	0.2765	0.2682	0.2714	0.2581
A7	0.2693	0.2718	0.2744	0.2819	0.2816	0.2783	0.2765	0.2682
A8	0.2744	0.2819	0.2795	0.2919	0.2867	0.2883	0.2816	0.2783
A9	0.2795	0.2919	0.2846	0.302	0.2918	0.2984	0.2867	0.2883
A10	0.2846	0.302	0.2898	0.312	0.2970	0.3084	0.2918	0.2984

Color block diagram(TA=25°C, IF=5mA)

色区块 (温度=25°C, 测试电流=5mA)

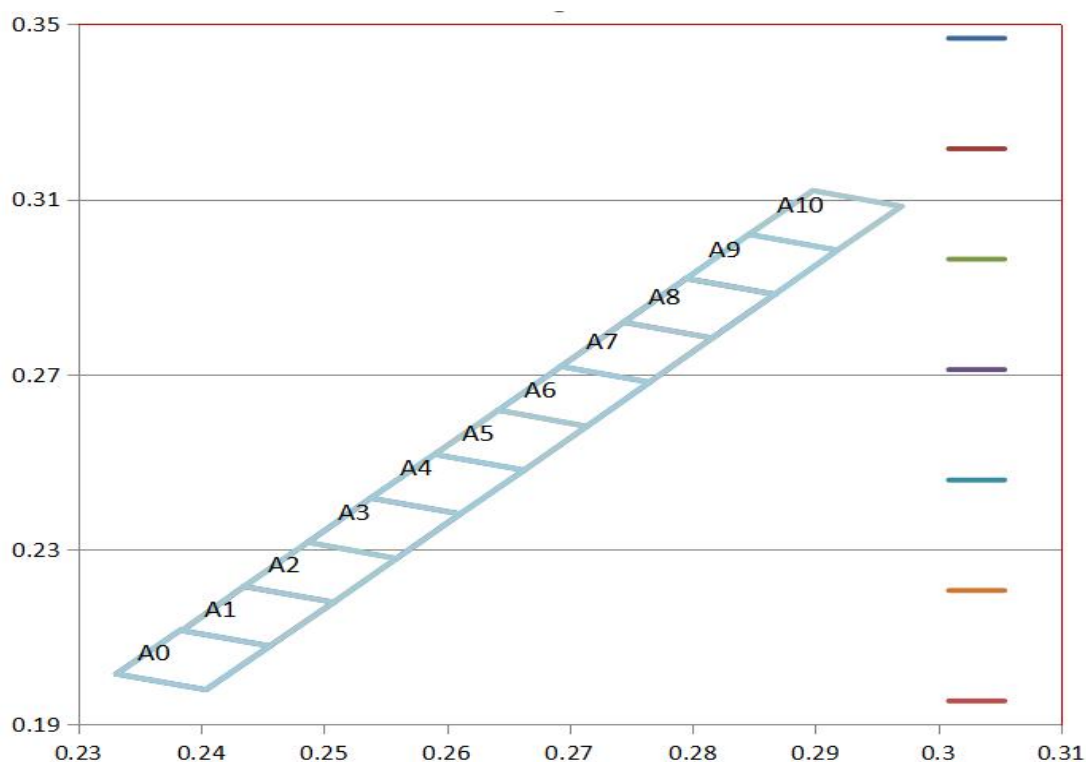

Typical electrical optical characteristic curves/典型光电特征曲线

Relative Spectral Emission  
 $\Phi_{rel} = f(\lambda)$ ;  $I_F = 5 \text{ mA}$ ;  $T_J = 25 \text{ }^\circ\text{C}$

Forward current Vs Forward Voltage  
 $I_F = f(V_F)$ ;  $T_J = 25 \text{ }^\circ\text{C}$

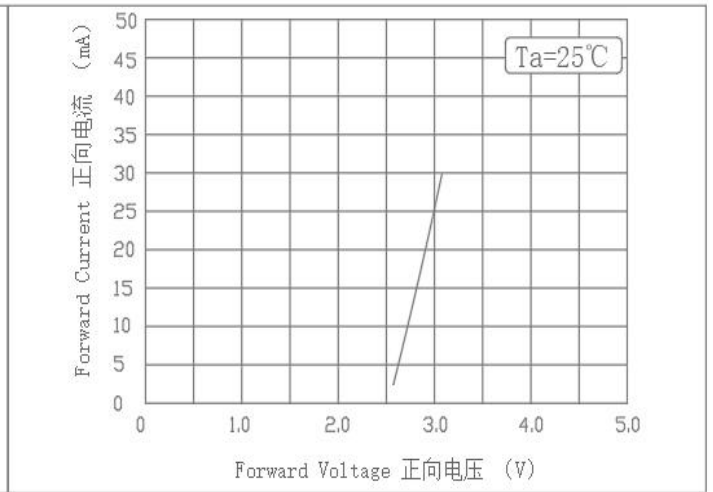
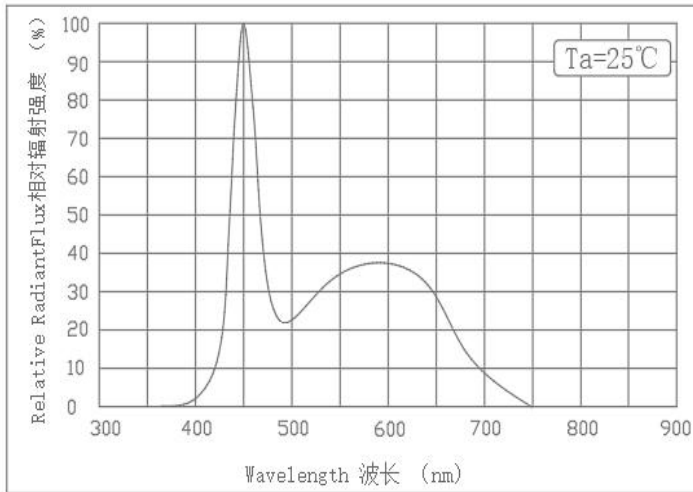

Max. Permissible Forward Current  
 $I_F = f(T)$

Forward Voltage  
 $\Delta V_F = V_F - V_F(25^\circ\text{C}) = f(T_J)$ ;  $I_F = 5 \text{ mA}$

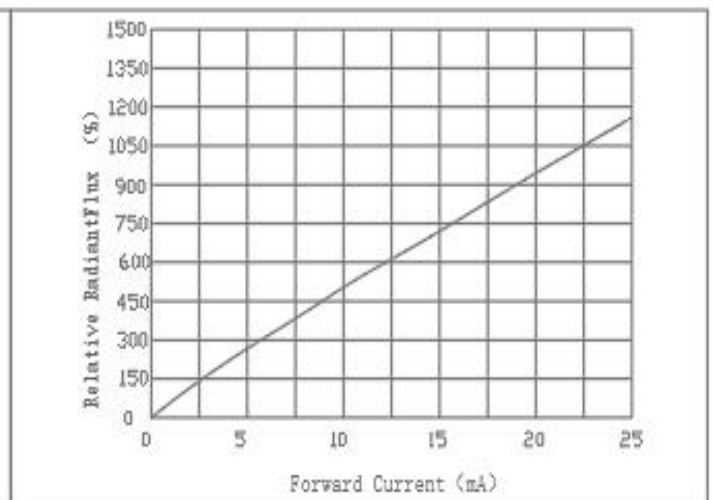
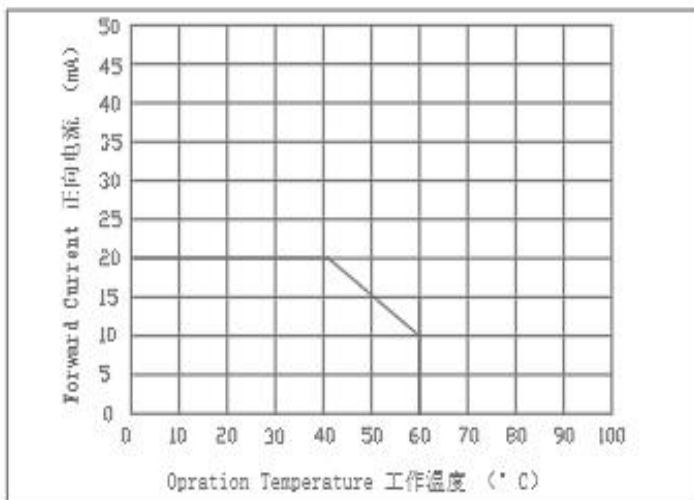

Radiation Characteristics

$I_{rel} = f(\varphi)$ ;  $T_J = 85\text{ }^\circ\text{C}$

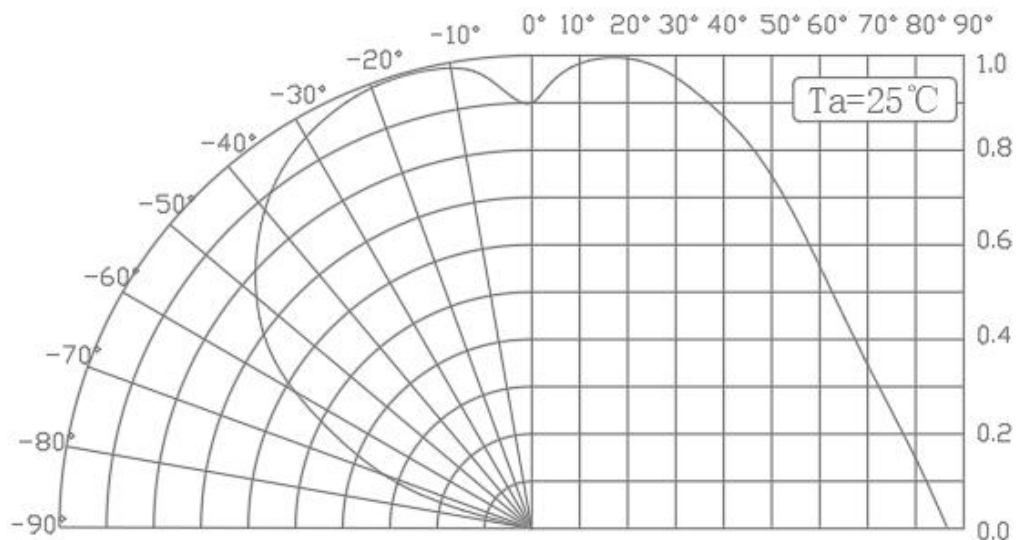

View angle VS. Radiation 半功率角VS. 发光强度曲线

Notes:

1.  $2\theta_{1/2}$  is the off axis angle from lamp centerline where the luminous intensity is 1/2 of the peak value.
2. View angle tolerance is  $\pm 5^\circ$  .

Package dimensions/产品外观尺寸

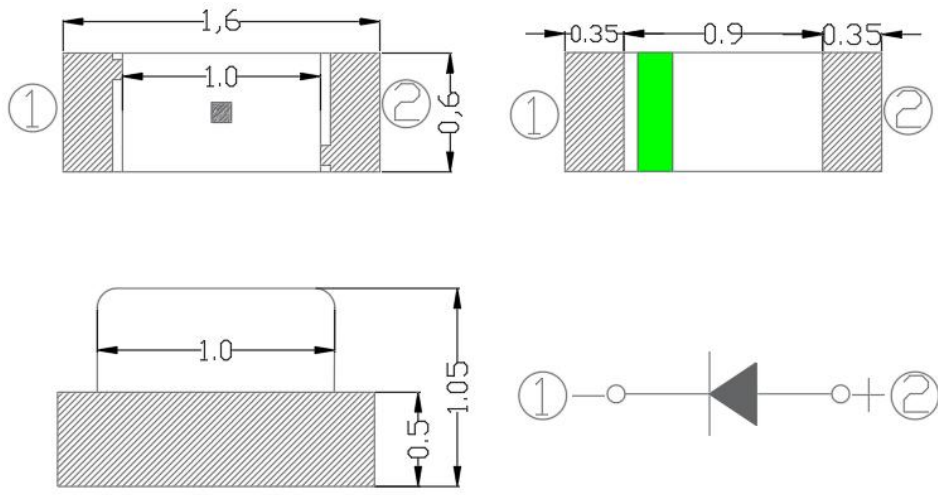

For reflow soldering

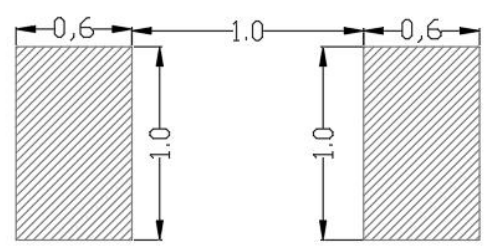

- (1) All dimensions are in millimeters ;  
单位：毫米
- (2) Tolerances are  $\pm 0.2\text{mm}$  unless otherwise noted.  
未标注公差处公差为 $\pm 0.2\text{mm}$ 。

Packaging specifications/包装规格

Product Labeling/产品标签

Label Explanation/标签解释

Name: Part Number  
 LOT No: Lot Number  
 Prd No: LProduct Code  
 IF(mA): Operation Forward current  
 VF(V): Forward voltage Bin  
 Po: Radiation Power  
 WP: Wavelength Bin  
 BINCODE : Bin Code  
 Q' TY (pcs): Package Quantity  
 Date : Packaging Date

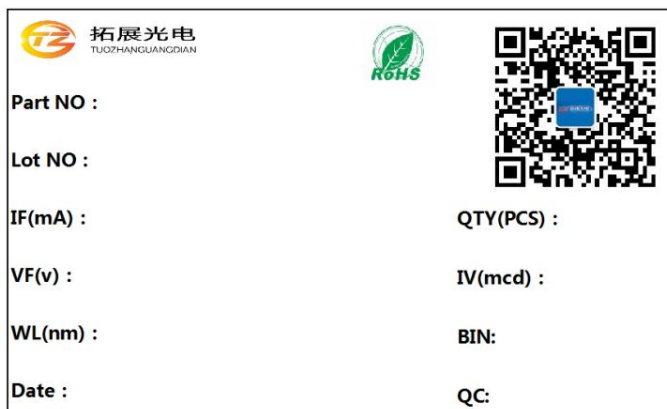

Emitter Reel Packaging/卷盘包装

Reel Dimensions/卷盘尺寸

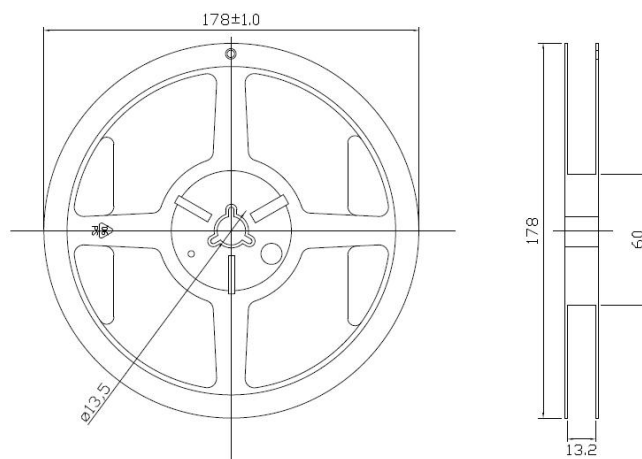

Note/备注 :

1. All dimensions are in millimeters ;

单位 : 毫米

### Tape On Reel Package/载带包装

Carrier Tape Dimensions as the following/载带尺寸

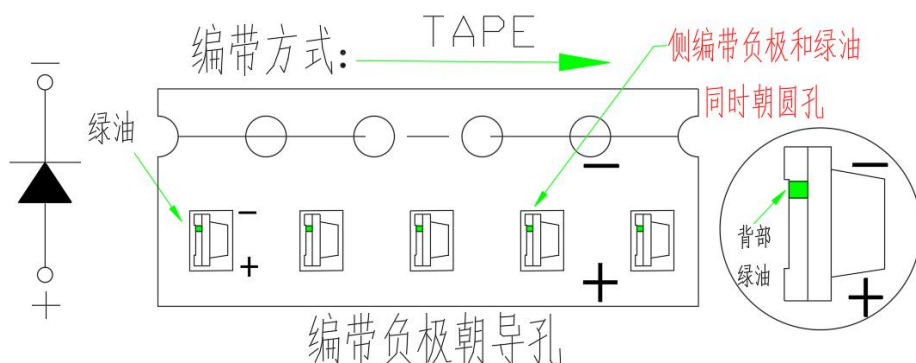

Note/备注：

- (1) The cathode is oriented towards the tape sprocket hole in accordance with data sheet specifications.  
根据图表显示，侧编带负极朝向载带孔。
- (2) MPQ:4000pcs per reel.  
4000颗/每盘。
- (3) 100 empty in front of the tape sprocket，100empty in the end of the tape sprocket.  
载带前空100颗，后空100颗。

### Moisture Resistant Packaging/防潮包装

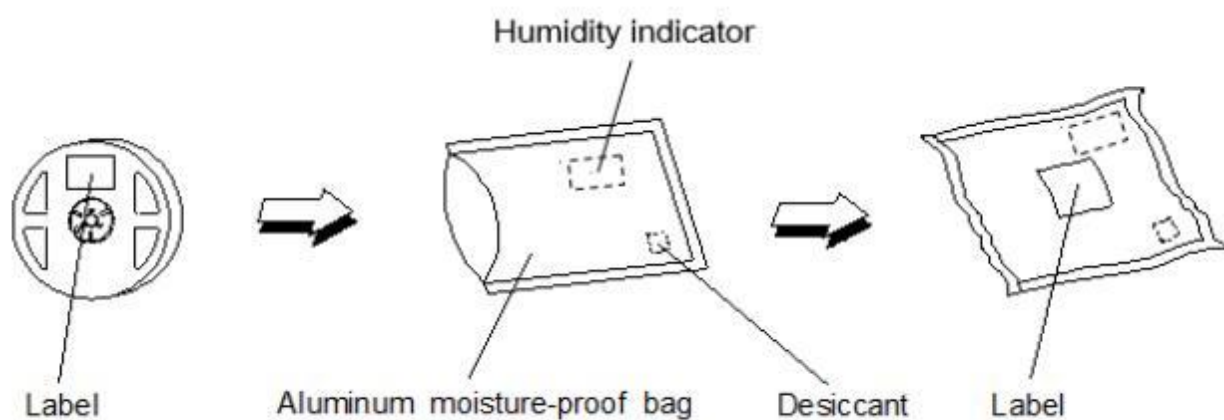

Soldering Characteristics/焊接工艺

Reflow Soldering Profile/回流曲线

Product complies to MSL Level 2 acc. to JEDEC J-STD-020E

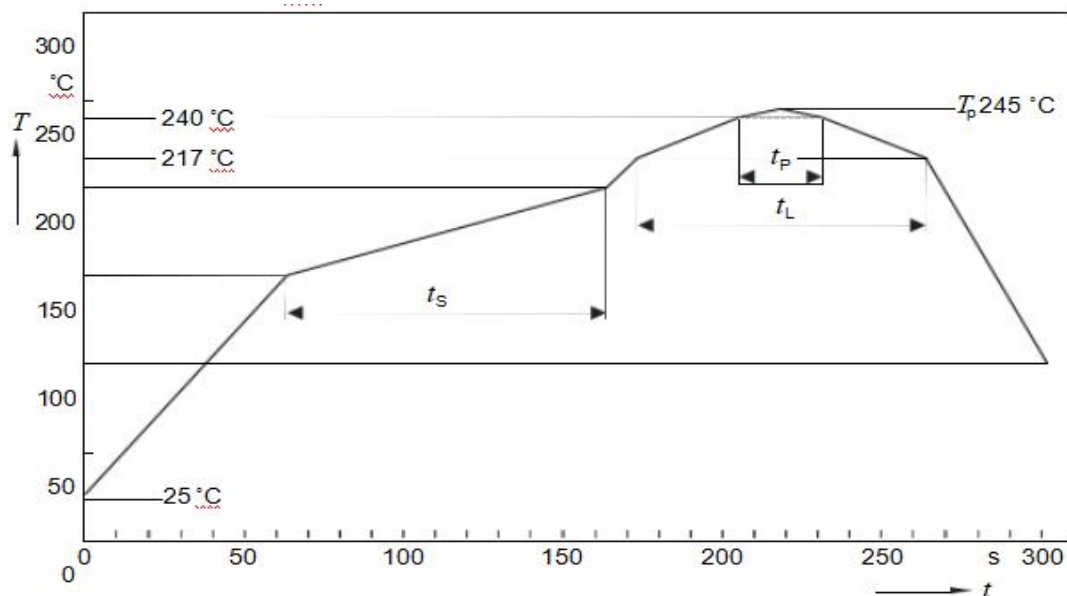

Profile Feature	Pb-Free Assembly	Unit Einheit
Average Ramp-up Rate 25 °C to 150 °C	2-3	°C /sec
Preheat Temperature Min.	150	sec
Preheat Temperature Max.	200	sec
Preheat Time	60- 120	sec
Time Maintained Above Temperature	217	°C
Time Maintained Above Time	60-90	sec
Peak Temperature (max.)	260	°C

- c. Reflow soldering should not be done more than twice.
- d. In soldering process, stress on the LEDs during heating should be avoided.
- e. After soldering, do not bend the circuit board.

## Cautions/注意事项

### 1. Moisture-Proof Package/防潮包装

1.1 When moisture is absorbed into the LED package it may vaporize and expand products during soldering. There is a possibility that this may cause exfoliation of the contacts and damage to the optical characteristics of the LEDs. For this reason, the moisture-proof package is used to keep moisture to a minimum in the package.

当水分被吸收到 LED 包装中时，它可能会在焊接过程中蒸发并膨胀产品。这可能会导致触点脱落并损坏 LED 的光学特性。因此，防潮包装需要将包装中的水分保持在最低限度。

### 2. Current limiting/限流

2.1 A resistor should be used to limit current spikes that can be caused by voltage fluctuations. Otherwise damage could be occur.

应使用电阻器限制电压波动引起的电流峰值。否则可能会发生损坏。

### 3. Iron Soldering/烙铁焊接

3.1 Hand soldering is not recommended for regular production. These guidelines are for rework only.

常规生产不建议手工焊接。此方法仅适用于返工。

3.2 The recommended condition is less than 5s at 260°C.

建议的条件是在 260°C 时小于 5s。

3.3 The time must be shorter for higher temperatures. (+10°C → -1sec)

对于较高的温度，时间必须更短。( +10°C → -1 秒 )

3.4 The power dissipation of the soldering iron should be lower than 25W and the surface temperature of the device should be controlled at under 300°C.

烙铁的功耗应低于 25W，器件表面温度应控制在 300°C 以下。

### 4. Storage Conditions/储存条件

4.1 Before opening the package : The LEDs should be kept at 30°C or less and 90%RH or less. The LEDs should be used within a year. When storing the LEDs, moisture-proof packaging with moisture-absorbent material is recommended.

打开包装前：LED 应保持在 30°C 或以下，相对湿度为 90% 或以下。LED 应在一年内使用。储存 LED 时，建议使用吸湿材进行防潮包装。

4.2 After opening the package: The LEDs should be kept at 30°C or less and 60%RH or less. The LEDs should be soldered within 168 hours (7 days) after opening the package. If unused LEDs remain, they should be stored in moisture-proof packages, such as sealed containers with packages of moisture-absorbent material. It is also recommended to return the LEDs to the original moisture-proof bag and to reseal the moisture-proof bag again.

打开包装后：LED 应保持在 30°C 或以下，相对湿度为 60% 或以下。LED 应在打开包装后 168 小时 ( 7 天 ) 内焊接。如果仍有未使用的 LED 灯珠，则应将其储存在防潮包装中，例如带有吸湿材料包装的密封

容器中。也建议将 LED 灯珠放回原来的防潮袋，并再次重新密封防潮袋。

4.3 If the moisture-absorbent material has faded away or the LEDs have exceeded the recommended storage time, baking treatment should be performed using the following conditions. Baking treatment: more than 24 hours at  $65\pm 5^{\circ}\text{C}$

如果吸湿材料褪色或 LED 超过建议的存储时间，则应使用以下条件进行除湿处理。除湿处理：在  $65\pm 5^{\circ}\text{C}$  下烘烤超过 24 小时。

4.4 **BRIGHTWAY** LED electrode sections are comprised of a silver-plated copper alloy. The silver surface may be affected by environments which contain corrosive gases and so on. Please avoid condition which may cause difficulty environments during soldering operations. It is recommended that the user uses the LEDs as soon as possible.

拓展 LED 灯珠电极部分由镀银铜合金组成。银表面可能受到含有腐蚀性气体等环境的影响。在焊接操作过程中，避免出现可能由环境导致问题的情况。建议用户尽快使用 LED 灯珠。

4.5 Please avoid rapid transitions in ambient temperature, especially in high humidity environments where condensation can occur.

请避免环境温度快速变化，尤其是在可能发生冷凝的高湿度环境中。

### 5. Handling of Silicone LEDs/硅胶 LED 灯珠处理

5.1 Avoid silicone resin parts especially with sharp tools such as tweezers.

避免使用锋利工具，尤其是使用镊子等接触硅胶部分。

5.2 Avoid leaving fingerprints on silicone part.

避免在硅胶零件上留下指纹。

### 6. Usage/用途

6.1 Do not exceed the values given in this specification.

不要超出本规范中给出的使用条件。