

制图 DRAWN	变更内容 DESCRIPTION	日期 DATE	GENERAL TOLERANCE		制图 DRAWING	EMMA	料号 PART NO.	BX-TYPEC-WTM24-CH18	版本 REV.	A
			X.±0.30	X.*±10°	审核 CHECK	EVA	品名 TITLE	USB CF 24P SMT TYPE TOP-MOUNT CH=1.8mm	页次 SHEET	1/1
			.X±0.20	.X*±8°	核准 APPROVAL	JADE	客户料号 CUTM.NO.			
			.XX±0.10	.XX*±5°	单位 UNITS	MM	比例 SCALE	1:1		

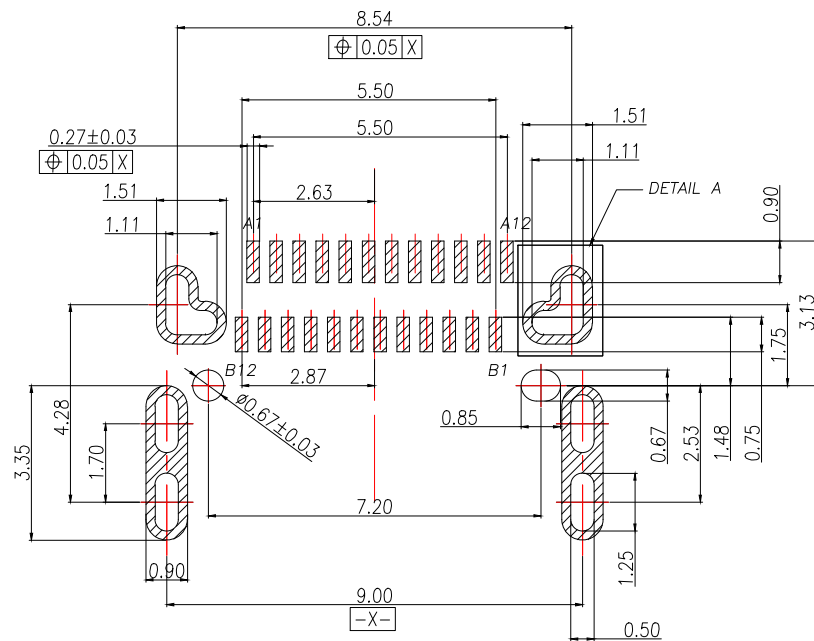

SCALE 2:1

RECOMMENDED PCB LAYOUT(TOP VIEW)
Thickness 1.0mm (TOLERANCE=±0.05mm)

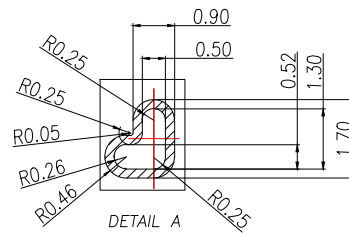



NOTE:

- 1.MATERIAL SPECIFICATION:
 - 1.HOUSING:HIGH TEMPERATURE RESISTANT PLASTIC,UL94 V-0(LCP,BLACK)
 - 2.TERMINAL:COPPER ALLOY(C18150)
 - 3.MID PLATE: STAINLESS STEEL(SUS301)
 - 4.OUT SHELL: STAINLESS STEEL(SUS304)
 - 5.INNER SHELL: STAINLESS STEEL(SUS304)
- 2.PLATING SPECIFICATION:
 - 2-1.CONTACTS:
 - Ni 50u" MIN. UNDER PLATED OVER ALL.
 - Au 3u" PLATED ON CONTACT AREA.
 - Au 1u" PLATED ON SOLDER AREA.
 - 2-2.OUT SHELL&INNER SHELL:
 - Ni 30u" MIN. UNDER PLATED OVER ALL.
 - 2-3.MID PLATE:
 - Ni 30u" MIN. UNDER PLATED OVER ALL.
- 3.MECHANICAL PERFORMANCE,
 - 3-1.INSERTION FORCE: 0.5~2.0kgf.
 - 3-2.REMOVAL FORCE: 0.8kgf~2.0kgf.(INITIAL)
0.6kgf~2.0kgf.(AFTER DURABILITY TEST)
 - 3-3.DURABILITY: 10000 CYCLES.
- 4.ELECTRICAL PERFORMANCE,
 - 4-1. VOLTAGE RATING: 20V.
CURRENT RATING: 5A.
 - 4-2. LLCR:
 - VBUS & GND PINS AND OTHER PINS: 40mA/PIN MAX.
 - LLCR MAX. CHANGE OF ALL PINS: 10mA.
 - 4-3.INSULATION RESISTANCE: 100MΩ MIN
 - 4-4.DIELECTRIC WITHSTAND VOLTAGE,AC 100V FOR 1 MINUTE.
5. ENVIRONMENTAL PERFORMANCE:
 - OPERATING TEMPERATURE: -55°C~+85°C.
- 6.IR REFLOW:
 - THE PEAK TEMPERATURE ON THE BOARD SHALL BE MAINTAINED FOR 10 SECONDS AT 260°C.

USB TYPE-C PIN ASSIGNMENTS

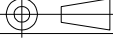
A1	A2	A3	A4	A5	A6	A7	A8	A9	A10	A11	A12
GND	TXp1	TXn1	VBUS	CC1	D+	D-	SBU1	VBUS	RXn2	RXp2	GND
GND	RXp1	RXn1	VBUS	SBU2	D-	D+	CC2	VBUS	TXn2	TXp2	GND
B12	B11	B10	B9	B8	B7	B6	B5	B4	B3	B2	B1

制图 DRAWN	变更内容 DESCRIPTION	日期 DATE	GENERAL TOLERANCE		制图 DRAWING	EMMA		料号 PART NO.	BX-TYPEC-WTM24-CH18		版本 REV.	A
			X.±0.30	X'±10°	审核 CHECK	EVA		品名 TITLE	USB CF 24P SMT TYPE TOP-MOUNT CH=1.8mm		页次 SHEET	1/1
			.X±0.20	.X'±8°	核准 APPROVAL	JADE		客户料号 CUTM.NO.				
			.XX±0.10	.XX'±5°	单位 UNITS	MM	比例 SCALE	1:1				

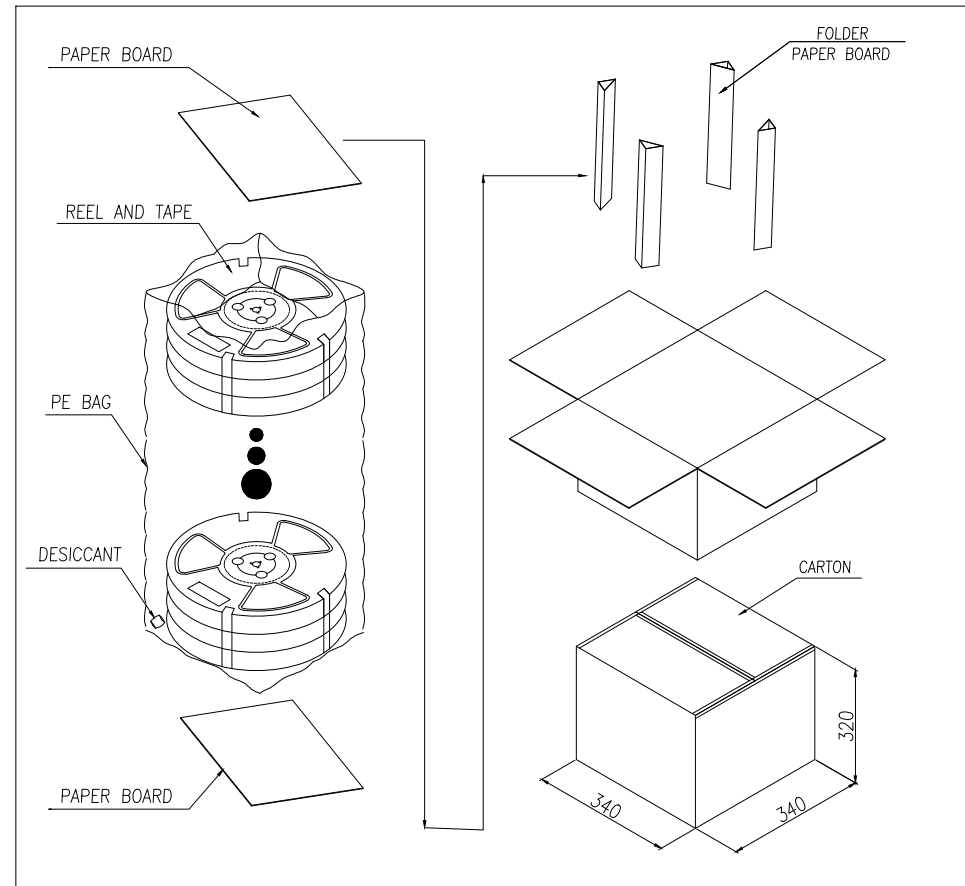
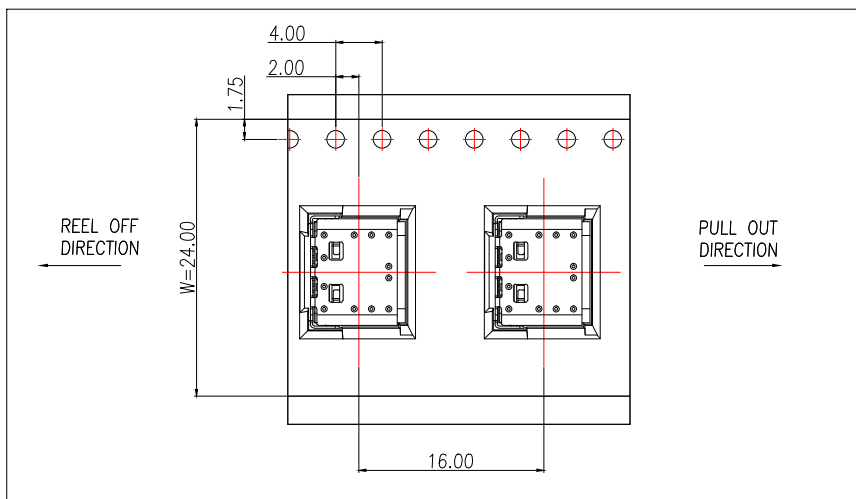
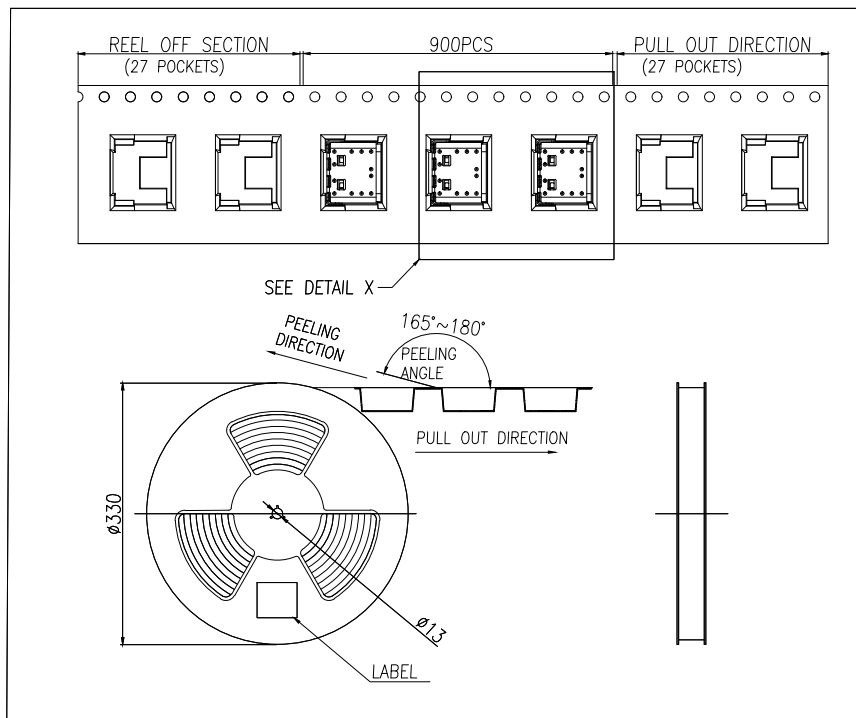

	REEL	CARTON
CONNECTOR (PCS)	900	9000

制图 DRAWN	变更内容 DESCRIPTION	日期 DATE	GENERAL TOLERANCE		制图 DRAWING	EMMA	料号 PART NO.	BX-TYPEC-WTM24-CH18		版本 REV.	A							
			X.±0.30	X.°±10°				审核 CHECK	EVA			品名 TITLE	USB CF 24P SMT TYPE	页次 SHEET	1/1			
			.X±0.20	.X°±8°									核准 APPROVAL			JADE	客户料号 CUTM.NO.	
			.XX±0.10	.XX°±5°														
Bossie (博锡)																		