



Description

The 25N50 uses advanced trench technology and design to provide excellent $R_{DS(ON)}$ with low gate charge. It can be used in a wide variety of applications.

General Features

$V_{DS} = 500V, I_D = 25A$

$R_{DS(ON)} < 240m\Omega @ V_{GS} = 10V$

Application

High efficiency switch mode power supplies

Power factor correction

Electronic lamp ballast

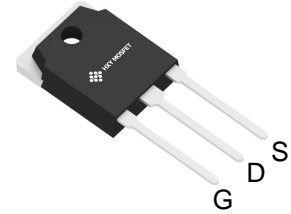

TO-3P

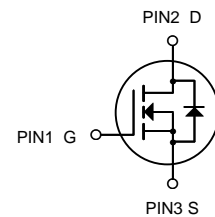

N-Channel MOSFET

Ordering Information

Product ID	Pack	Brand	Units Tube
25N50	TO-3P	HXY MOSFET	50

Absolute Maximum Ratings@ $T_j = 25^\circ C$ (unless otherwise specified)

Symbol	Parameter	Rating	Units
VDS	Drain-Source Voltage	500	V
VGS	Gate-Source Voltage	± 20	V
$I_D @ T_C = 25^\circ C$	Drain Current	25	A
IDM	Pulsed Drain Current ¹	100	A
$P_D @ T_C = 25^\circ C$	Total Power Dissipation	300	W
TSTG	Storage Temperature Range	-55 to 150	$^\circ C$
T_J	Operating Junction Temperature Range	-55 to 150	$^\circ C$



Electrical Characteristics ($T_C=25^{\circ}\text{C}$ unless otherwise noted)

Parameter	Symbol	Condition	Min	Typ	Max	Unit
Off Characteristics						
Drain-Source Breakdown Voltage ^(Note 1)	BV_{DSS}	$V_{GS}=0V, I_D=250\mu A$	500	-	-	V
Zero Gate Voltage Drain Current	I_{DSS}	$V_{DS}=500V, V_{GS}=0V$	-	-	1	μA
Gate-Body Leakage Current	I_{GSS}	$V_{GS}=\pm 20V, V_{DS}=0V$	-	-	± 100	nA
On Characteristics						
Gate Threshold Voltage	$V_{GS(th)}$	$V_{DS}=V_{GS}, I_D=250\mu A$	2.0	-	4.0	V
Drain-Source On-State Resistance	$R_{DS(on)}$	$V_{GS}=10V, I_D=14A$	-	200	240	m Ω
Forward Transconductance	g_{FS}	$V_{DS}=40V, I_D=10A$	-	25	-	S
Dynamic Characteristics						
Input Capacitance	C_{iss}	$V_{DS}=25V, V_{GS}=0V,$ $F=1.0\text{MHz}$	-	3500	-	PF
Output Capacitance	C_{oss}		-	220	-	PF
Reverse Transfer Capacitance	C_{rss}		-	12	-	PF
Switching Characteristics						
Turn-on Delay Time	$t_{d(on)}$	$V_{DD}=400V, I_D=25A$ $R_G=10\Omega$ ^(Note 2)	-	40	-	nS
Turn-on Rise Time	t_r		-	68	-	nS
Turn-Off Delay Time	$t_{d(off)}$		-	88	-	nS
Turn-Off Fall Time	t_f		-	44	-	nS
Total Gate Charge	Q_g	$V_{DS}=400V, I_D=25A,$ $V_{GS}=10V$ ^(Note 2)	-	65	-	nC
Gate-Source Charge	Q_{gs}		-	12	-	nC
Gate-Drain Charge	Q_{gd}		-	20	-	nC
Drain-Source Diode Characteristics						
Diode Forward Voltage	V_{SD}	$V_{GS}=0V, I_S=14A$	-	-	1.4	V
Diode Forward Current ^(Note 2)	I_S		-	-	25	A

Notes:

1. Repetitive Rating: Pulse width limited by maximum junction temperature.
2. Pulse Test: Pulse Width $\leq 300\mu s$, Duty Cycle $\leq 2\%$.



Typical Electrical

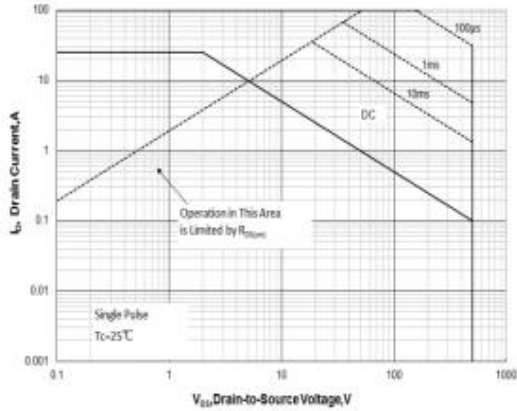

Figure 1 Maximum Forward Bias Safe Operating Area

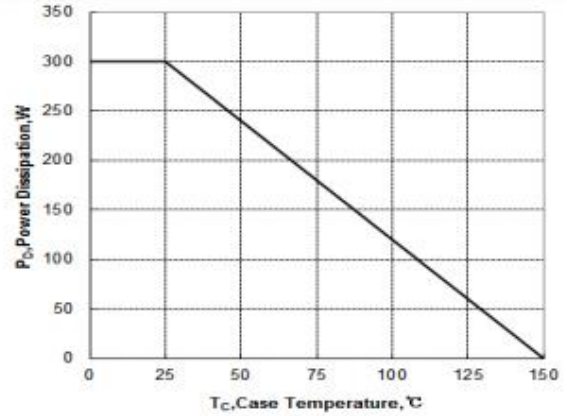

Figure 2 Maximum Power dissipation vs Case Temperature

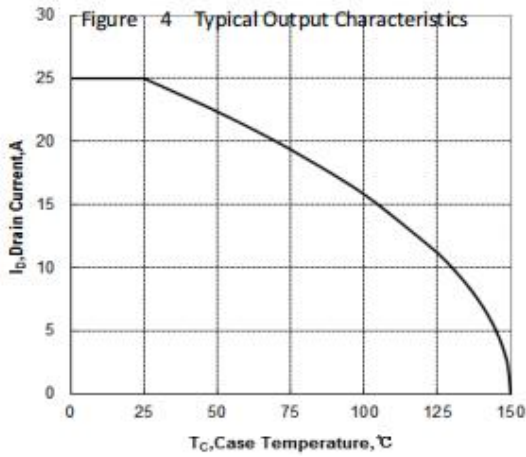

Figure 3 Maximum Continuous Drain Current vs Case Temperature

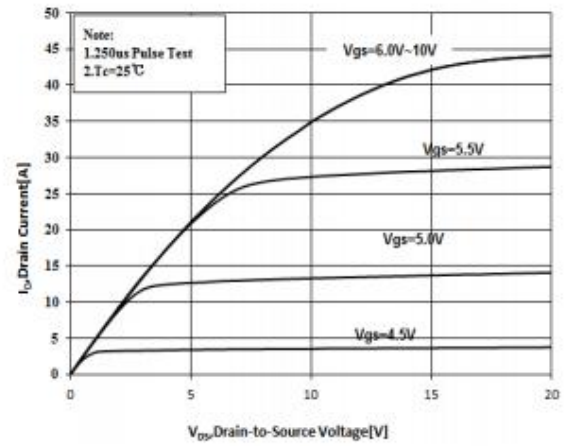

Figure 4 Typical Output Characteristics

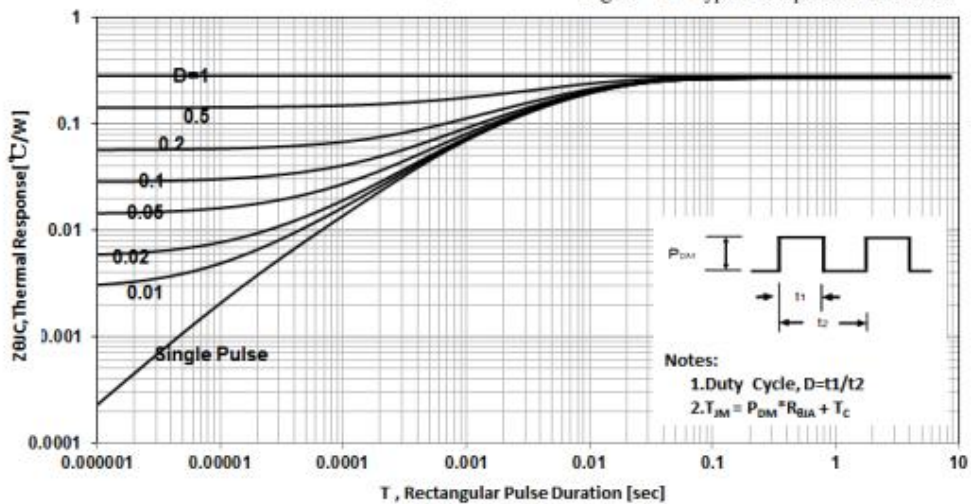

Figure 5 Maximum Effective Thermal Impedance , Junction to Case

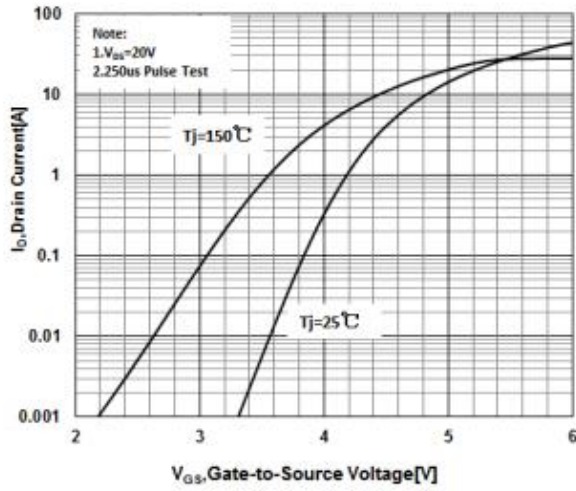

Figure 6 Typical Transfer Characteristics

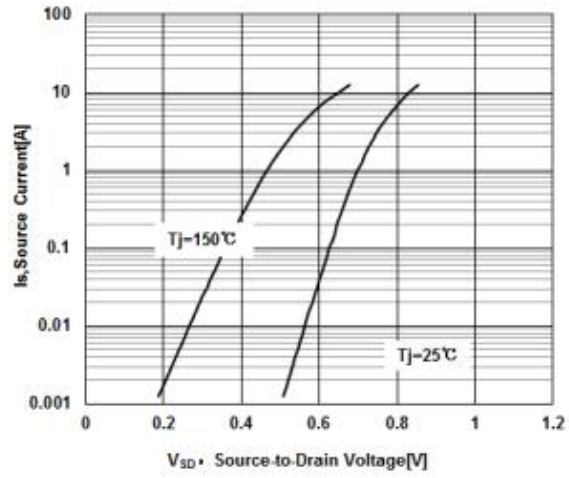

Figure 7 Typical Body Diode Transfer Characteristics

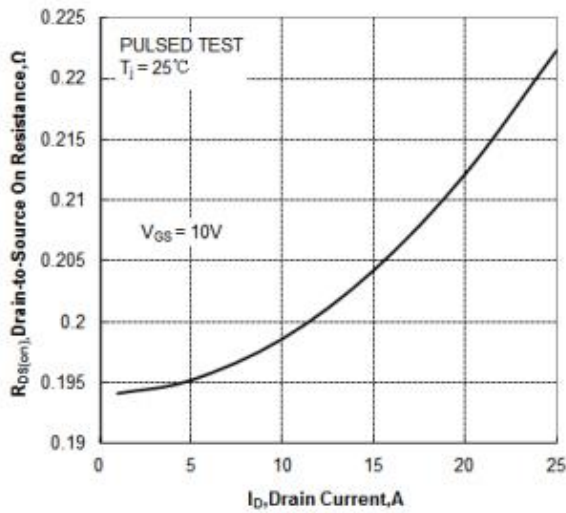

Figure 8 Typical Drain to Source ON Resistance vs Drain Current

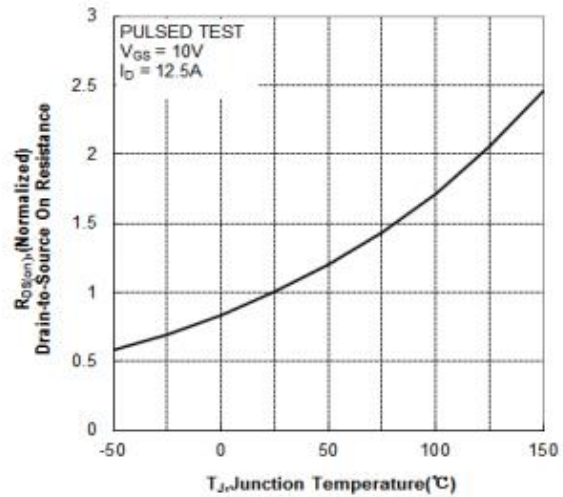

Figure 9 Typical Drain to Source on Resistance vs Junction Temperature

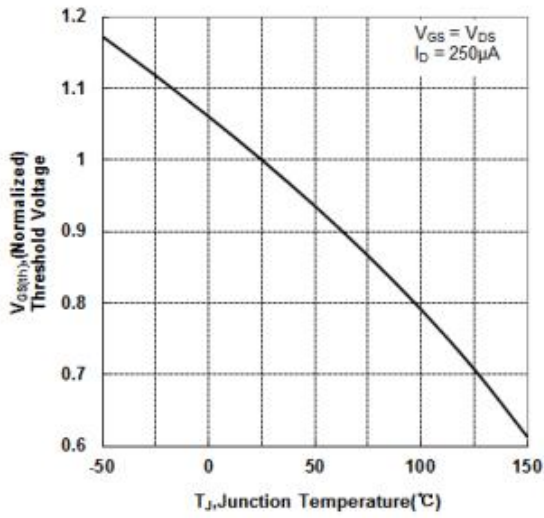

Figure 10 Typical Threshold Voltage vs Junction Temperature

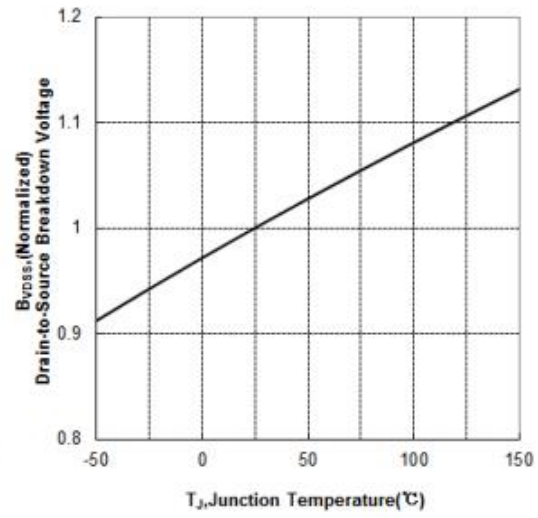

Figure 11 Typical Breakdown Voltage vs Junction Temperature

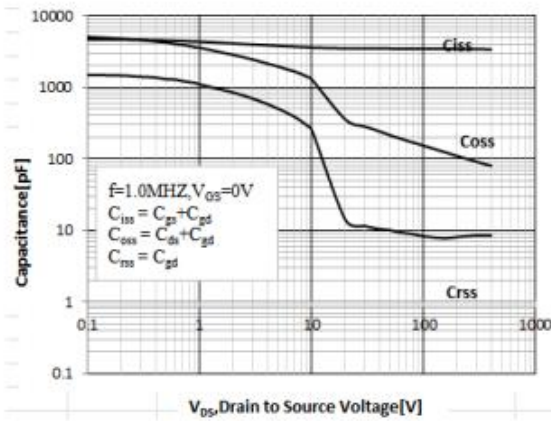

Figure 12 Typical Capacitance vs Drain to Source Voltage

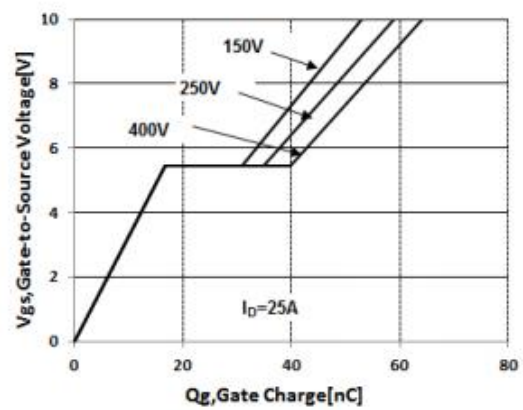
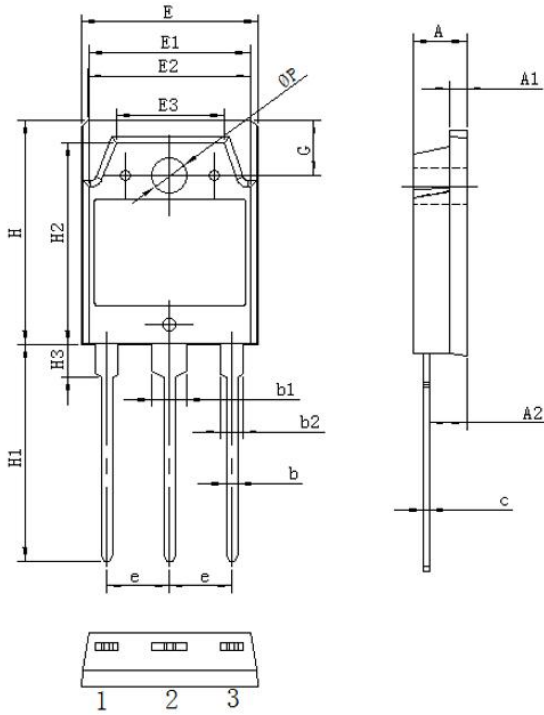

Figure 13 Typical Gate Charge vs Gate to Source Voltage



Package Information

TO-3P



Symbol	单位 mm		
	Min	Nom	Max
A	4.60	4.80	5.00
A1	1.3	1.5	1.7
A2	1.20	1.40	1.60
b	0.80	1.0	1.20
b1	2.90	3.10	3.30
b2	1.90	2.10	2.30
c	0.50	0.60	0.70
e	5.25	5.45	5.65
E	15.2	15.6	16.0
E1	13.2	13.4	13.6
E2	13.1	13.3	13.5
E3	9.1	9.3	9.5
H	19.8	20.0	20.2
H1	20.1	20.3	20.5
H2	18.5	18.7	18.9
H3	3.2	3.5	3.8
G	4.8	5.0	5.2
ΦP	3.00	3.20	3.40



Attention

- Any and all HUA XUAN YANG ELECTRONICS products described or contained herein do not have specifications that can handle applications that require extremely high levels of reliability, such as life-support systems, aircraft's control systems, or other applications whose failure can be reasonably expected to result in serious physical and/or material damage. Consult with your HUA XUAN YANG ELECTRONICS representative nearest you before using any HUA XUAN YANG ELECTRONICS products described or contained herein in such applications.
- HUA XUAN YANG ELECTRONICS assumes no responsibility for equipment failures that result from using products at values that exceed, even momentarily, rated values (such as maximum ratings, operating condition ranges, or other parameters) listed in products specifications of any and all HUA XUAN YANG ELECTRONICS products described or contained herein.
- Specifications of any and all HUA XUAN YANG ELECTRONICS products described or contained herein stipulate the performance, characteristics, and functions of the described products in the independent state, and are not guarantees of the performance, characteristics, and functions of the described products as mounted in the customer's products or equipment. To verify symptoms and states that cannot be evaluated in an independent device, the customer should always evaluate and test devices mounted in the customer's products or equipment.
- HUA XUAN YANG ELECTRONICS CO.,LTD. strives to supply high-quality high-reliability products. However, any and all semiconductor products fail with some probability. It is possible that these probabilistic failures could give rise to accidents or events that could endanger human lives, that could give rise to smoke or fire, or that could cause damage to other property. When designing equipment, adopt safety measures so that these kinds of accidents or events cannot occur. Such measures include but are not limited to protective circuits and error prevention circuits for safe design, redundant design, and structural design.
- In the event that any or all HUA XUAN YANG ELECTRONICS products(including technical data, services) described or contained herein are controlled under any of applicable local export control laws and regulations, such products must not be exported without obtaining the export license from the authorities concerned in accordance with the above law.
- No part of this publication may be reproduced or transmitted in any form or by any means, electronic or mechanical, including photocopying and recording, or any information storage or retrieval system, or otherwise, without the prior written permission of HUA XUAN YANG ELECTRONICS CO.,LTD.
- Information (including circuit diagrams and circuit parameters) herein is for example only ; it is not guaranteed for volume production. HUA XUAN YANG ELECTRONICS believes information herein is accurate and reliable, but no guarantees are made or implied regarding its use or any infringements of intellectual property rights or other rights of third parties.
- Any and all information described or contained herein are subject to change without notice due to product/technology improvement, etc. When designing equipment, refer to the "Delivery Specification" for the HUA XUAN YANG ELECTRONICS product that you intend to use.