



Description

The IRF540N uses advanced trench technology and design to provide excellent $R_{DS(ON)}$ with low gate charge. It can be used in a wide variety of applications.

General Features

$V_{DS} = 100V, I_D = 33A$

$R_{DS(ON)} < 38m\Omega @ V_{GS} = 10V$

Application

High efficiency switch mode power supplies

Power factor correction

Electronic lamp ballast

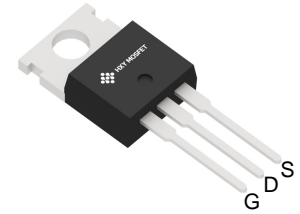

TO-220
(TO-220AB)

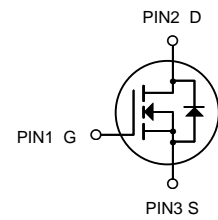

N-Channel MOSFET

Ordering Information

Product ID	Pack	Brand	Units Tube
IRF540N	TO-220(TO-220AB)	HXY MOSFET	50

Absolute Maximum Ratings@ $T_j = 25^\circ C$ (unless otherwise specified)

Symbol	Parameter	Rating	Units
V _{DS}	Drain-Source Voltage	100	V
V _{GS}	Gate-Source Voltage	± 20	V
I _D @T _C =25°C	Drain Current	33	A
IDM	Pulsed Drain Current ¹	120	A
P _D @T _C =25°C	Total Power Dissipation	130	W
TSTG	Storage Temperature Range	-55 to 150	°C
T _J	Operating Junction Temperature Range	-55 to 150	°C



Electrical Characteristics (T_C=25°C unless otherwise noted)

Parameter	Symbol	Condition	Min	Typ	Max	Unit
Off Characteristics						
Drain-Source Breakdown Voltage ^(Note 1)	BV _{DSS}	V _{GS} =0V, I _D =250μA	100	-	-	V
Zero Gate Voltage Drain Current	I _{DSS}	V _{DS} =100V, V _{GS} =0V	-	-	1	μA
Gate-Body Leakage Current	I _{GSS}	V _{GS} =±20V, V _{DS} =0V	-	-	±100	nA
On Characteristics						
Gate Threshold Voltage	V _{GS(th)}	V _{DS} =V _{GS} , I _D =250μA	2.0	-	4.0	V
Drain-Source On-State Resistance	R _{DS(ON)}	V _{GS} =10V, I _D =15A	-	30	38	mΩ
Forward Transconductance	g _{FS}	V _{DS} =10V, I _D =20A	45	-	-	S
Dynamic Characteristics						
Input Capacitance	C _{iss}	V _{DS} =50V, V _{GS} =0V, F=1.0MHz	-	1280	-	PF
Output Capacitance	C _{oss}		-	300	-	PF
Reverse Transfer Capacitance	C _{rss}		-	26	-	PF
Switching Characteristics						
Turn-on Delay Time	t _{d(on)}	V _{DD} =50V, I _D =15A R _G =4.7Ω ^(Note 2)	-	12	-	nS
Turn-on Rise Time	t _r		-	18	-	nS
Turn-Off Delay Time	t _{d(off)}		-	23	-	nS
Turn-Off Fall Time	t _f		-	6	-	nS
Total Gate Charge	Q _g	V _{DS} =50V, I _D =30A, V _{GS} =10V ^(Note 2)	-	20	-	nC
Gate-Source Charge	Q _{gs}		-	10	-	nC
Gate-Drain Charge	Q _{gd}		-	5	-	nC
Drain-Source Diode Characteristics						
Diode Forward Voltage	V _{SD}	V _{GS} =0V, I _S =15A	-	-	1.4	V
Diode Forward Current ^(Note 2)	I _S		-	-	33	A

Notes:

1. Repetitive Rating: Pulse width limited by maximum junction temperature.
2. Pulse Test: Pulse Width ≤ 300μs, Duty Cycle ≤ 2%.



Typical Electrical

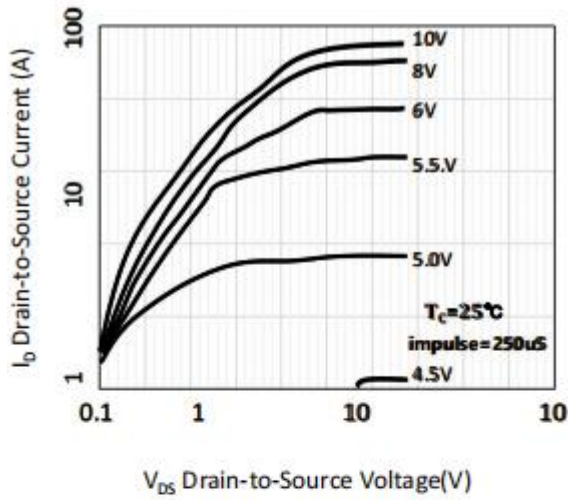

Figure 1. Typical Output Characteristics

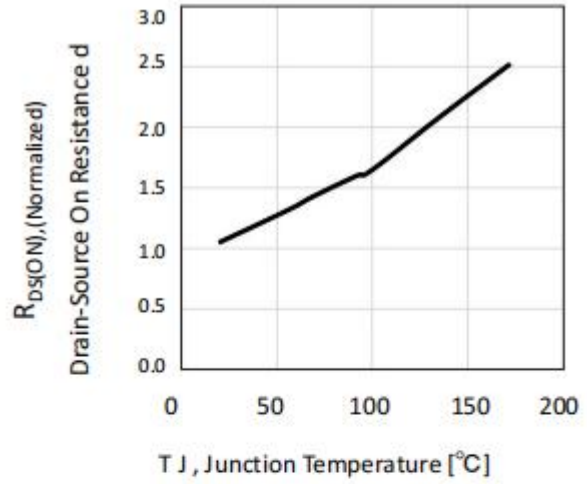

Figure 2. Typical Output Characteristics

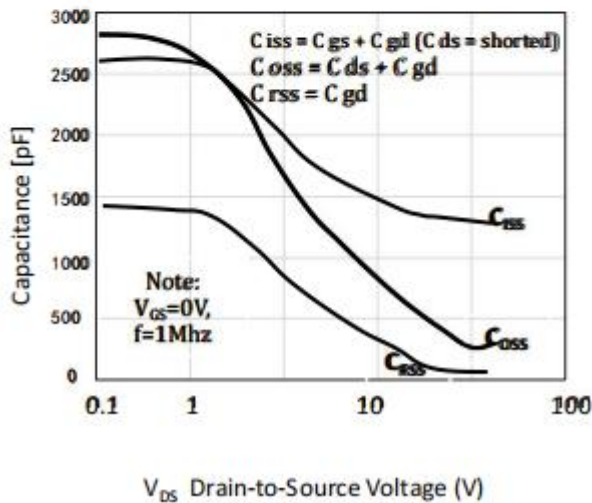

Figure 3. Typical Capacitance Vs Drain-Source Voltage

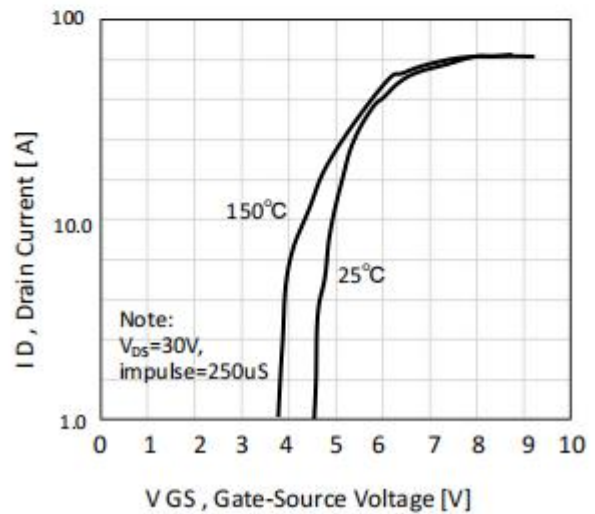

Figure 4. On-Resistance Vs Drain Current

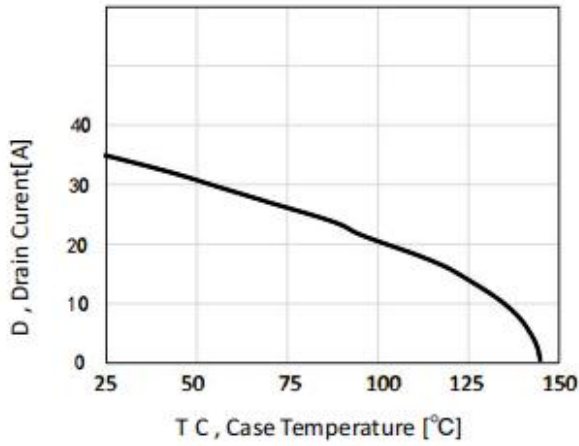

Figure 5. Maximum Drain Current Vs Temperature

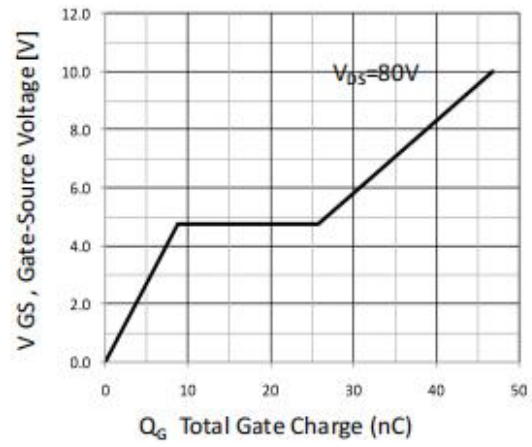

Figure 6. Typical Gate Charge Vs Gate-Source Voltage

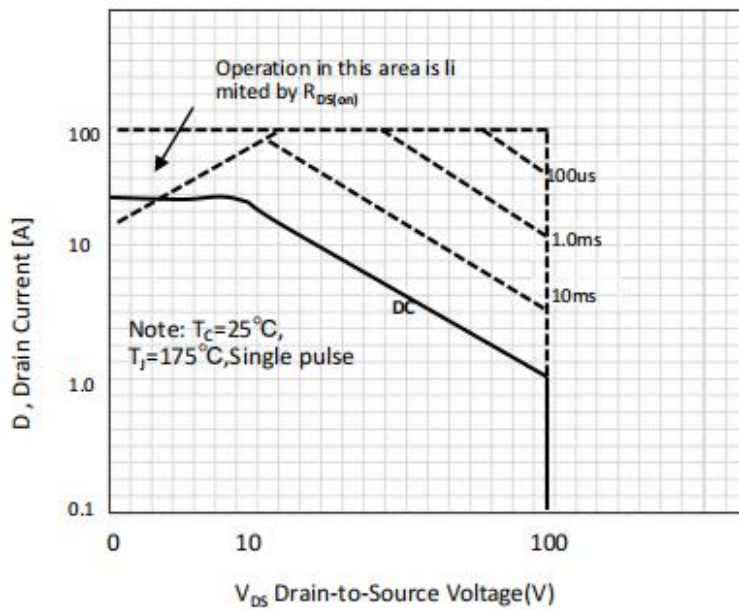
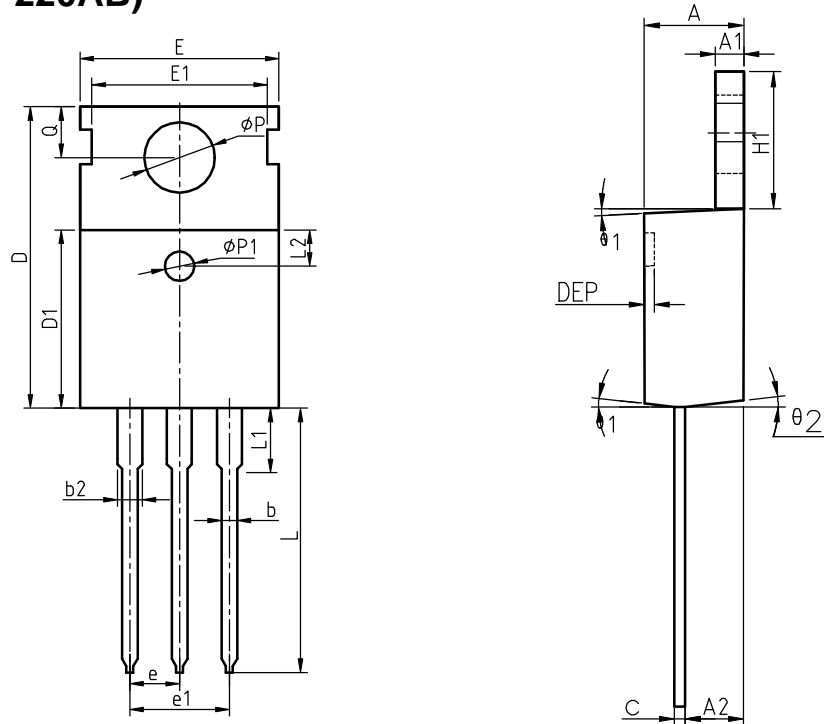

Figure 7. Maximum Safe Operating Area



Package Information

TO-220(TO-220AB)



COMMON DIMENSIONS

SYMBOL	MIN	NOM	MAX	MIN	NOM	MAX
A	4.40	4.57	4.70	0.173	0.180	0.185
A1	1.27	1.30	1.33	0.050	0.051	0.052
A2	2.35	2.40	2.50	0.093	0.094	0.098
b	0.77	0.80	0.90	0.030	0.031	0.035
b2	1.17	1.27	1.36	0.046	0.050	0.054
c	0.48	0.50	0.56	0.019	0.020	0.022
D	15.40	15.60	15.80	0.606	0.614	0.622
D1	9.00	9.10	9.20	0.354	0.358	0.362
DEP	0.05	0.10	0.20	0.002	0.004	0.008
E	9.80	10.00	10.20	0.386	0.394	0.402
E1	-	8.70	-	-	0.343	-
E2	9.80	10.00	10.20	0.386	0.394	0.402
e		2.54	BSC		0.100	BSC
e1		5.08	BSC		0.200	BSC
H1	6.40	6.50	6.60	0.252	0.256	0.260
L	12.75	13.50	13.65	0.502	0.531	0.537
L1	-	3.10	3.30	-	0.122	0.130
L2		2.50	REF		0.098	REF
P	3.50	3.60	3.63	0.138	0.142	0.143
P1	3.50	3.60	3.63	0.138	0.142	0.143
Q	2.73	2.80	2.87	0.107	0.110	0.113
theta 1	5°	7°	9°	5°	7°	9°
theta 2	1°	3°	5°	1°	3°	5°
theta 3	1°	3°	5°	1°	3°	5°

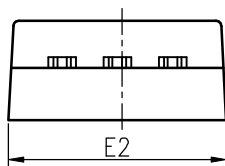



Attention

- Any and all HUA XUAN YANG ELECTRONICS products described or contained herein do not have specifications that can handle applications that require extremely high levels of reliability, such as life-support systems, aircraft's control systems, or other applications whose failure can be reasonably expected to result in serious physical and/or material damage. Consult with your HUA XUAN YANG ELECTRONICS representative nearest you before using any HUA XUAN YANG ELECTRONICS products described or contained herein in such applications.
- HUA XUAN YANG ELECTRONICS assumes no responsibility for equipment failures that result from using products at values that exceed, even momentarily, rated values (such as maximum ratings, operating condition ranges, or other parameters) listed in products specifications of any and all HUA XUAN YANG ELECTRONICS products described or contained herein.
- Specifications of any and all HUA XUAN YANG ELECTRONICS products described or contained herein stipulate the performance, characteristics, and functions of the described products in the independent state, and are not guarantees of the performance, characteristics, and functions of the described products as mounted in the customer's products or equipment. To verify symptoms and states that cannot be evaluated in an independent device, the customer should always evaluate and test devices mounted in the customer's products or equipment.
- HUA XUAN YANG ELECTRONICS CO.,LTD. strives to supply high-quality high-reliability products. However, any and all semiconductor products fail with some probability. It is possible that these probabilistic failures could give rise to accidents or events that could endanger human lives, that could give rise to smoke or fire, or that could cause damage to other property. When designing equipment, adopt safety measures so that these kinds of accidents or events cannot occur. Such measures include but are not limited to protective circuits and error prevention circuits for safe design, redundant design, and structural design.
- In the event that any or all HUA XUAN YANG ELECTRONICS products(including technical data, services) described or contained herein are controlled under any of applicable local export control laws and regulations, such products must not be exported without obtaining the export license from the authorities concerned in accordance with the above law.
- No part of this publication may be reproduced or transmitted in any form or by any means, electronic or mechanical, including photocopying and recording, or any information storage or retrieval system, or otherwise, without the prior written permission of HUA XUAN YANG ELECTRONICS CO.,LTD.
- Information (including circuit diagrams and circuit parameters) herein is for example only ; it is not guaranteed for volume production. HUA XUAN YANG ELECTRONICS believes information herein is accurate and reliable, but no guarantees are made or implied regarding its use or any infringements of intellectual property rights or other rights of third parties.
- Any and all information described or contained herein are subject to change without notice due to product/technology improvement, etc. When designing equipment, refer to the "Delivery Specification" for the HUA XUAN YANG ELECTRONICS product that you intend to use.