

技术指标:

1. 额定电流: 0.5A
2. 温度范围: -40~85℃
3. 额定电压: 50V, AC/DC (等效)
4. 接触电阻: $\leq 0.03\Omega$
5. 绝缘电阻: $\geq 500M\Omega$

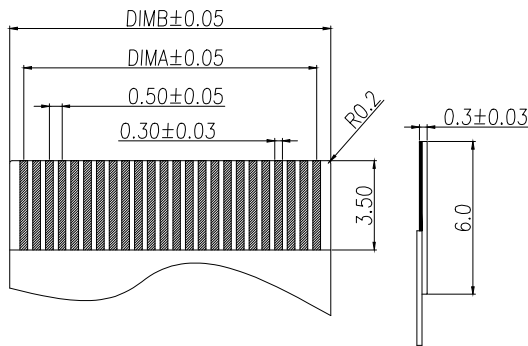

Part No	Pin	A	B	C
BX-0.5FPC-2H-LZ4P	4	1.50	2.60	7.60
BX-0.5FPC-2H-LZ5P	5	2.00	3.10	8.10
BX-0.5FPC-2H-LZ6P	6	2.50	3.60	8.60
BX-0.5FPC-2H-LZ7P	7	3.00	4.10	9.10
BX-0.5FPC-2H-LZ8P	8	3.50	4.60	9.60
BX-0.5FPC-2H-LZ9P	9	4.00	5.10	10.10
BX-0.5FPC-2H-LZ10P	10	4.50	5.60	10.60
BX-0.5FPC-2H-LZ11P	11	5.00	6.10	11.10
BX-0.5FPC-2H-LZ12P	12	5.50	6.60	11.60
BX-0.5FPC-2H-LZ13P	13	6.00	7.10	12.10
BX-0.5FPC-2H-LZ14P	14	6.50	7.60	12.60
BX-0.5FPC-2H-LZ15P	15	7.00	8.10	13.10
.....
BX-0.5FPC-2H-LZ60P	60	$(60-1)*0.5$	$(60+1)*0.5+0.1$	$(60+11)*0.5+0.1$

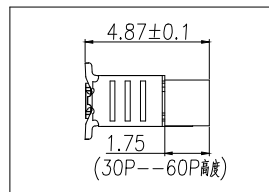
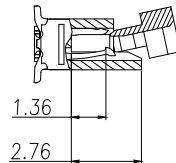
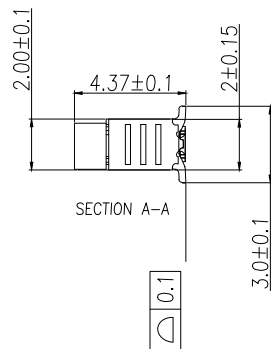
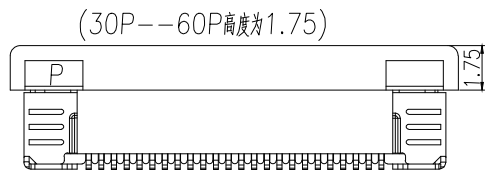
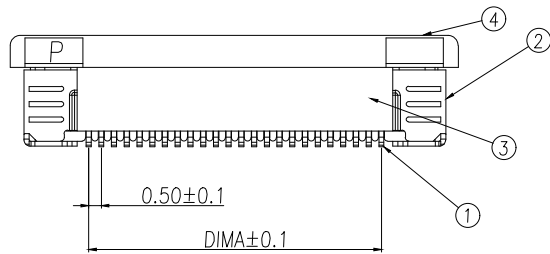
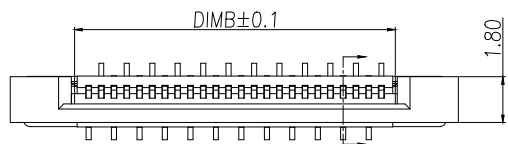
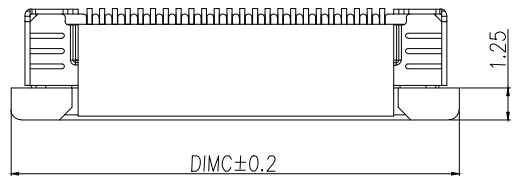
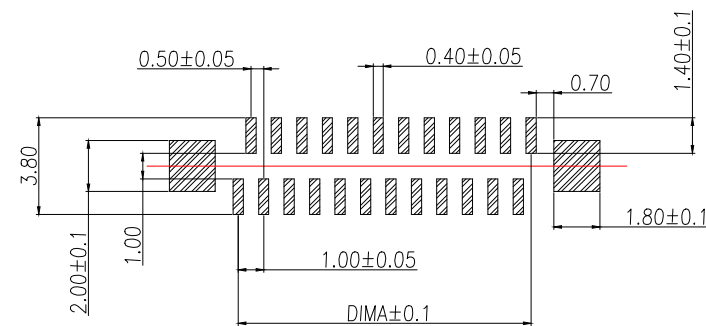

序号	品名	材质	制图 DRAWN	变更内容 DESCRIPTION	日期 DATE	GENERAL TOLERANCE		制图 DRAWING	EMMA	料号 PART NO.	BX-0.5FPC-2H-LZNP	版本 REV.	A
						X. ± 0.15	X.* ± 5°						
1	端子	磷青铜/表面镀锡				.X ± 0.10	.X* ± 1°	核准 APPROVAL	JADE	客户料号 CUTM.NO.			
2	焊片	黄铜/表面镀锡				.XX ± 0.05	.XX* ± 0.5°	单位 UNITS	MM	比例 SCALE	1:1		
3	基座	LCP UL94V-0 本色											
4	锁条	LCP UL94V-0 黑色											