



温州康宏电子有限公司
WENZHOU KHAN ELECTRONIC CO.,LTD.

产品承认书

SPECIFICATION FOR APPROVAL

客户名称 Customer: _____	客户代码 Customer Code: _____
客户料号 Customer NO.: _____	本公司料号 Model NO.: <u>TSR06631-050D531KD-R1000</u>
规格名称 Description: <u>6*6*5防水轻触开关</u>	日期 Date: <u>2026.02.08</u>

<input type="checkbox"/> 新品承认 New Product Approve		<input type="checkbox"/> 规格变更承认 Description Change Approve		<input type="checkbox"/> 材料变更承认 Material Change Approve	
设计 Designed	余嘉诚 2026.02.08	审核 Checked	朱树清 2026.02.08	批准 Approved	徐君辉 2026.02.08

客户确认栏 Customer approval

采购 Purchase Dept.	品质 QC Dept.	工程 Engineering Dept.	批准 Approved

结论 Conclusion	<input type="checkbox"/> 合格 Qualified	<input type="checkbox"/> 重新送样 Sample Test Again	<input type="checkbox"/> 不合格 Unqualified
------------------	--	--	---

地址: 浙江省乐清市宋湖工业区汇丰路 92 号 邮编: 325600
 Add: NO.92 Huifeng Road, Songhu Ind. Zone, Yueqing
 325600, Zhejiang, China
 Tel: 0577-62533000 61522500 62532000
 Fax: 0577-62078255 62530255



ISO9001 ISO14001 ISO45001

	产品承认书	产品名称 Product name	轻触开关 Tact Switch	版本 Edition	A
	SPECIFICATION	型号 Model	TSR06631-050	页码 Page	1/8

1、概述

General

1.1 适用范围

Application

此承认书适用与机械式轻触开关的相关要求

This specification is applied to the requirements for Tact Switch (Mechanical Contact)

1.2 工作温度范围

Operating Temperature Range

-40℃~85℃ (在标准大气压、标准湿度条件下)

-40℃~85℃ (Normal humidity,normal air pressure)

1.3 贮存环境

Storage environment

开关应贮存在温度为-5~30℃、相对湿度不大于 65%, 周围空气中无酸、碱、硫或其它腐蚀性气体的库房中。

The switch should be stored in warehouse which temperature of -5~30℃, relative humidity of not more than 65%, no acid, alkali, sulfur and other corrosive gases in the ambient air

1.4 测试条件

Test Conditions

在没有其他特定的条件下, 应该在以下的条件进行测试和测量:

Unless otherwise specified, tests and measurements shall be made in the following standard conditions:

常温.....5℃~35℃

Normal Temperature.....5℃~35℃

相对湿度.....65%±5%

Normal Humidity65%±5%

标准大气压.....86KPa~106KPa

Normal air pressure86KPa~106KPa

在制造过程中, 测试和测量应该在以下的条件下进行:

If any doubt arise from the judgment, test shall be conducted at the following conditions:

温度.....20℃±2℃

Temperature20℃±2℃

相对湿度.....65%±5%

Relative humidity65%±5%

环境气压.....86KPa~106KPa

Air pressure86KPa~106KPa

	产品承认书	产品名称 Product name	轻触开关 Tact Switch	版本 Edition	A
	SPECIFICATION	型号 Model	TSR06631-050	页码 Page	2/8

2、详细说明

Detailed specification

2.1 外观：应无影响、降低产品性能的缺陷；

Appearance: There should be no defects that affect the serviceability of product.

2.2 结构尺寸和安装尺寸：应符合装配图要求；

Structure and dimension: shall conform to the assemble drawings.

2.3 操作形式：有触觉反应的操作

Type of actuating: Tactile feedback.

2.4 开关结构：单回路单输出（具体的触点结构在装配图中已绘出）

Contact arrangement: 1 pole, 1 throw

(Details of contact arrangement are given in the assembly drawings)

2.5 开关工作额定值：DC 12V, 50mA（有效值）

Ratings: 12V DC, 50mA (effective value)

3、电气性能：

Electrical Specification

项目 Item	试验条件 Test Conditions	要求 Requirements
3.1 接触电阻 Contact Resistance	在以 5V 10mA 的直流电源或不低于 1KHz 的交流电源的电路中，以一个等于 2 倍按力的静负荷施加于手柄中心 Applying a static load of 2 times operating force to the center of the stem, measurement shall be made by 5V DC 10mA or more than 1KHz AC small-current contact resistance meter.	$\leq 100\text{m}\Omega$
3.2 绝缘电阻 Insulation Resistance	在端子之间施加 DC 100V/1min 的条件下，测量端子之间底座、盖板的电阻值 Measurement shall be made following application of 100V DC potential, across terminals, and across terminals and cover, for one minute.	$\geq 100\text{M}\Omega$
3.3 介质耐压 Dielectric voltage proof	在端子之间施加 250V AC (50Hz 或 60Hz) /1min 250V AC (50Hz or 60Hz) shall be applied across terminals, for one minute.	无击穿、无飞弧 There should be no breakdown and flashover

	产品承认书	产品名称 Product name	轻触开关 Tact Switch	版本 Edition	A
	SPECIFICATION	型号 Model	TSR06631-050	页码 Page	3/8
项目 Item		试验条件 Test Conditions		要求 Requirements	
4.机械性能: Mechanical Specification					
4.1	按力 Operating Force	<p>开关垂直于操作方向放置，在开关驱动件顶端中心逐渐施力，测量开关导通所需的最大力度。</p> <p>Placing the switch such that the direction of switch operation is vertical and then gradually the load applied to the center of the stem, the maximum load required of the switch to come to a stop shall be measured.</p>		<p>280gf±50gf 详见附页 1 开关（荷重-行程）曲线 See Appendix 1 Switch (load - travel) test chart</p>	
4.2	最大行程 Full Travel	<p>开关垂直于操作方向放置，以一个等于 2 倍按力的静负荷施加在开关驱动件顶端中心，测量顶端移动的距离。</p> <p>Placing the switch such that the direction of switch operation is vertical and then applying static load of 2 times operating force to the center of the stem:the travel distance for the switch to come to a stop shall be measured.</p>		<p>0.3±0.1mm 详见附页 1 开关（荷重-行程）曲线测 试图 See Appendix 1 Switch (load - travel) test chart</p>	
4.3	回弹力 Return Force	<p>开关垂直于操作方向放置，在开关驱动件顶端中心下降至全行程后，测量顶端向自由位置转换的力度。</p> <p>The sample switch is installed such that the direction of switch operation is vertical and upon depressing the stem in its center to the whole travel distance, the force of the stem to return to its free position shall be measured.</p>		<p>≥40gf 详见附页 1 开关（荷重-行程）曲线测 试图 See Appendix 1 Switch (load - travel) test chart</p>	
4.4	静止强度 Stop Strength	<p>开关垂直于操作方向放置，从操作方向向驱动件施加 30N 的静负荷持续 60 秒。</p> <p>Placing the switch such that the direction of switch operation is vertical, and then a static load of 30N shall be applied in the direction of stem operation for a period of 60 s.</p>		<p>无机械和电气损坏 There shall be no sign of damage mechanically and electrically</p>	

	产品承认书	产品名称 Product name	轻触开关 Tact Switch	版本 Edition	A
	SPECIFICATION	型号 Model	TSR06631-050	页码 Page	4/8
项目 Item		试验条件 Test Conditions		要求 Requirements	
4.5	手柄拔出强度 Stem Strength	<p>开关垂直于操作方向放置，手柄应能承受反方向实施20N.min.操作力。</p> <p>The switch shall be placed perpendicular to the operating direction, and the handle shall be able to withstand the operating force of 20 N.min. applied in the opposite direction.</p>		<p>试验后手柄、盖板应无脱落、破损，开关应能动作</p> <p>After the test, the handle and cover plate should be free of falling off and damage, and the switch should be able to operate</p>	
4.6	接线端强度 Terminals Strength	<p>开关接线端应能承受 10N 轴向拉力 10s±1s 的作用。</p> <p>Switch terminals should be able to withstand the axial tension of 10N for 10s + 1s.</p>		<p>试验后接线端子应无脱落、破损，开关应能动作</p> <p>After the test terminals should be without any fall off, damage, the switch should be able to function</p>	
4.7	可焊性 Solderability	<p>把试验样品需要焊接的部位浸入焊锡炉中进行测试：</p> <p>Immerse the part of the test sample that needs to be soldered into the soldering furnace for testing:</p> <p>(1) 锡炉温度：245±5℃ Solder temperature:245±5℃</p> <p>(2) 浸入时间：2±0.5s Immersion time: 2±0.5s</p> <p>对于其它步骤参考《GB5095.6-86》试验 12a The other steps please refer to 《GB5095.6-86》TEST 12a</p>		<p>接线端粘锡面积≥95% (除边缘外)</p> <p>Except for the edge, the coating should cover a minimum 95% (Except edges)</p>	
5.极限电气性能： Environmental Specification					
5.1	低温测试 Resistance to low temperature	<p>样品应按照以下试验条件进行测试，试验后样品应放在常温及标准湿度的环境 1 小时做性能测试：</p> <p>Following the test set forth below the sample shall be left in normal temperature and humidity conditions for 1 h before measurements are made:</p> <p>(1) 温度：-40±2℃ Temperature: -40±2℃</p> <p>(2) 时间：96h time: 96h</p>		<p>接触电阻：≤200mΩ Contact resistance: ≤200mΩ</p> <p>绝缘电阻：≥10MΩ Insulation resistance: ≥10MΩ</p> <p>项目：3.3,4.1,4.2,4.3 Item: 3.3,4.1,4.2,4.3</p>	

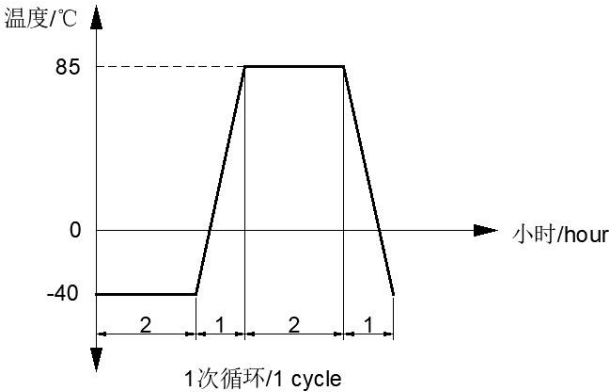
	产品承认书 Product name	产品名称 Product name 轻触开关 Tact Switch	版本 Edition A
	SPECIFICATION	型号 Model TSR06631-050	页码 Page 5/8
项目 Item	试验条件 Test Conditions		要求 Requirements
5.2 高温测试 Heat resistance	<p>样品应按照以下试验条件进行测试, 试验后样品应放在常温及标准湿度的环境中 1 小时做性能测试:</p> <p>Following the test set forth below the sample shall be left in normal temperature and humidity conditions for 1 h before measurements are made:</p> <p>(1) 温度: $85\pm 2^{\circ}\text{C}$ Temperature: $85\pm 2^{\circ}\text{C}$</p> <p>(2) 时间: 96h time: 96h</p>		接触电阻: $\leq 200\text{m}\Omega$ Contact resistance: $\leq 200\text{m}\Omega$ 绝缘电阻: $\geq 10\text{M}\Omega$ Insulation resistance: $\geq 10\text{M}\Omega$ 项目: 3.3,4.1,4.2,4.3 Item: 3.3,4.1,4.2,4.3
5.3 温度周期性测试 Change of temperature	<p>根据下面的测试要求进行 5 次循环的温度周期性测试, 试验后样品应放在常温及标准湿度的环境中 1 小时后做性能测试。测试期间样品应保持干燥。</p> <p>After 5 cycles of following conditions, the sample shall be allowed to stand under normal temperature and humidity conditions for 1 h. and measurements shall be made. During the test water drops shall be removed.</p>  <p>1次循环/1 cycle</p>		接触电阻: $\leq 200\text{m}\Omega$ Contact resistance: $\leq 200\text{m}\Omega$ 绝缘电阻: $\geq 10\text{M}\Omega$ Insulation resistance: $\geq 10\text{M}\Omega$ 项目: 3.3,4.1,4.2,4.3 Item: 3.3,4.1,4.2,4.3
5.4 湿温测试 Moisture resistance	<p>样品应按照以下试验条件进行测试, 试验后样品应放在常温及标准湿度的环境中 1 小时做性能测试:</p> <p>Following the test set forth below the sample shall be left in normal temperature and humidity conditions for 1 h before measurements are made:</p> <p>(1) 温度: $60\pm 2^{\circ}\text{C}$ Temperature: $60\pm 2^{\circ}\text{C}$</p> <p>(2) 相对湿度: 90%~95% relative humidity: 90% to 95%</p> <p>(3) 时间: 96h time: 96h</p> <p>(4) 擦除水珠 Water drops shall be removed.</p>		接触电阻: $\leq 200\text{m}\Omega$ Contact resistance: $\leq 200\text{m}\Omega$ 绝缘电阻: $\geq 10\text{M}\Omega$ Insulation resistance: $\geq 10\text{M}\Omega$ 项目: 3.3,4.1,4.2,4.3 Item: 3.3,4.1,4.2,4.3

	产品承认书 SPECIFICATION		产品名称 Product name	轻触开关 Tact Switch	版本 Edition A
			型号 Model	TSR06631-050	页码 Page 6/8
项目 Item		试验条件 Test Conditions		要求 Requirements	
5.5	盐雾试验 Salt Mist	在以下设定条件下进行测量： The switch shall checked after following test: (1) 温度：35±2℃ Temperature: 35±2℃ (2) 盐溶液浓度：5±1%（质量百分比） salt solution: 5±1%(solids by mass) (3) 时间：48±1h time: 48±1h		金属上没有腐蚀斑点 No remarkable corrosion shall be recognized in metal part	
5.6	IP 测试 IP test	IP67（防水等级）在以下设定条件下进行测量： IP67 (Waterproof grade)is measured under the following setting conditions: 开关在水深 1m 处持续 30 分钟，开关内部无水进入，取出晾干后测试。 Keep the switch at the water depth of 1 m for 30 minutes, no water will enter the switch, take it out and dry it before testing.		接触电阻：≤200mΩ Contact resistance: ≤200mΩ 绝缘电阻：≥10MΩ Insulation resistance: ≥10MΩ 项目：3.3,4.1,4.2,4.3 Item: 3.3,4.1,4.2,4.3	
6.极限机械性能： Endurance Specification					
6.1	工作寿命 Operation life	根据下面的测试要求进行测试： Measurement shall be made following the test set forth below: (1) DC 12V, 50mA 带负载 DC 12V,50 mA resistive load (2) 按动速率：2 次/秒 Rate of operation: 2 times/s (3) 按力：按力的 1.5 倍 Operating Force: Operating Force 1.5 times (4) 平均无故障寿命：≥10 0000 Average Life Expectancy: ≥100,000		接触电阻≤500mΩ Contact resistance ≤500mΩ 按力：初值的±30% Operating Force: initial value ±30% 项目：3.3,4.2,4.3 Item: 3.3,4.2,4.3	

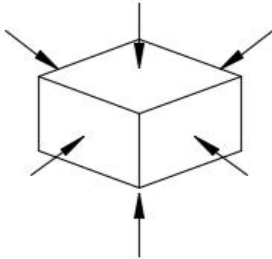
	产品承认书 SPECIFICATION	产品名称 Product name	轻触开关 Tact Switch	版本 Edition	A
		型号 Model	TSR06631-050	页码 Page	7/8
项目 Item		试验条件 Test Conditions		要求 Requirements	
6.2	耐冲击 Impact Shock Resistance	<p>加速度 500m/s²，脉冲持续时间 11ms，三个轴线的每个方向上，每个方向三次，共 18 次。</p> <p>Acceleration of 500m/s², pulse duration 11ms, each direction of the 3 axis, 3 times in each direction, a total 18 times.</p> 		项目： 3,4.1,4.2,4.3 Item: 3,4.1,4.2,4.3	
7.焊接条件： Soldering Conditions:					
7.1	手工焊接 Hand soldering	<p>请按以下条件进行焊接：</p> <p>Please practice according to below conditions:</p> <p>(1) 焊锡温度： ≤350℃ Soldering temperature: 350℃ Max</p> <p>(2) 连续焊接时间： ≤3s Continuous soldering time: 3s Max</p>			

	产品承认书	产品名称 Product name	轻触开关 Tact Switch	版本 Edition	A
	SPECIFICATION	型号 Model	TSR06631-050	页码 Page	8/8

项目 Item	试验条件 Test Conditions	要求 Requirements
------------	-------------------------	--------------------

7.2	波峰焊 Conditions for wave soldering 适用于直插式开关 Applied to plug-in switch	项目 Items	条件 Condition
		助焊剂附着量 Flux built-up	不附着于零部件贴装面的程度 Mounting surface should not be coated with flux
		预热温度 Preheating temperature	印刷电路板焊接面的周围温度 100°C max Ambient temperature of the soldered surface of PC board. 100°C max
		预热温度时间 Preheating time	60s max
		焊接温度 Soldering temperature	260°C max
		焊接浸渍时间 Continuous dipping time	5s max
		焊接次数 Number of soldering	2 次以下 2 times max
		由于 PCB 的材料、尺寸、厚度等不同，PCB 从开关表面获得的温度也会有很大不同，因此，焊接时千万小心不要让开关表面温度超过 240°C。 Due to the difference of PCB material, size and thickness, the temperature obtained by PCB from the switch surface will also be very different. Therefore, be careful not to let the switch surface temperature exceed 240 °C during welding	

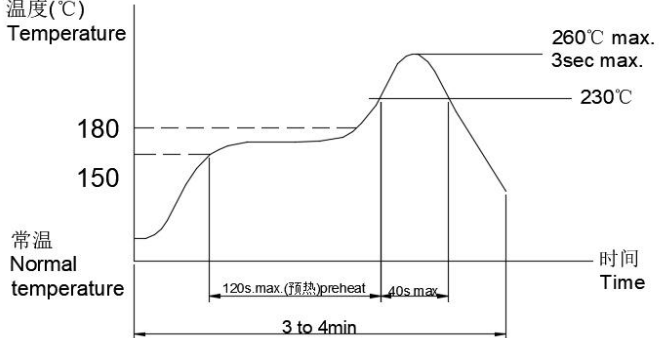
7.3	回流焊 Conditions for reflow soldering 适用贴片式开关 Applied to surface mount switch	 <p>温度(°C) Temperature</p> <p>180 150 常温 Normal temperature</p> <p>120s max (预热) preheat 40s max 3 to 4min</p> <p>260°C max. 3sec max. 230°C</p> <p>时间 Time</p>
-----	--	---

注意事项:

Cautions:

- 开关浸焊后，注意不要用溶剂清洗开关。
After switches were soldered, please do not clean switches with solvent.
- 防止助焊剂从开关的上部流入到开关的内部。
Safeguards the switch assembly against flux penetration from its solvent.
- 注意不要施加超负荷的压力或晃动开关。
Please be cautions not to give excessive static load or shock to switches.
- 开关浸焊后，印刷基板注意不要叠放。
Please be careful not to pile up P.W.B. after switches were soldered.

5、保管时尤其应注意避开高湿高温和有腐蚀性气体的环境。如需要长时间保存，请不要打开包装箱。如已拆包物料未使用完，请及时按原包装方式密封保存。

Pay special attention to avoid the environment with high humidity, high temperature and corrosive gas during storage. If it needs to be stored for a long time, please do not open the packing box. If the unpacked materials are not used up, please seal them in time according to the original packaging method.

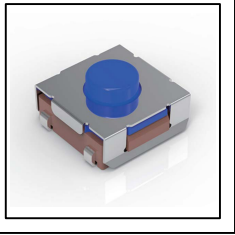

产品规格

工作方式: 瞬时接触
 触点形式: 单刀单掷
 安装方式: 直立贴片

机械性能

动作力: 280±50gf
 电气寿命: 10,0000 次

工作环境

环境温度: -40~+85℃
 环境湿度: (40℃) ≤95%

电气性能

额定电负荷: 50mA @ 12V DC
 耐电压: 250VAC /1分
 接触电阻: 100Ω Max.
 绝缘电阻: 100MΩ Min.
 行程: 0.3±0.1mm
 IP等级: IP67

物料

5. 盖板: 不锈钢
 4. 手柄: 硅胶 蓝色
 3. 簧片: 不锈钢镀银
 2. 底座: PPA 咖啡色
 1. 接线片: 黄铜 镀银

包装

散装
 内包装: 编带
 外包装: 纸箱

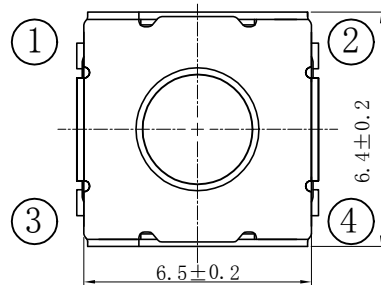
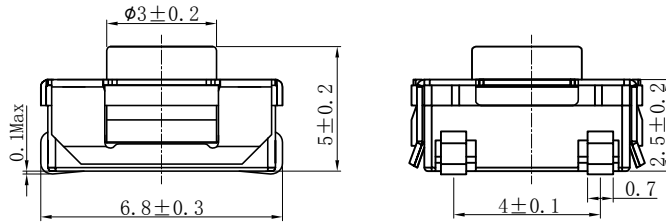

CIRCUIT DIAGRAM

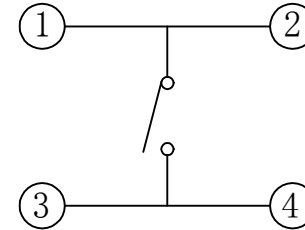

P.C.B. LAYOUT

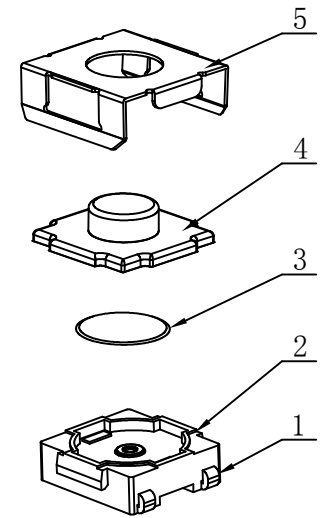
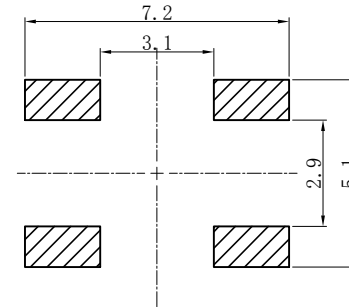

借通用件登记

描 图

校 描

旧底图总号

签 字

日 期

					轻触开关		TSR06631-050D531KD-R1000			
标记	处数	更改文件号	签名	日期	视图		阶段	标记	质量	比例
设计	余嘉诚									1:1
审核	朱树清						第1张		共1张	
批准	徐君辉				Dimensions are shown:mm(inches)		温州康宏电子有限公司			
					2026. 02. 08		http://www.khan.cn			

温州康宏电子有限公司

产品名称
Product name:
产品型号
Model No:

客户名称
Customer:
制造批号
Lot No:

测试日期
Test Date:
测试人员
Tester:

NO 1-1			NO 1-2			NO 1-3			NO 1-4			NO 1-5		
	g	mm		g	mm		g	mm		g	mm		g	mm
CP	270.70	0.29	CP	282.87	0.28	CP	269.40	0.29	CP	285.27	0.31	CP	294.23	0.35
CL	154.98	0.32	CL	163.00	0.31	CL	160.27	0.31	CL	168.33	0.34	CL	193.52	0.37
CP-CL	115.72	43%	CP-CL	119.87	42%	CP-CL	109.13	41%	CP-CL	116.94	41%	CP-CL	100.71	34%
CP-RL	175.90	65%	CP-RL	181.76	64%	CP-RL	174.80	65%	CP-RL	181.88	64%	CP-RL	172.61	59%
RP	194.17	0.25	RP	199.62	0.23	RP	190.54	0.24	RP	199.45	0.26	RP	210.49	0.29
RL	94.80	0.27	RL	101.11	0.25	RL	94.60	0.26	RL	103.39	0.28	RL	121.62	0.30
SWon	1.15	0.00	SWon	1.35	0.00	SWon	1.01	0.00	SWon	1.01	0.00	SWon	1.67	0.00
SWoff	0.00	0.00	SWoff	0.00	0.00	SWoff	0.00	0.00	SWoff	0.00	0.00	SWoff	0.00	0.00
R	5005.00	0.00	R	5005.00	0.00	R	5005.00	0.00	R	5005.00	0.00	R	5005.00	0.00

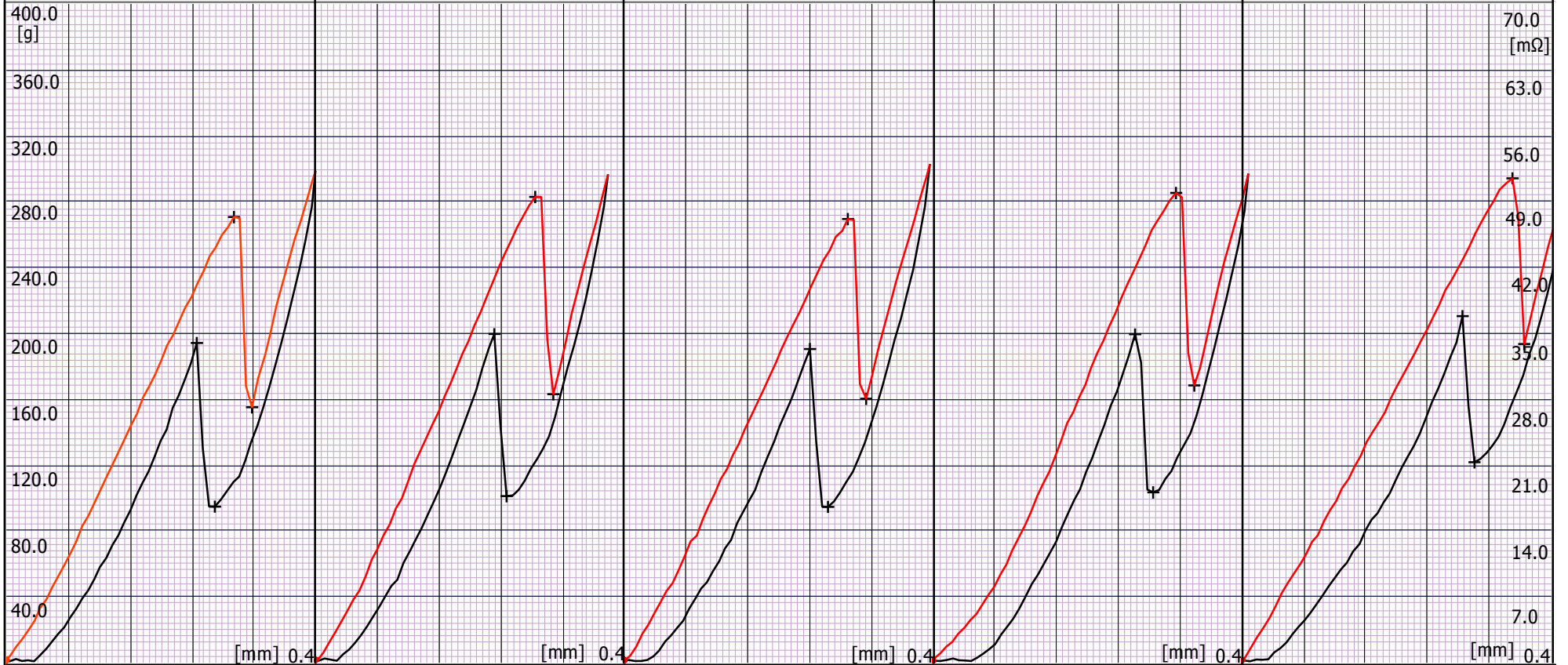

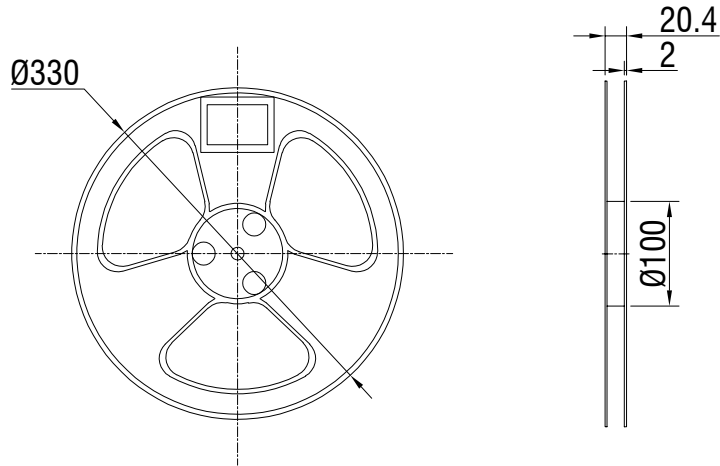
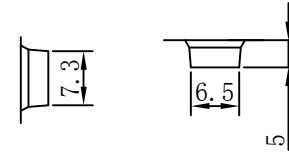
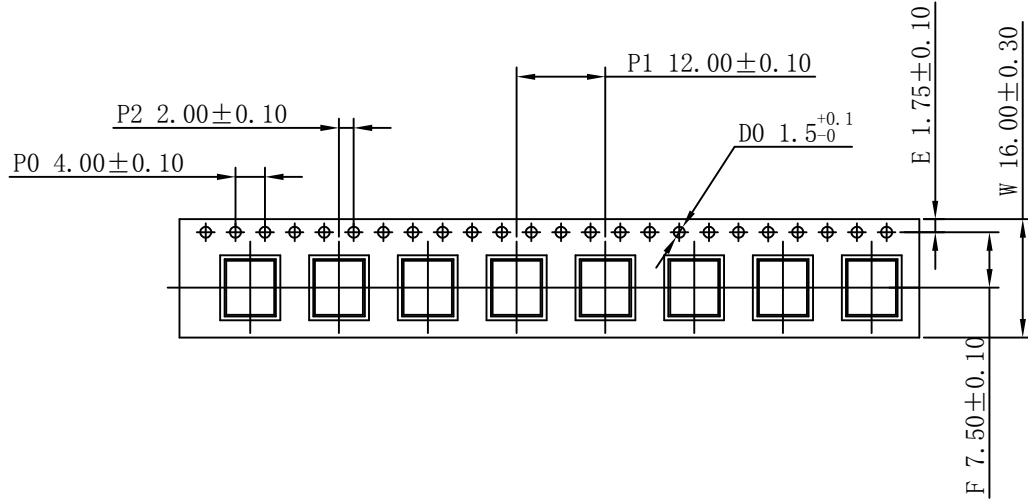

说明:

1. 10个边孔的累计公差不能超过±0.2mm.
2. 材料规格: PS 透明抗静电, 厚度 0.35mm.
3. 每卷包装数量:1000PCS.
4. 载带在250mm长度以内最大弯曲度不超过1mm (见下图).

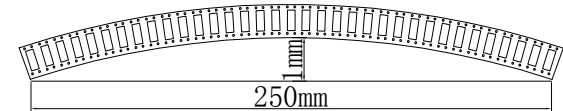

借通用件登记

描图

校描

旧底图总号

签字

日期

					轻触开关		TSR06631-050D531KD-R1000				
标记	处数	更改文件号	签名	日期			阶段	标记	质量	比例	版本
设计	余嘉诚				视图		1:1				
审核	朱树清						第1张		共1张		
批准	徐君辉				2026. 02. 08		温州康宏电子有限公司				

