

1. Description

The RCLAMP3324P.TCT(ES) is Transient Voltage Suppressor that designed to protect components which are connected to data and transmission lines against electrostatic discharge (ESD), electrical fast transient (EFT), and lightning. All pins are rated to withstand 20kV ESD pulses using the IEC61000-4-2 air discharge method.

2. Features

- IEC 61000-4-2 Level 4 ESD Protection
 - ±20kV Contact Discharge
 - ±20kV Air Discharge
- 40W Peak pulse Power (8/20us)
- Low clamping voltage
- Working voltage: 3.3V
- Low leakage current
- RoHS compliant
- Protecting 4 unidirectional lines
- Ultra Low Junction capacitance: 0.45pF Typ. (IO-GND)

3. Applications

- USB & HDMI Interfaces
- Portable electronics
- Servers, notebooks, and desktop PCs
- Set-top box
- Communication systems
- PoE

4. Ordering Information

Part Number	Package	Marking	Material	Packing	Quantity per reel	Flammability Rating	Reel Size
RCLAMP3324P.TCT(ES)	DFN2510-10L	.3V4UB	Halogen free	Tape & Reel	3,000 PCS	UL 94V-0	7inches

Table-1 Ordering information

5. Pin Configuration and Functions

Pin	Name	Description	Outline	Circuit Diagram
1,2,4,5	IO	Connect to IO	Note1 	
3,8	GND	Connect to GND		
Others	NC	No Connection		

Table-2 Pin configuration

Note1:

This diagram is only an electrical schematic, and the actual pin size is based on POD.

6. Specification

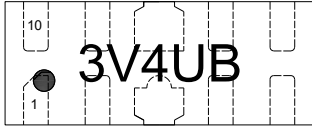
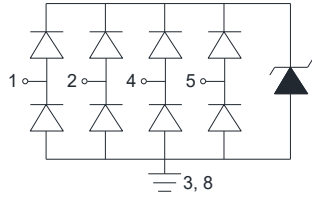
6.1. Absolute Maximum rating

Over operating free-air temperature range (unless otherwise noted)

Parameters	Symbol	Min.	Max.	Unit
Peak pulse power (tp=8/20us)@25°C	P _{pk}	-	40	W
Peak pulse current (tp=8/20us)@25°C	I _{PP}		8	A
ESD (IEC61000-4-2 air discharge) @25°C	V _{ESD}	-	±20	kV
ESD (IEC61000-4-2 contact discharge) @25°C	V _{ESD}	-	±20	kV
Junction temperature	T _J	-	150	°C
Operating temperature	T _{OP}	-40	125	°C
Storage temperature	T _{STG}	-55	150	°C
Lead temperature	T _L	-	260	°C

Table-3 Absolute Maximum rating

6.2. Electrical Characteristics

At TA = 25°C unless otherwise noted

Parameter	Symbol	Conditions	Min.	Typ.	Max.	Units
Reverse Stand-off Voltage	V_{RWM}			3.3	5.0	V
Reverse Breakdown Voltage	V_{BR}	$I_T=1mA$	5.0	7.3		V
Reverse Leakage Current	I_R	$V_{RWM}=3.3V$			100	nA
Clamping Voltage	V_{CL}	$I_{PP}=1A; t_p=8/20\mu s$		1.0	3.0	V
Clamping Voltage	V_{CL}	$I_{PP}=8A; t_p=8/20\mu s$		3.5	5.0	V
Dynamic Resistance	R_{dyn}	$I_R= 16A; T_{amb} = 25^\circ C$		0.2		Ω
Junction Capacitance	C_J	$V_R=0V; f=1MHz; IO-GND$		0.45	0.50	pF
		$V_R=1.5V; f=1MHz; IO-GND$		0.35	0.40	
		$V_R=2.5V; f=1MHz; IO-GND$		0.32	0.38	
		$V_R=0V; f=1MHz; IO-IO$		0.22	0.25	

Table-4 Electrical Characteristics

Symbol	Parameters
V_{RWM}	Reverse stand-off voltage
I_R	Reverse leakage current
V_{BR}	Reverse breakdown voltage
I_{BR}	Reverse breakdown current
V_{CL}	Clamping voltage
V_{TRIG}	Reverse trigger voltage
I_{TRIG}	Reverse trigger current
V_{HOLD}	Reverse holding voltage
I_{HOLD}	Reverse holding current
I_{PP}	Peak pulse current

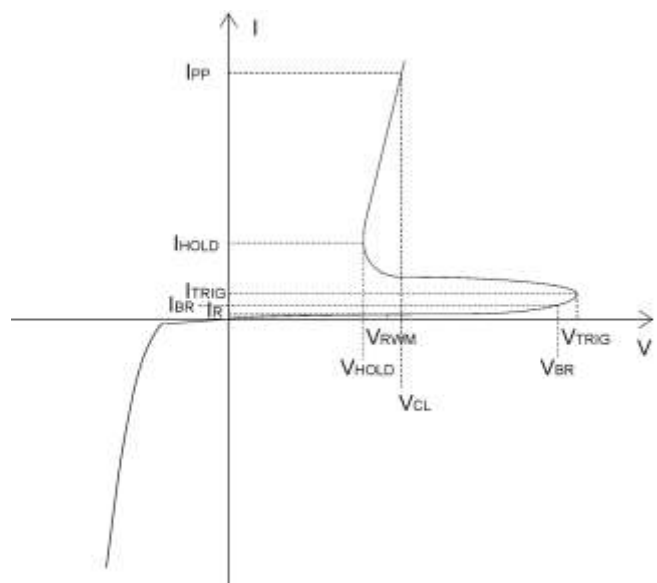

7. Typical Characteristic

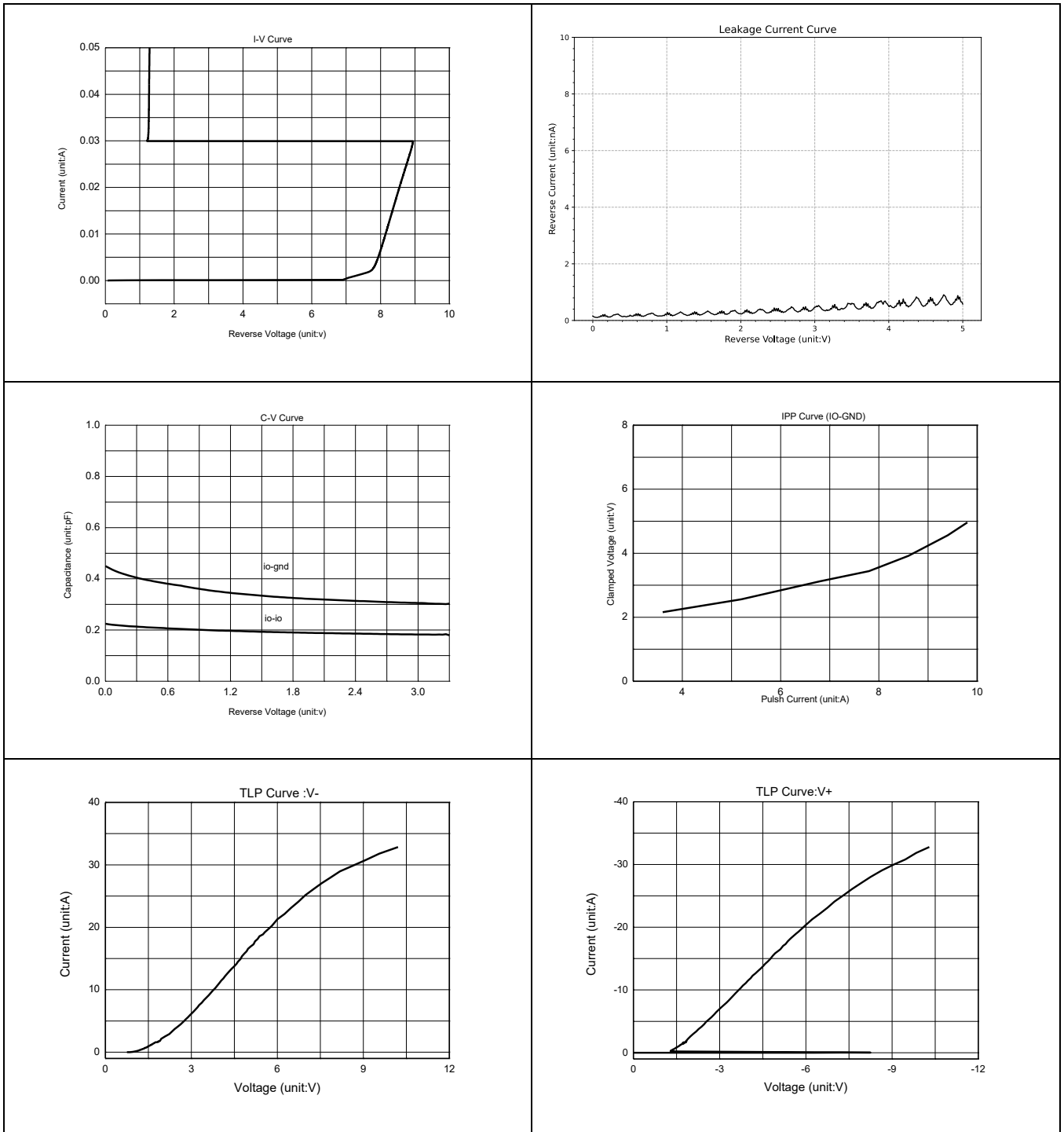

Measurement Wave According to IEC Standard

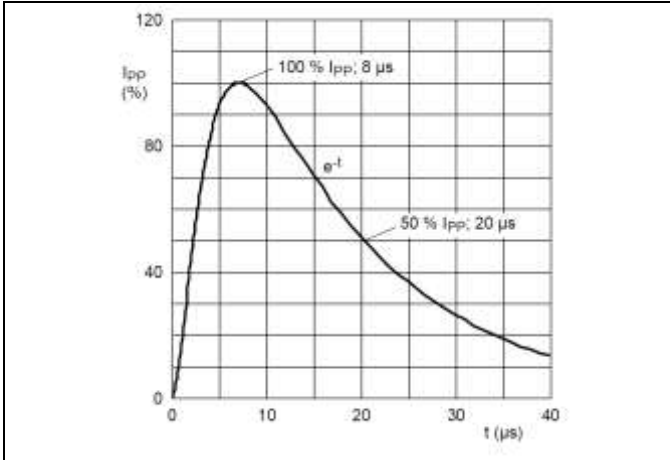

8/20 μ s pulse waveform according to IEC 61000-4-5

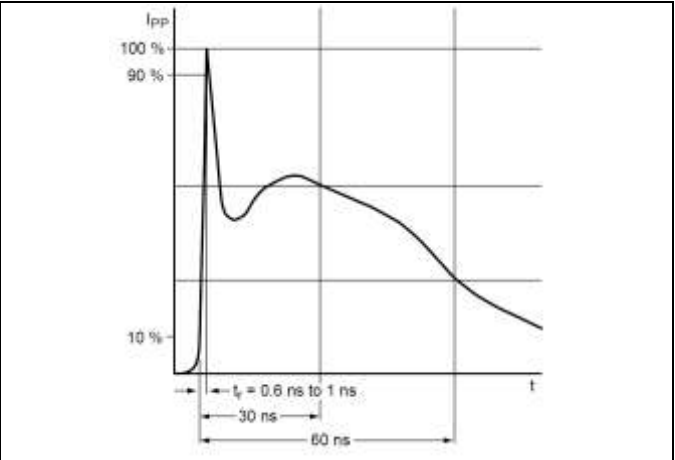

ESD pulse waveform according to IEC 61000-4-2

HDMI2.1 Eye Pattern 12Gbps

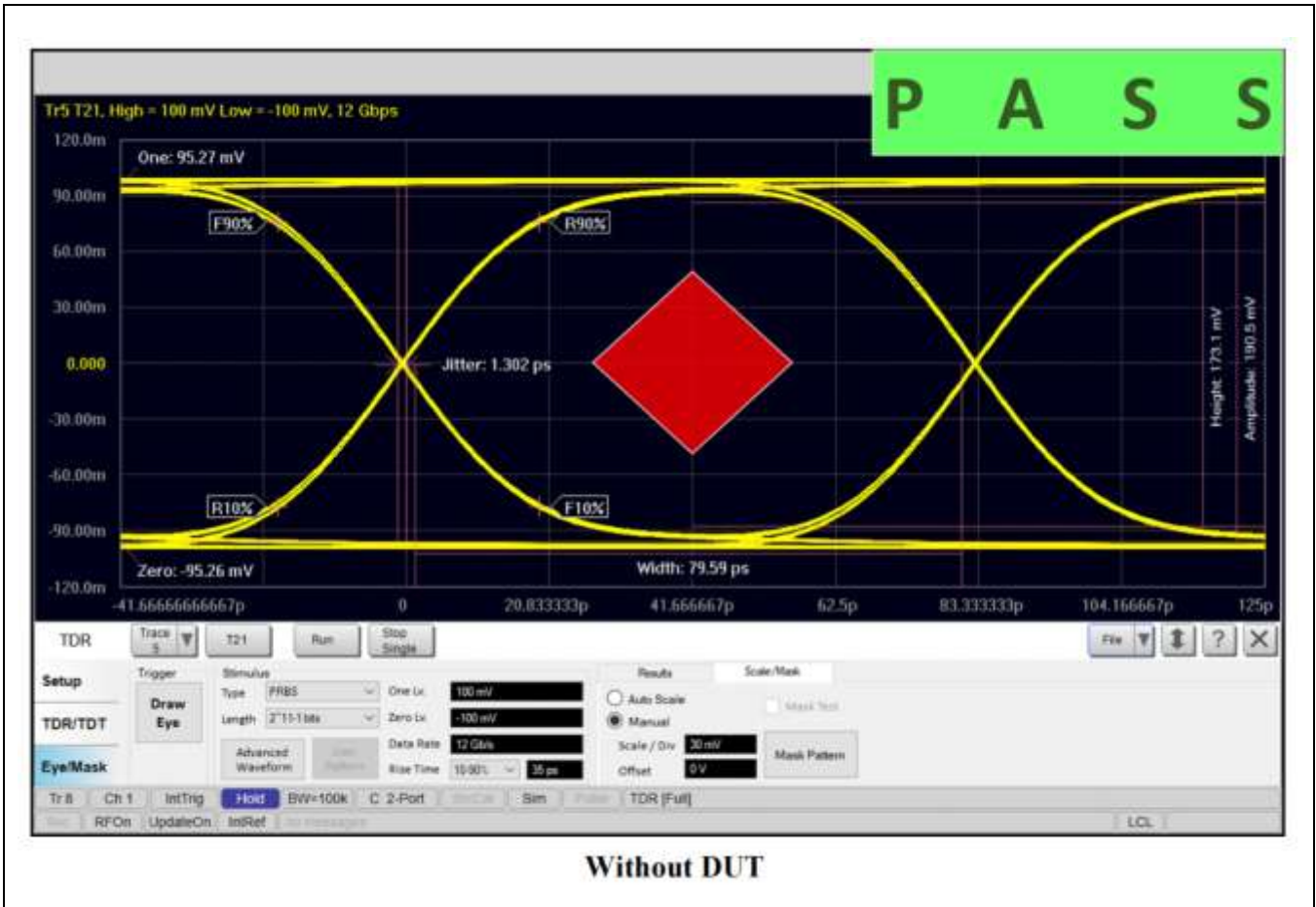

Without DUT

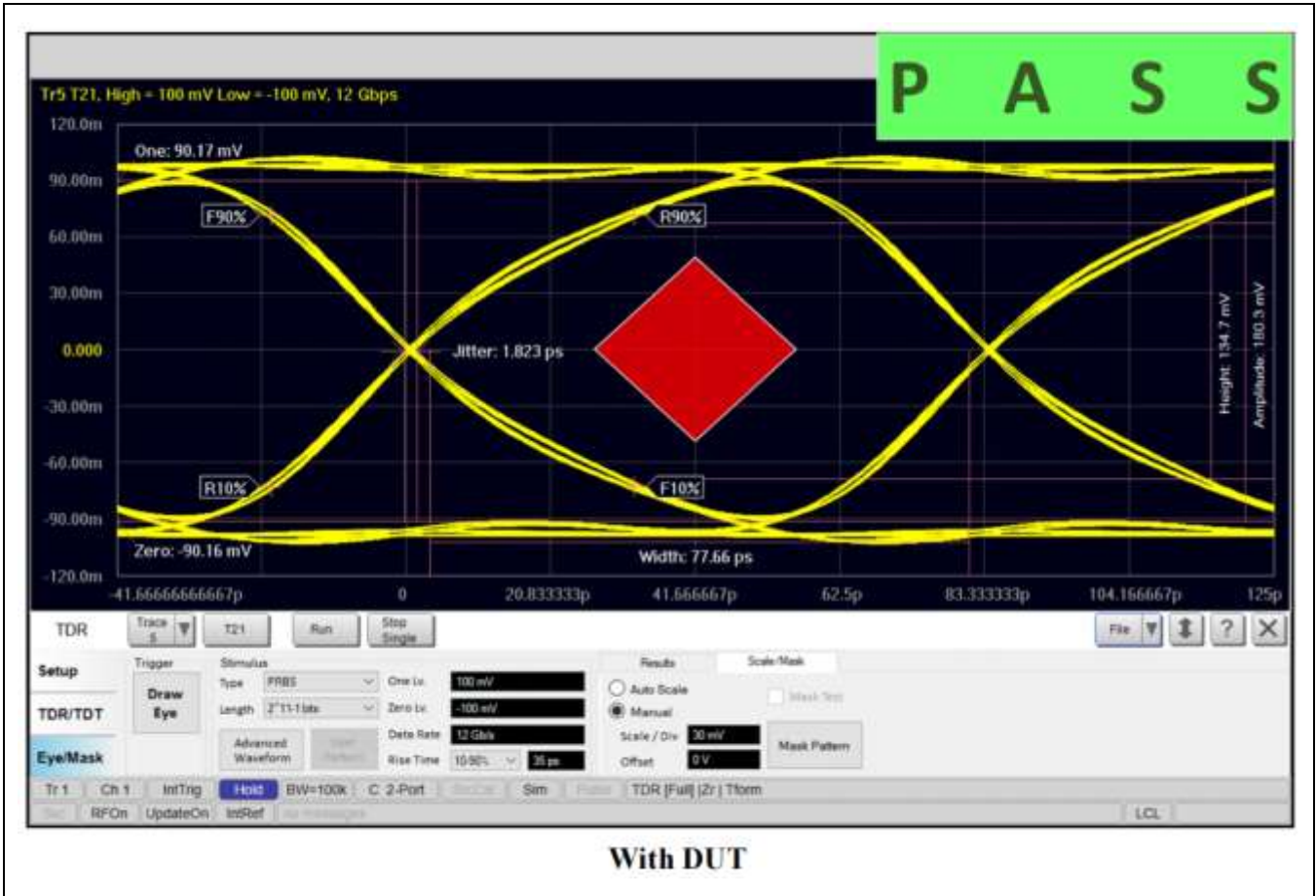

8. Dimension (DFN2510-10L)

POD A(C)

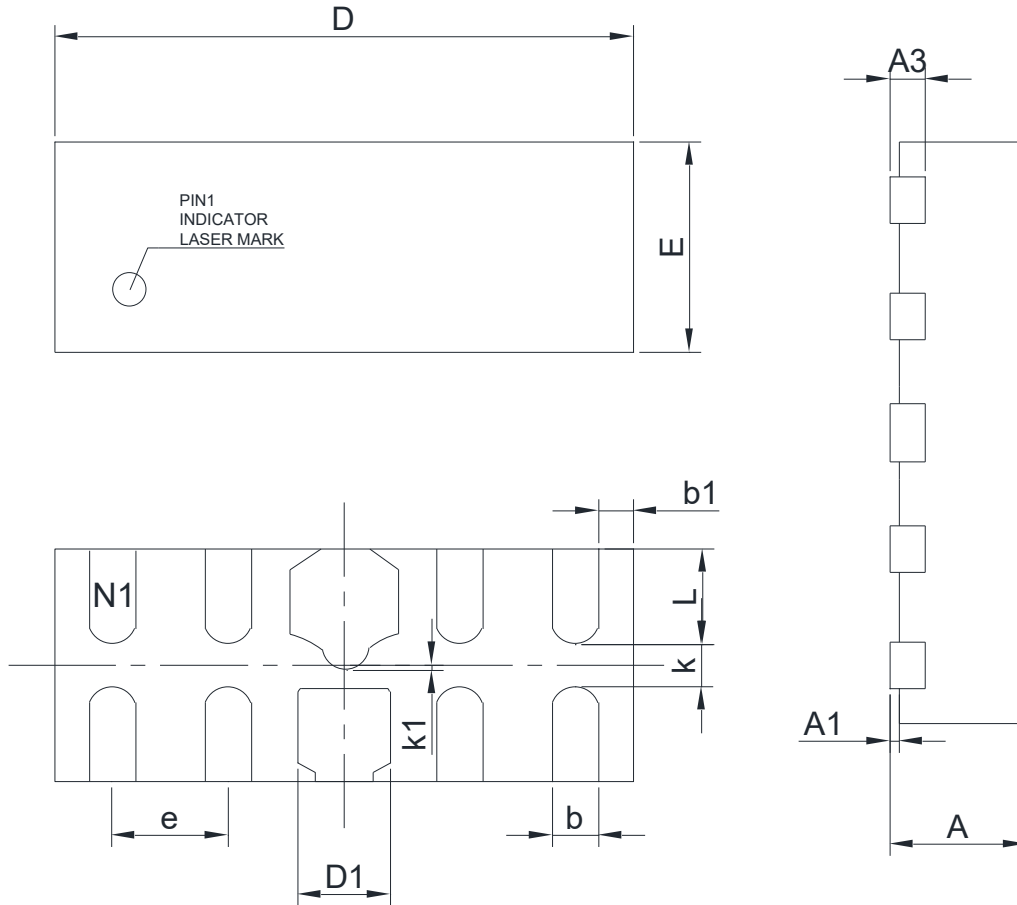

Dimensions in Millimeter							
Symbol	Min.	Nom.	Max.	Symbol	Min.	Nom.	Max.
A	0.450	0.500	0.550	D	2.450	2.500	2.550
A1	0.000	0.025	0.050	E	0.950	1.000	1.050
A3	0.110 REF			e	0.500 TYP		
b	0.180	0.220	0.260	k1	0.060	0.080	0.100
b1	0.100	0.150	0.200	L	0.350	0.400	0.450
D1	0.350	0.400	0.450	K	0.210	0.220	0.230

POD B(A)

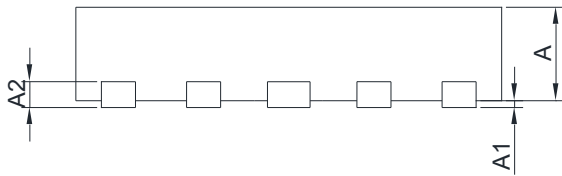
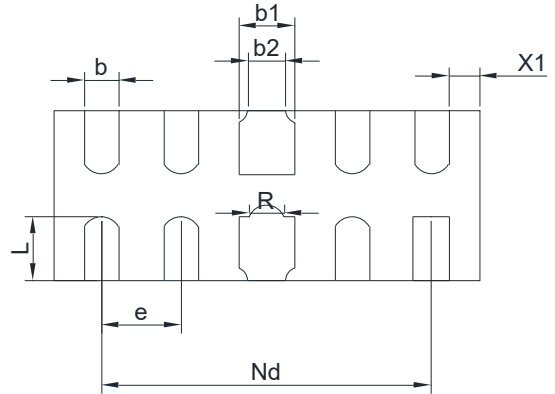
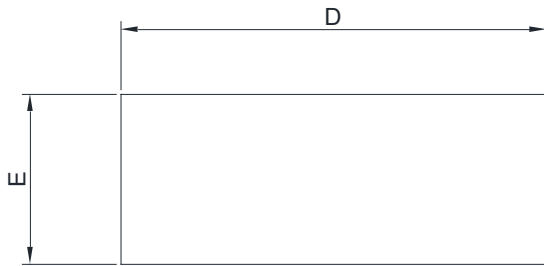

Dimensions in Millimeter(mm)					
SYMBOL	MIN	MAX	SYMBOL	MIN	MAX
A	0.50	0.60	b2	0.20REF	
A1	0.00	0.05	D	2.45	2.55
A2	0.15REF		E	0.95	1.05
b	0.15	0.25	L	0.33	0.43
b1	0.35	0.45	e	0.50BSC	
Nd	2.00BSC		X1	0.08	0.22

9. Recommended Soldering Footprint

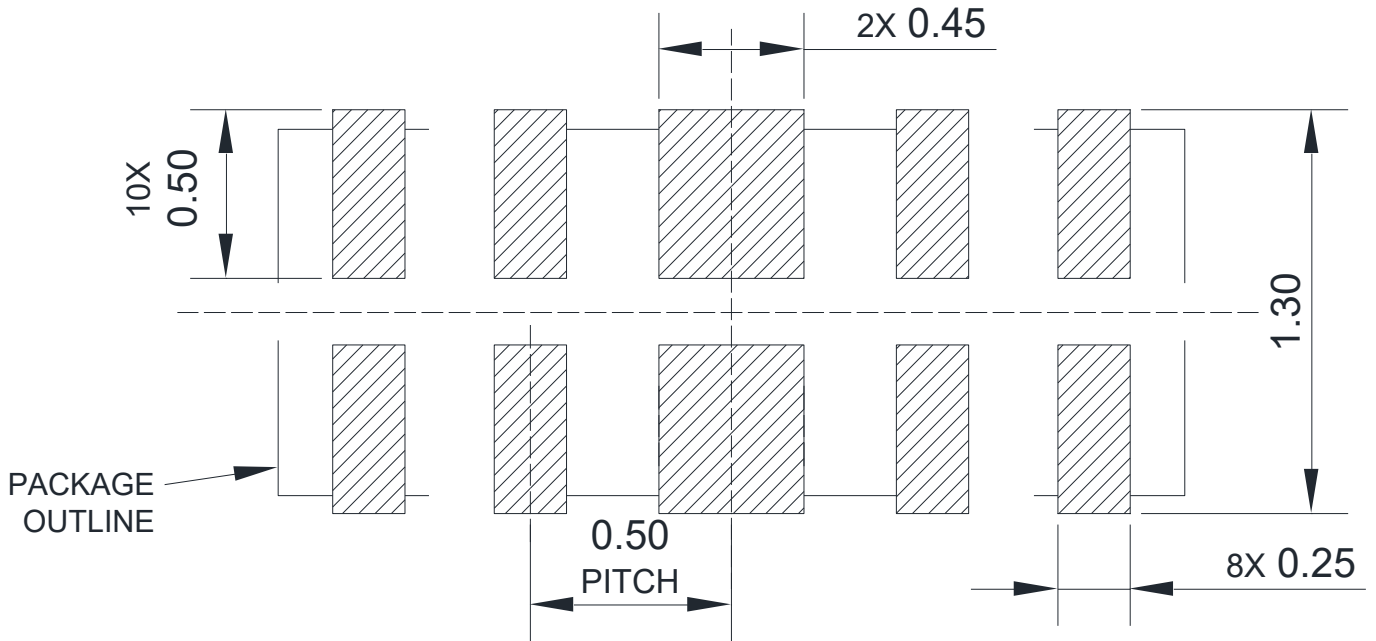

DIMENSIONS: MILLIMETERS

DISCLAIMER

ELECSUPER PROVIDES TECHNICAL AND RELIABILITY DATA (INCLUDING DATASHEETS), DESIGN RESOURCES (INCLUDING REFERENCE DESIGNS), APPLICATION OR OTHER DESIGN ADVICE, SAFETY INFORMATION, AND OTHER RESOURCES “AS IS” AND WITH ALL FAULTS, AND DISCLAIMS ALL WARRANTIES, EXPRESS AND IMPLIED, INCLUDING WITHOUT LIMITATION ANY IMPLIED WARRANTIES OF MERCHANTABILITY, FITNESS FOR A PARTICULAR PURPOSE OR NON-INFRINGEMENT OF THIRD PARTY INTELLECTUAL PROPERTY RIGHTS.

These resources are intended for skilled developers designing with ElecSuper products. You are solely responsible for

- (1) selecting the appropriate ElecSuper products for your application;
- (2) designing, validating and testing your application;
- (3) ensuring your application meets applicable standards, and any other safety, security, or other requirements.

These resources are subject to change without notice. ElecSuper grants you permission to use these resources only for development of an application that uses the ElecSuper products described in the resource. Other reproduction and display of these resources are prohibited. No license is granted to any other ElecSuper intellectual property right or to any third party intellectual property right. ElecSuper disclaims responsibility for, and you will fully indemnify ElecSuper and its representatives against, any claims, damages, costs, losses, and liabilities arising out of your use of these resources. ElecSuper's products are provided subject to ElecSuper's Terms of Sale or other applicable terms available either on www.elecsuper.com or provided in conjunction with such ElecSuper products. ElecSuper's provision of these resources does not expand or otherwise alter ElecSuper's applicable warranties or warranty disclaimers for ElecSuper products.