

MSKSEMI 美森科

SEMICONDUCTOR



ESD



TVS



TSS



MOV



GDT



PLED

SN74LVC1G06xxxx-MS

Product specification

Description



This single inverter buffer and driver is designed for 1.65-V to 5.5-V VCC operation.

The output of the SN74LVC1G06xxxx-MS device is open drain and can be connected to other open-drain outputs to implement active-low wired-OR or active high wired-AND functions. The maximum sink current is 32 mA.

Features

- Supports 5V V_{CC} operation
- Input and Open-Drain Output accept voltages to 5.5V
- Low power consumption, 10µA max I_{CC}
- ±24mA output drive at 3.3V for open-drain devices
- I_{off} supports partial-power-down mode Operation and Back-Drive Protection

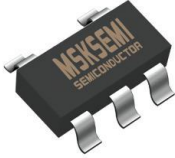
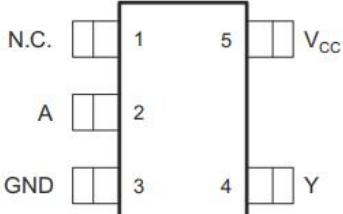
DEVICE SUMMARY, PIN AND PACKAGES

| SOT-23-5 | PIN DESCRIPTION | MARKING |
|--|--|--|
|  |  |  |

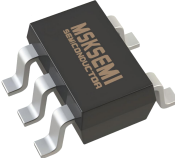
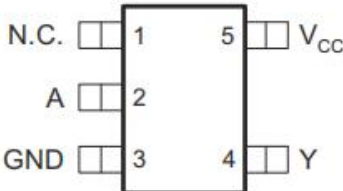
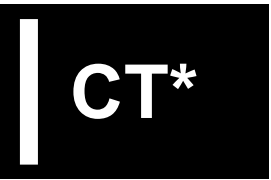
| SC70-5 | PIN DESCRIPTION | MARKING |
|---|---|---|
|  |  |  |

| PIN No. | NAME | I/O | FUNCTION |
|---------|------|-----|----------------|
| DBV/DCK | | | |
| 1 | NC | | No Connected |
| 2 | A | I | Input |
| 3 | GND | | Ground |
| 4 | Y | O | Output |
| 5 | VCC | | Supply Voltage |

ORDER INFORMATION

| ORDERING NUMBER | PACKAGE | PACKING OPTION |
|--------------------|---------|----------------|
| SN74LVC1G06DBVR-MS | SOT23-5 | 3000PCS |
| SN74LVC1G06DCKR-MS | SC70-5 | 3000PCS |

Logic Diagram

Figure 3.1: SN74LVC1G06xxxx-MS Logic Diagram

Function Table

| Input | Output |
|-------|--------|
| A | Y |
| 1 | 0 |
| 0 | Hi-Z |

1=High State, 0=Low State

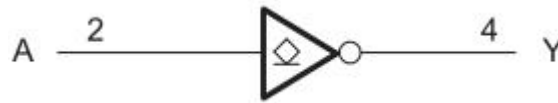
Absolute Maximum Ratings

| Symbol | Parameter | MIN | MAX | Unit |
|-----------------|--|------|-----------------------|------|
| V _{CC} | Supply Voltage | -0.5 | 6.5 | V |
| V _I | Input Voltage Range | -0.5 | 6.5 | V |
| V _O | Voltage Range(applied to any output in the high-impedance or power-off state) ⁽¹⁾ | -0.5 | 6.5 | V |
| | Voltage Range(applied to any output in the high or low state) | -0.5 | V _{CC} + 0.5 | V |
| I _O | Continuous Output Current | | ±50 | mA |
| T _J | Junction Temperature | | 125 | °C |
| T _{OP} | Operating Temperature | 0 | 70 | °C |

Absolute maximum ratings are those values beyond which the device could be permanently damaged. These are stress ratings only, which do not imply functional operation of the device at these or any other conditions beyond those indicated under normal operating conditions.

(1) The input and output negative-voltage ratings may be exceeded if the input and output current ratings are observed.

Electrical Characteristics

DC Specifications

(T_a=25°C, voltages are referenced to GND (ground=0V), All typical values are at V_{CC}=3.3V, unless otherwise specified)

| Symbol | Parameter | Test Condition | MIN | TYP | MAX | Unit |
|-----------------|--------------------------|---------------------------------|---------------------|-----|---------------------|------|
| V _{IH} | High Level Input Voltage | V _{CC} =1.65V to 1.95V | 0.65V _{CC} | -- | -- | V |
| | | V _{CC} =2.3V to 2.7V | 1.7 | -- | -- | V |
| | | V _{CC} =2V to 5.5V | 0.7V _{CC} | -- | -- | V |
| V _{IL} | Low Level Input Voltage | V _{CC} =1.65V to 1.95V | -- | -- | 0.35V _{CC} | V |
| | | V _{CC} =2.3V to 2.7V | -- | -- | 0.7 | V |
| | | V _{CC} =3V to 3.6V | -- | -- | 0.8 | V |
| | | V _{CC} =4.5V to 5.5V | -- | -- | 0.3V _{CC} | V |
| I _{OL} | Low Level Output Current | V _{CC} =1.65V | -- | -- | 4 | mA |
| | | V _{CC} =2.3V | -- | -- | 8 | mA |
| | | V _{CC} =3V | -- | -- | 16 | mA |
| | | | -- | -- | 24 | mA |
| | | V _{CC} =4.5V | -- | -- | 32 | mA |

| Symbol | Parameter | Test Condition | MIN | TYP | MAX | Unit |
|-----------------|---|--|-----|------|----------|---------|
| V_{OL} | Low Level Output Voltage | $V_{CC}=1.65V$ to $5.5V, I_{OL}=100\mu A$ | -- | -- | 0.1 | V |
| | | $V_{CC}=1.65V, I_{OL}=4mA$ | -- | 0.09 | -- | V |
| | | $V_{CC}=2.3V, I_{OL}=8mA$ | -- | 0.1 | -- | V |
| | | $V_{CC}=3V, I_{OL}=16mA$ | -- | 0.15 | -- | V |
| | | $V_{CC}=3V, I_{OL}=24mA$ | -- | 0.25 | -- | V |
| | | $V_{CC}=4.5V, I_{OL}=32mA$ | -- | 0.25 | -- | V |
| I_i | A Input Leakage Current | $V_{CC}=0$ to $5.5V, V_i=V_{CC}$ or GND | -- | 0 | ± 1 | μA |
| I_{off} | Power Off Leakage Current | $V_{CC}=0V, V_i$ or $V_o=5.5V$ | -- | 0 | ± 10 | μA |
| I_{CC} | Quiescent Supply Current | $V_{CC}=1.65V$ to $5.5V, V_i=V_{CC}$ or GND, $I_o=0$ | -- | 0 | 10 | μA |
| ΔI_{CC} | Additional Quiescent Supply Current Per Input Pin | $V_{CC}=3V$ to $5.5V$, one input at $V_{CC}-0.6V$, other inputs at V_{CC} or GND | -- | -- | 500 | μA |

Application Information

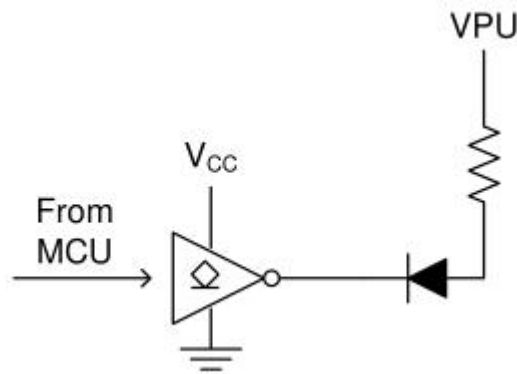
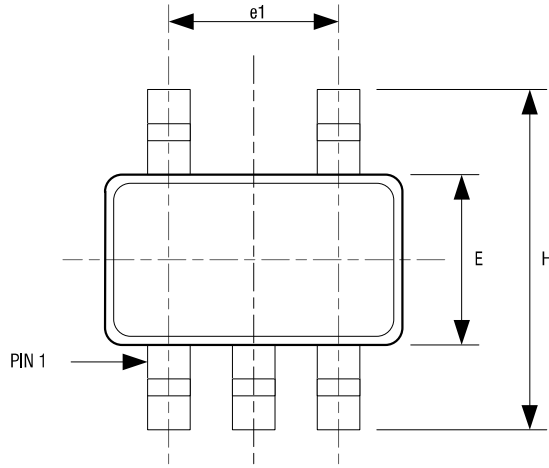

Figure 5.1: Application Schematic

PACKAGE DESCRIPTION

SOT-23-5



5LD SOT-23 PACKAGE OUTLINE DIMENSIONS

| Dimension | Min. | Max. |
|-----------|-----------|------|
| A | 1.05 | 1.35 |
| A1 | 0.04 | .15 |
| B | 0.3 | 0.5 |
| C | 0.09 | 0.2 |
| D | 2.8 | 3.0 |
| H | 2.5 | 3.1 |
| E | 1.5 | 1.7 |
| e | 0.95 REF. | |
| e1 | 1.90 REF. | |
| L1 | 0.2 | 0.55 |
| L | 0.35 | 0.8 |
| Q | 0° | 10° |

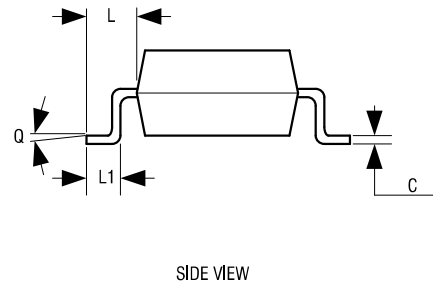
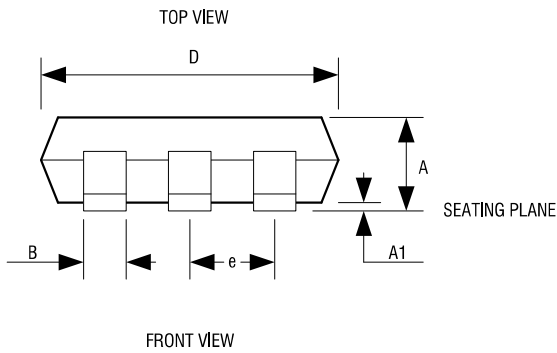

NOTE:

1. DIMENSIONS ARE IN MILLIMETERS
2. DRAWING NOT TO SCALE
3. DIMENSIONS ARE INCLUSIVE OF PLATING
4. DIMENSIONS ARE EXCLUSIVE OF MOLD FLASH AND METAL BURR

SC70-5

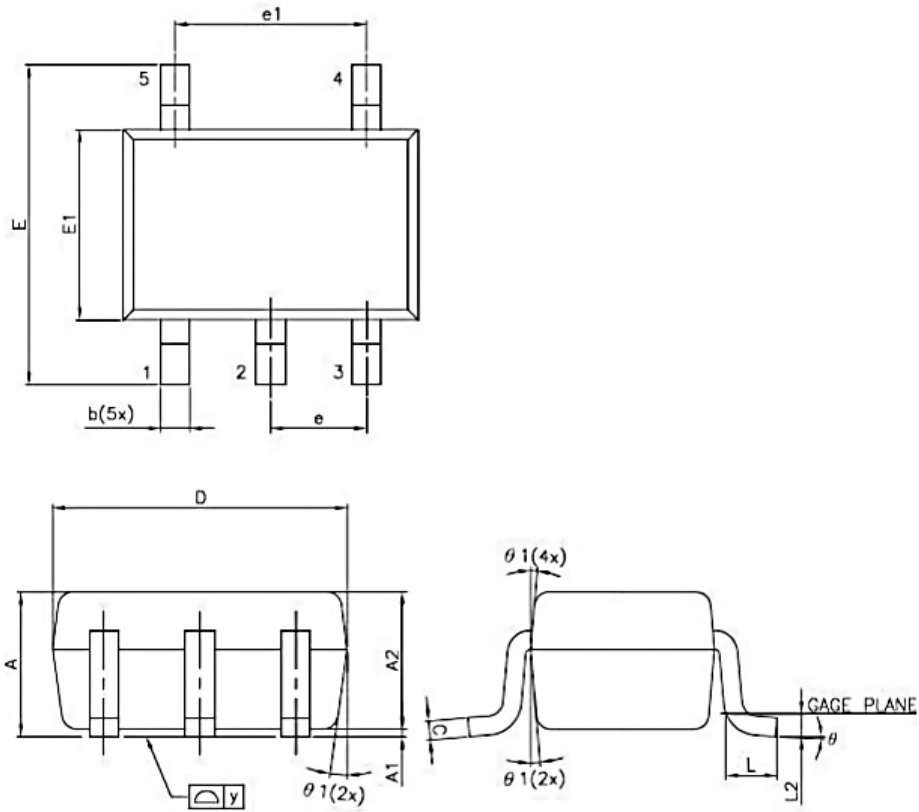

| Symbol | Dim in mm | | |
|--------|-----------|------|------|
| | MIN | TYP | MAX |
| A | 0.90 | 1.00 | 1.10 |
| A1 | 0.00 | 0.05 | 0.10 |
| A2 | 0.90 | 0.95 | 1.00 |
| b | 0.15 | 0.25 | 0.35 |
| C | 0.10 | 0.12 | 0.15 |
| D | 1.80 | 2.00 | 2.20 |
| E | 2.15 | 2.25 | 2.35 |
| E1 | 1.15 | 1.25 | 1.35 |
| e | 0.650TYP. | | |
| e1 | 1.20 | 1.30 | 1.40 |
| L | 0.25 | 0.30 | 0.40 |
| L2 | 0.15TYP. | | |
| Y | 0.00 | 0.05 | 0.10 |
| θ | 4° | 8° | 12° |

Attention

- Any and all MSKSEMI Semiconductor products described or contained herein do not have specifications that can handle applications that require extremely high levels of reliability, such as life-support systems, aircraft's control systems, or other applications whose failure can be reasonably expected to result in serious physical and/or material damage. Consult with your MSKSEMI Semiconductor representative nearest you before using any MSKSEMI Semiconductor products described or contained herein in such applications.
- MSKSEMI Semiconductor assumes no responsibility for equipment failures that result from using products at values that exceed, even momentarily, rated values (such as maximum ratings, operating condition ranges, or other parameters) listed in products specifications of any and all MSKSEMI Semiconductor products described or contained herein.
- Specifications of any and all MSKSEMI Semiconductor products described or contained herein stipulate the performance, characteristics, and functions of the described products in the independent state, and are not guarantees of the performance, characteristics, and functions of the described products as mounted in the customer's products or equipment. To verify symptoms and states that cannot be evaluated in an independent device, the customer should always evaluate and test devices mounted in the customer's products or equipment.
- MSKSEMI Semiconductor strives to supply high-quality high-reliability products. However, any and all semiconductor products fail with some probability. It is possible that these probabilistic failures could give rise to accidents or events that could endanger human lives, that could give rise to smoke or fire, or that could cause damage to other property. When designing equipment, adopt safety measures so that these kinds of accidents or events cannot occur. Such measures include but are not limited to protective circuits and error prevention circuits for safe design, redundant design, and structural design.
- In the event that any or all MSKSEMI Semiconductor products (including technical data, services) described or contained herein are controlled under any of applicable local export control laws and regulations, such products must not be exported without obtaining the export license from the authorities concerned in accordance with the above law.
- No part of this publication may be reproduced or transmitted in any form or by any means, electronic or mechanical, including photocopying and recording, or any information storage or retrieval system, or otherwise, without the prior written permission of MSKSEMI Semiconductor.
- Information (including circuit diagrams and circuit parameters) herein is for example only ; it is not guaranteed for volume production. MSKSEMI Semiconductor believes information herein is accurate and reliable, but no guarantees are made or implied regarding its use or any infringement of intellectual property rights or other rights of third parties.
- Any and all information described or contained herein are subject to change without notice due to product/technology improvement, etc. When designing equipment, refer to the "Delivery Specification" for the MSKSEMI Semiconductor product that you intend to use.