

修订 REV	标记 MARK	修改摘要 REVISION DESCRIPTION	签名 SIGNATURE	日期 DATE
AO		NEW RELEASE	黄艳兰	2021-07-19

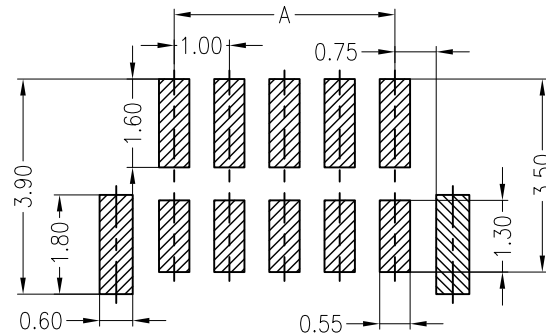
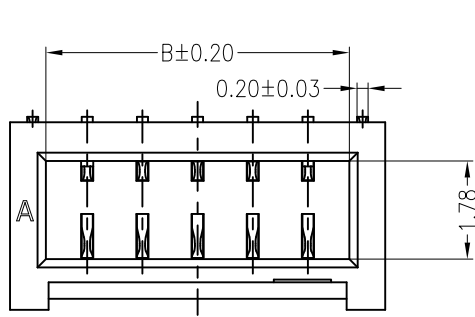

PCB LAYOUT(Tolerance:±0.05)

Specifications:

- Poles: 02 to 20
- Contact resistance: ≤20mΩ
- Insulation resistance: ≥100MΩ
- Rated voltage: 125V AC DC
- Rated current: 1.0A AC DC
- Withstand Voltage: 500V AC/minute
- Temperature Range: -25°C ~ +85°C
- Housing: PA6T UL94V-0, Natural
- Cap: PA6T UL94V-0, Natural
- Contacts: Phosphor Bronze/Matte Sn-plated
- Solder tabs: Phosphor Bronze/Matte Sn-plated

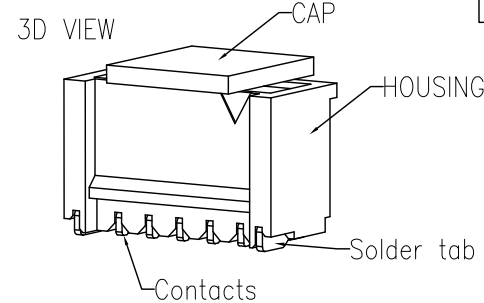
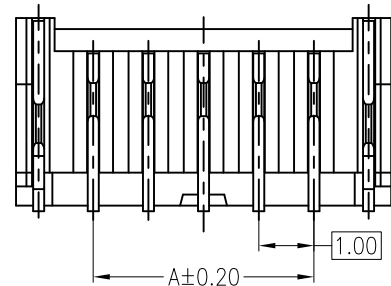
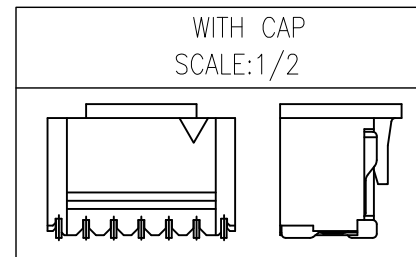
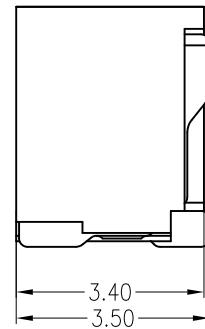
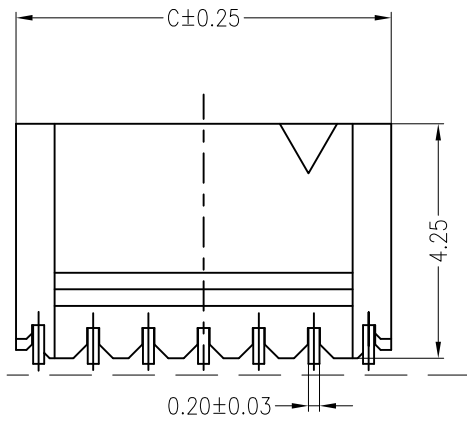

PIN	DIM A	DIM B	DIM C	PIN	DIM A	DIM B	DIM C
2P	1.00	2.50	3.80	12P	11.00	12.5	13.8
3P	2.00	3.50	4.80	*13P	12.00	13.5	14.8
4P	3.00	4.50	5.80	14P	13.00	14.5	15.8
5P	4.00	5.50	6.80	*15P	14.00	15.5	16.8
6P	5.00	6.50	7.80	*16P	15.00	16.5	17.8
*7P	6.00	7.50	8.80	*17P	16.00	17.5	18.8
8P	7.00	8.50	9.80	*18P	17.00	18.5	19.8
*9P	8.00	9.50	10.8	*19P	18.00	19.5	20.8
10P	9.00	10.50	11.8	*20P	19.00	20.5	21.8
*11P	10.00	11.50	12.8				



深圳市华德共创科技有限公司

Shenzhen Huade co-create Technology Co., LTD

TEL: 0755-27111216 FAX: 0755-29940187

-TOLERANCES- UNLESS OTHERWISE SPECIFIED 公差参数表						TITLE: 产品名称: NH1.0带扣立贴			
X.X	±0.30	X.X°	±3°	APPD: 核准:	谢亮	PART NO: 产品编号: HDGC1002WVB-S-XP			
X.XX	±0.30	X.XX°	±2°	CHECK: 校对:	王建业	DATE	SCALE	UNIT	CODE NUMBER
X.XXX	±0.10	X.XXX°	±1°	DRAW: 绘图:	黄艳兰	2021-07-19	1:1	mm	A018