

REV	MARK	修改摘要 REVISION DESCRIPTION	签名 SIGNATURE	日期 DATE
AO		NEW DRG		2016-03-12

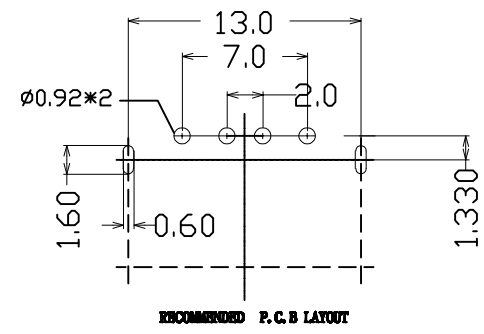
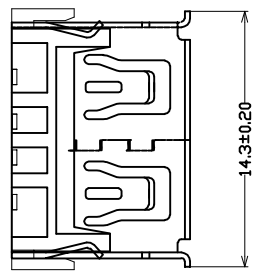
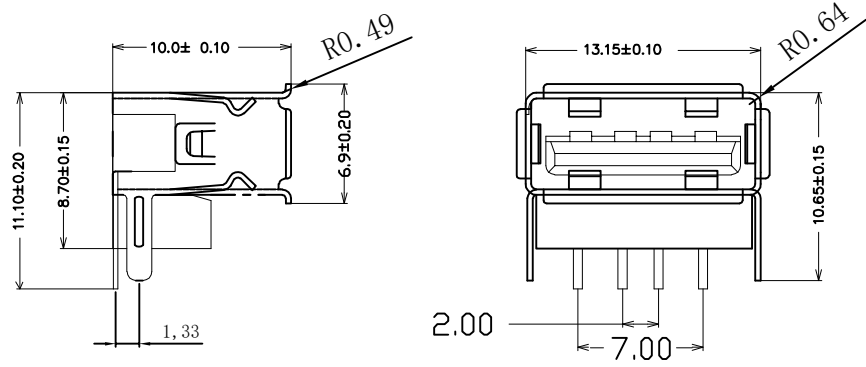

规格说明:Specifications:

电气特性:Electrical:

1. 额定电流: Current Rating
1.5A/contact terminal
2. 额定电压: Voltage Rating
30V DC
3. 接触阻抗: Contact Resistance
30 milliohms MAX
4. 耐电压: Dielectnic Withstanding Voitage:
500 V AC AT Sea Level
5. 绝缘阻抗: Lnsulation Resistance:
1000MEGA ohms MIN

物理性能:Mechanical:



1. 插拔力: Cnnector Mate and Unmate Force
Mate force:3.57kgf (MAX)
Unmate force:1.02kgf (MIN)
2. 端子保持力: Terminal Retenion
1.2kgf (MIN)

原材料:Matorial:

1. 塑胶:Housing:
Hing Temperature Thermaplastics,
U1 94V-0 PBT White/Black
2. 端子:Contact:Copper Alloy C2680
3. 外壳:Shell: SPCC

电镀:Finish:

1. 端子:Contact: Plated Gold in Mating Area;
Tin On Solder Talls
2. 外壳:Shell:
Nickel Plating

		深圳市华德共创科技有限公司 Shenzhen Huade co-create Technology Co.,LTD 电话: 0755-27111216 传真: 0755-29940187						
-TOLERANCES- UNLESS OTHERWISE SPECIFIED 公差参数表		 		TITLE: 产品名称: USB AF10.0后插后插卷边8.7黑胶反角				
X.X	±0.30	X.X*	±3°	APPD: 核准:	PART NO: 产品编号: USB-HXS-120DIP			
X.XX	±0.20	X.XX*	±2°	CHECK: 校对: 王建业	DATE	SCALE	UNIT	CODE NUMBER
X.XXX	±0.10	X.XXX*	±1°	DRAW: 绘图: 黄艳兰	2016-03-12	1:1	mm	A001

由 Autodesk 教育版产品制作

由 Autodesk 教育版产品制作