

修订 REV NO	标记 MARK	修改摘要 REVISION DESCRIPTION	签名 SIGNATURE	日期 DATE
		NEW DRG		2016-03-12

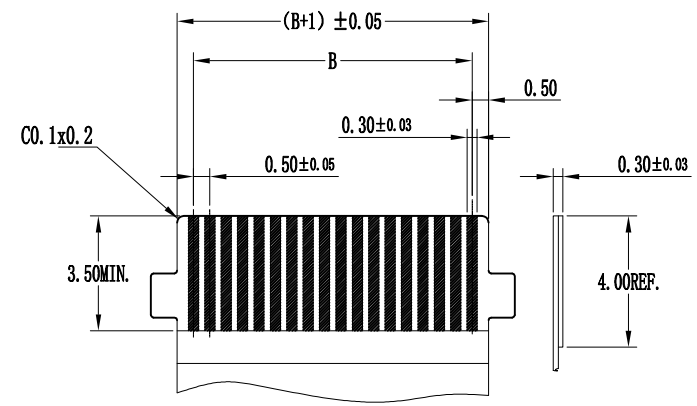

APPLICABLE FFC
TOLERANCE: ±0.05

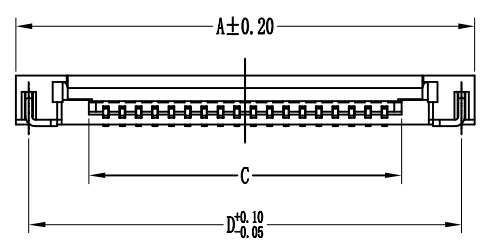
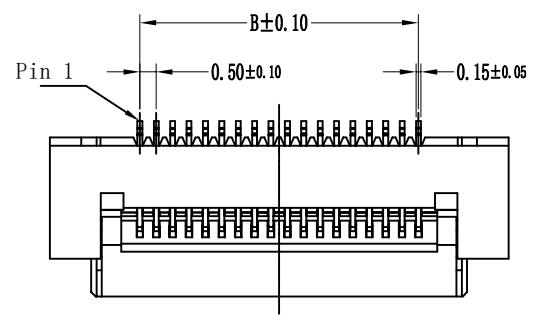
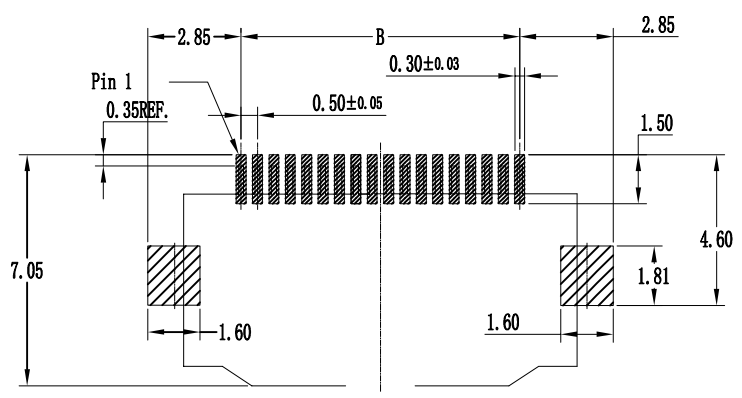
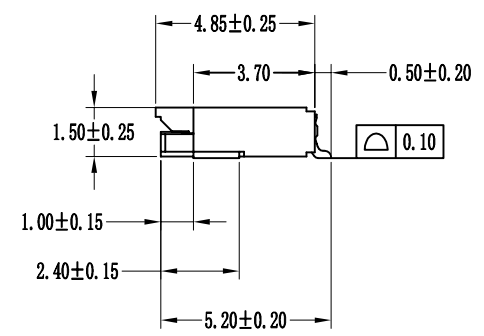

RECOMMEND PCB LAYOUT
TOLERANCE: ±0.05

- NOTES:
- MATERIAL:
HOUSING: HIGH-TEMP PLASTIC, UL 94-V0, COLOR: NATURE;
COVER: HIGH-TEMP PLASTIC, UL 94-V0, COLOR: BLACK;
CONTACT: Phosphor Bronze;
LEG: Brass;
 - PLATING:
CONTACT: Matte Tin.
LEG: TIN PLATED ON NICKEL OVERALL.
 - RATING:
CURRENT RATING: 0.5A AC/DC
VOLTAGE RATING: 25V AC/DC
TEMPERATURE RANGE: -25° C~+85° C;
 - PART NO:

Number of Contacts	Dimension			
	A	B	C	D
10	10.00	4.50	5.54	9.20
11	10.50	5.00	6.04	9.70
12	11.00	5.50	6.54	10.20
13	11.50	6.00	7.04	10.70
14	12.00	6.50	7.54	11.20
15	12.50	7.00	8.04	11.70
16	13.00	7.50	8.54	12.20
17	13.50	8.00	9.04	12.70
18	14.00	8.50	9.54	13.20
19	14.50	9.00	10.04	13.70
20	15.00	9.50	10.54	14.20
21	15.50	10.00	10.94	14.70
22	16.00	10.50	11.44	15.20
23	16.50	11.00	11.90	15.70
24	17.00	11.50	11.04	16.20
25	17.50	12.00	11.54	16.70



深圳市华德共创科技有限公司
Shenzhen Huade co-create Technology Co.,LTD
电话: 0755-27111216 传真: 0755-29940187

-TOLERANCES- UNLESS OTHERWISE SPECIFIED 公差参数表		TITLE: 产品名称: FPC 0.5间距1.5高带蝴蝶扣掀盖式	
X.X ±0.30	X.X* ±3°	APPD: 核准:	PART NO: 产品编号: 0.5K-1.5DK-nPWB
X.XX ±0.20	X.XX* ±2°	CHECK: 校对: 王建业	DATE SCALE UNIT CODE NUMBER
X.XXX ±0.10	X.XXX* ±1°	DRAW: 绘图: 黄艳兰	2016-03-12 1:1 mm A001