

修订 REV	标记 MARK	修改摘要 REVISION DESCRIPTION	签名 SIGNATURE	日期 DATE
AO		NEW RELEASE	黄艳兰	2016-08-16

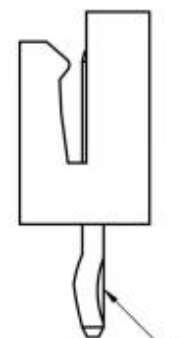

此处为打点样式
打点位置在最两边

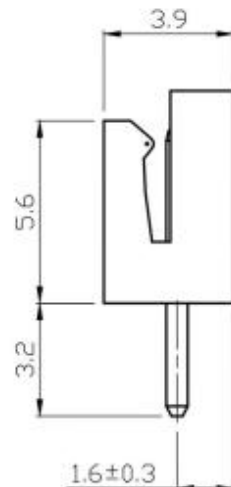
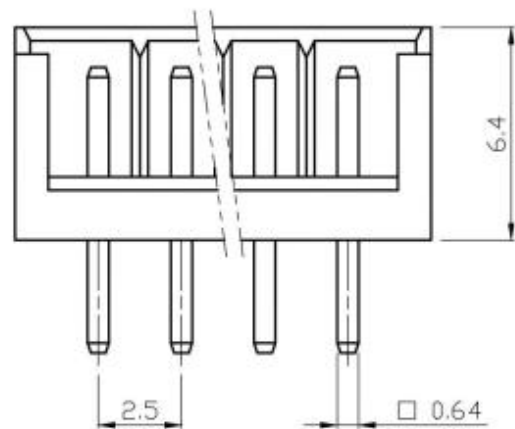
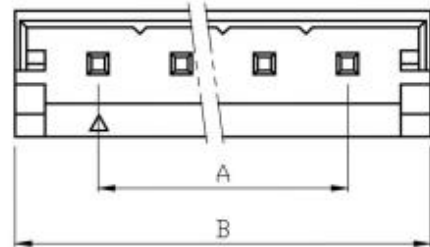
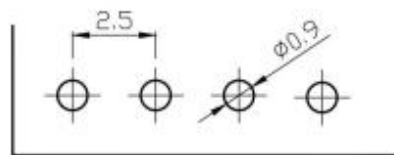

P. C. B LAYOUT

材质：
 塑胶：PA66
 PIN针：黄铜镀锡

线数 poles	PIN	尺寸 Dimensions(mm)	
		A	B
2	2P	2.50	7.50
3	3P	5.00	10.0
4	4P	7.50	12.5
5	5P	10.00	15.0
6	6P	12.50	17.5
7	7P	15.00	20.0
8	8P	17.50	22.5
9	9P	20.00	25.0
10	10P	22.50	27.5
11	11P	25.00	30.0
12	12P	27.50	32.5
13	13P	30.00	35.0
14	14P	32.50	37.5
15	15P	35.00	40.0
16	16P	37.50	42.5



深圳市华德共创科技有限公司

Shenzhen Huade co-create Technology Co.,LTD

TEL : 0755-27111216 FAX : 0755-29940187

-TOLERANCES- UNLESS OTHERWISE SPECIFIED 公差参数表						TITLE: 产品名称： EH2.5直针			
X.X	±0.30	X.X°	±3°	APPD: 核准：	谢亮	PART NO: 产品编号： HDGC2502WV-XP			
X.XX	±0.30	X.XX°	±2°	CHECK: 校对：	王建业	DATE	SCALE	UNIT	CODE NUMBER
X.XXX	±0.10	X.XXX°	±1°	DRAW: 绘图：	黄艳兰	2016-08-16	1:1	mm	A126