

深圳市晶力源科技有限公司

Shenzhen Jingliyuan Technology Co., Ltd.



产品规格书 SPECIFICATION

CUSTOMER(客户):	_____
PRODUCT TYPE(型号):	SMD-3.2*2.5MM(3225)
NOMINAL FREQ(频率):	37.4MHZ
JLY P/N(料号):	Y322537.4MFBCX
Brand(品牌):	JLYE晶力源
CUSTOMER P/N(客户料号):	_____

Client Opinion (客户意见)			
Hardware PL (工程)	QPM/SQE (品质)	Approval (核准)	Recognition (承认日期)

Provider (供应商)			
Drawn (制作)	Check (审核)	Approval (核准)	Submitted Date (日期)
刘来凤	徐超	李元	2026-05-18

公司地址 Company address: 深圳市福田区天安数码时代大厦2310室
23Floor, The South Tower Hu Bei Building Bin He Road ,Fu tian District, Shen Zhen
电话 TEL:+86-755-88914319: 传真 FAX:+86-755-88914315
公司网址 Company website: <http://www.cpssz.com>: 邮箱地址: Lisa@cpssz.com

深圳市晶力源科技有限公司

Shenzhen Jingliyuan Technology Co., Ltd.

● 石英晶体参数规格 (QUARTZ CRYSTAL UNIT SPECIFICATION)

NO	项目 Item	代码 Symbol	电气特性规格				备注 Notes
			下限 Min.	中心 Typ.	上限 Max.	单位 Units	
1	标称频率Nominal Frequency	F0	37.4			MHz	
2	振荡模式Oscillation Mode	-	Fundamental			-	
3	负载电容Load Capacitance	CL	12			pF	
4	频率公差Frequency Tolerance	-	-10	-	10	ppm	At 25°C±3°C
5	等效串联电阻ESR	ESR	-	-	40	Ω	
6	驱动功率Drive Level	DL	-	-	100	μW	
7	频率稳定度Frequency Stability	TC	-20	-	20	ppm	Over Operating Temp. Range(Ref. to
8	工作温度Operating Temperature	-	-40	-	85	°C	
9	储存温度Storage Temperature	-	-55	-	125	°C	
10	年老化率Aging	-	-3	-	3	ppm	Per Year
11	绝缘阻抗Insulation Resistance	-	500	-	-	MΩ	At DC 100V
12	并联电容Shunt Capacitance	C0	-	-	3	pF	

● OUTLINE DIMENSIONS(UNIT:mm) 外形尺寸 (单位: mm)

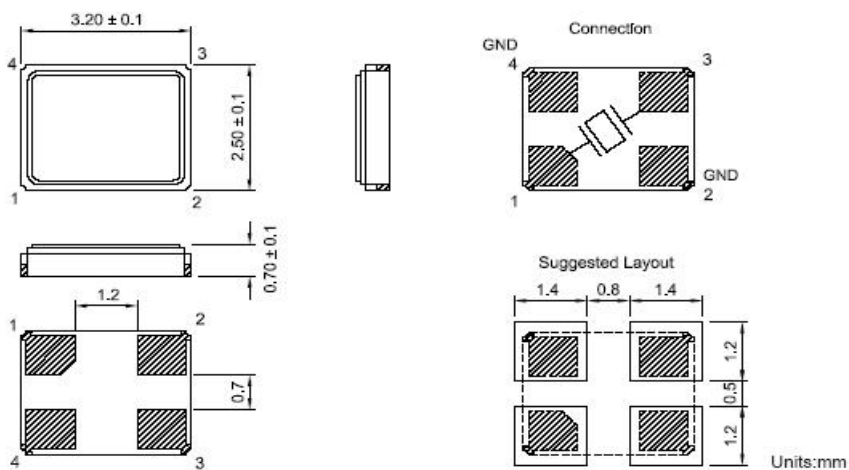

公司地址 Company address: 深圳市福田区天安数码时代大厦2310室
 23Floor, The South Tower Hu Bei Building Bin He Road ,Fu tian District, Shen Zhen
 电话 TEL:+86-755-88914319: 传真 FAX:+86-755-88914315
 公司网址 Company website:<http://www.cpssz.com>: 邮箱地址: Lisa@cpssz.com

深圳市晶力源科技有限公司

Shenzhen Jingliyuan Technology Co., Ltd.

● RELIABILITY SPECIFICATIONS (信赖度试验)

No	Test Item (测试项目)	Test Conditions (测试条件)	Reference (参考)
1	High Temperature High Humidity Storage (高温、高湿、储存)	Temperature: 85°C±3°C 温度: 85°C±3°C Relative Humidity: 85%RH 相对湿度: 85%RH Time: 96 Hours 时间: 96小时	JIS C5023
2	High Temperature Storage (高温储存)	Temperature: 125°C±3°C 温度: 125°C±3°C Time: 96 Hours 时间: 96小时	MIL-STD-883E Method 1005.8
3	Low Temperature Storage (低温储存)	Temperature: -40°C±3°C 温度: -40°C±3°C Time: 96Hours 时间: 96小时	MIL-STD-883E Method 1013
4	Thermal Shock (温度冲击)	Temperature1: -55°C±5°C 温度1: -55°C±5°C Temperature2: 85°C±5°C 温度2: 85°C±5°C Temperature change between T1 and T2 5 min T1和T2温度在5分钟内改变 10cycles maintain T1 and T2 for 30 minutes each mone cy 每次循环30分钟共10次	MIL-STD-202F Method 107 Condition A
5	RESISTANCE TO SOLDER HEAT (耐焊接热)	Solder Temperature: 260°C±5°C 焊槽温度: 260°C±5°C Time: 10±1 Seconds 时间: 10±1秒	MIL-STD-202F Method 210E
6	Solderability(可焊性)	The solder pot temperature is 245±5°C , dwell time 5±0.5sec 245±5°C焊锡槽浸润5±0.5秒	J-STD-002B
7	Drop Test (落下试验)	3 Times Free Fall from 75cm height table to 3cm thickness hard wood board 从75cm高度3次跌落到3cm厚硬质木板上	JIS C6701
8	MECHANICAL SHOCK (机械冲击)	Half sine wave, 1000 G 半正弦波, 加速度1000G 3 Times for all 3 directions X、Y、Z 三个相互垂直方向各三次	MIL-STD-202F Method 213B
9	Vibration (机械振动)	Frequency Range: 10Hz~55Hz 频率范围: 10Hz~55Hz Amplitude: 0.75mm 振幅: 0.75mm 2 Hours in each direction, total 6 Hours X、Y、Z 三个相互垂直方向各振动2小时	MIL-STD-883E Method 2007.3
10	Leakage Test (气密性)	Take measurements with a helium Leakage detector 氦质检漏 Leakage Rate ≤ 1×10 ⁻³ Pa cm ³ /s 漏率 ≤ 1×10 ⁻³ Pa cm ³ /s	MIL-STD-883E

公司地址 Company address: 深圳市福田区天安数码时代大厦2310室
23Floor, The South Tower Hu Bei Building Bin He Road , Fu tian District, Shen Zhen
电话 TEL: +86-755-88914319: 传真 FAX: +86-755-88914315
公司网址 Company website: <http://www.cpssz.com>: 邮箱地址: Lisa@cpssz.com

深圳市晶力源科技有限公司

Shenzhen Jingliyuan Technology Co., Ltd.

● SUGGESTED REFLOW PROFILE (回流焊曲线图)

Total time:200sec.Max. (总时间: 200秒 最大)

Solder melting point:220°C (熔点220 °C)

Profiles Feature (特性)		Pb-Free Assembly
Average Ramp-up Rate(Ts max to Tp)	平均升温速度	3°C/second Max
Preheat	预热	
■ Temperature Min (Ts min)	最低温度	125°C
■ Temperature Max (Ts max)	最高温度	200°C
■ Time (ts min to ts max)	从最低到最高时间	(60~180) seconds
Time maintained above	维持上述时间	
■ Temperature(T1)	温度	217°C
■ Time(tp)	时间	(60~150) seconds
Peak/Classification Temperature(Tp)	最高点温度	260 °C
Time within 5°C of actual Peak Temperature(tp)	高温维持时间	(20~40) seconds
Ramp-down rate	降温速度	6°C/second max
Time 25°C to Peak Temperature	从25°C到最高温度的时间	8 minutes max
Suggest reflow times	建议 reflow次数	3 Times max

IR-Reflow Profile

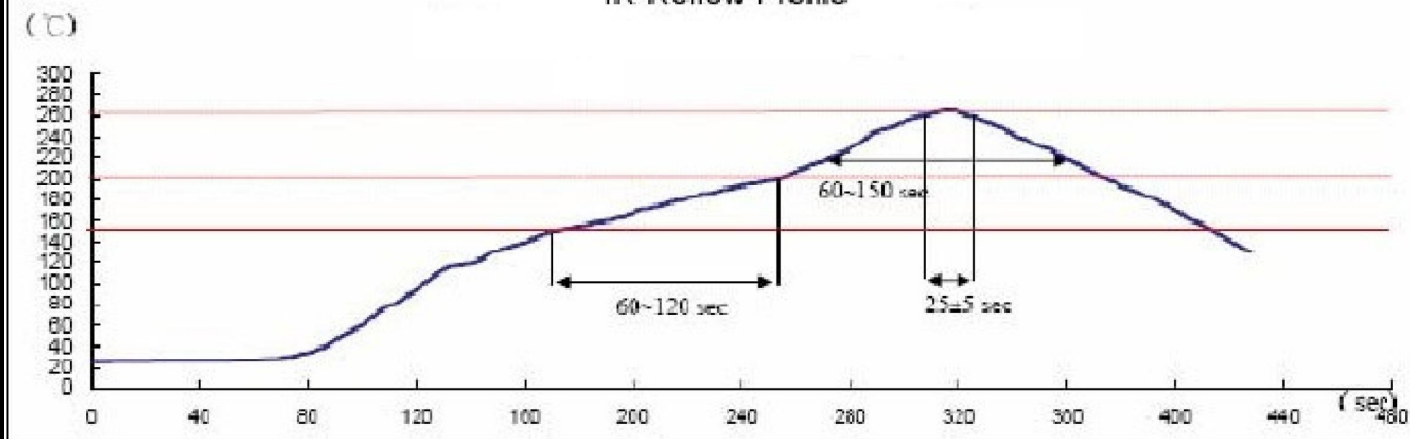

公司地址 Company address:深圳市福田区天安数码时代大厦2310室
 23Floor, The South Tower Hu Bei Building Bin He Road ,Fu tian District, Shen Zhen
 电话 TEL:+86-755-88914319: 传真 FAX:+86-755-88914315
 公司网址 Company website:<http://www.cpssz.com>: 邮箱地址: Lisa@cpssz.com

深圳市晶力源科技有限公司

Shenzhen Jingliyuan Technology Co., Ltd.

● PACKAGE

Tape Dimensions(unit : mm)

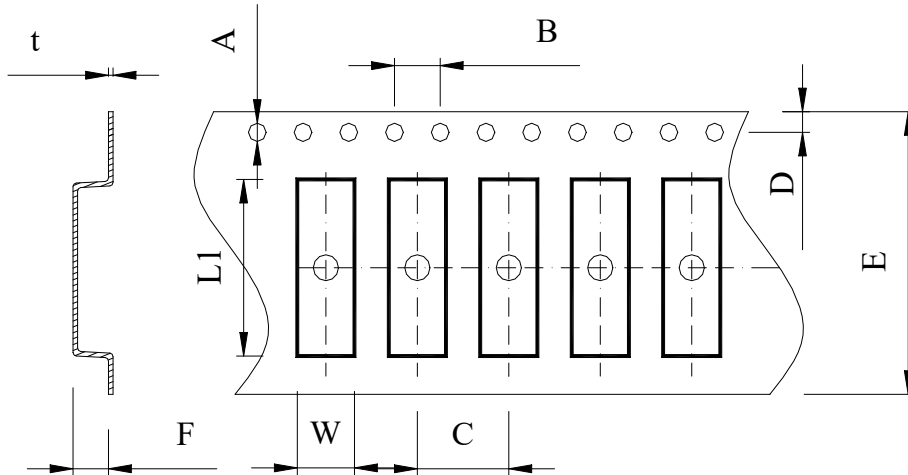

A	B	C	D	E	F	L1	W	T
1.5	4.0	4.0	1.75	8.0	1.0	3.6	2.9	0.3

● Reel Dimensions(unit: mm)

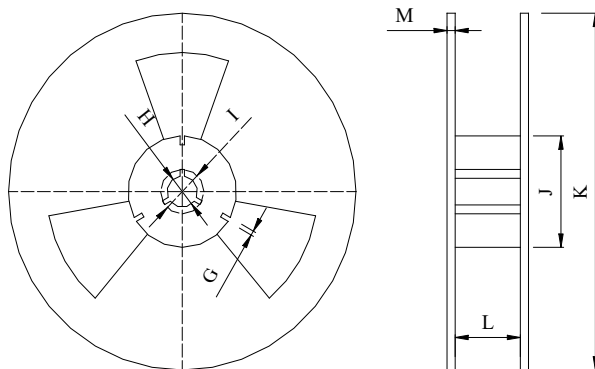

G	H	I	J	K	L	M
2.5	13.5	21.6	60.0	180.0	9.5	1.6

*3000pcs/Reel

公司地址 Company address:深圳市福田区天安数码时代大厦2310室
 23Floor, The South Tower Hu Bei Building Bin He Road ,Fu tian District, Shen Zhen
 电话 TEL:+86-755-88914319: 传真 FAX:+86-755-88914315
 公司网址 Company website:<http://www.cpssz.com>: 邮箱地址: Lisa@cpssz.com