

修订 REV	标记 MARK	修改摘要 REVISION DESCRIPTION	签名 SIGNATURE	日期 DATE
AO		NEW RELEASE	黄艳兰	2019-05-09

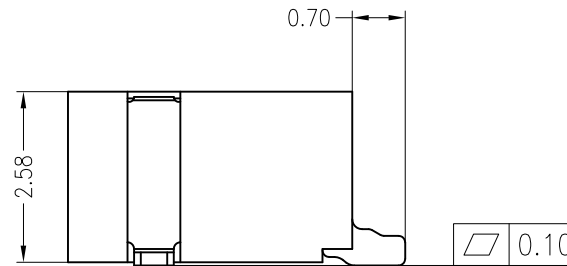
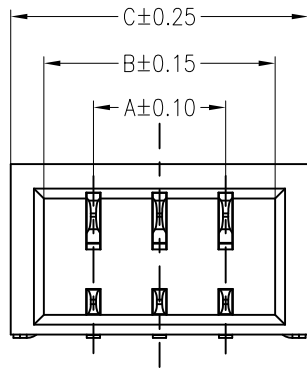
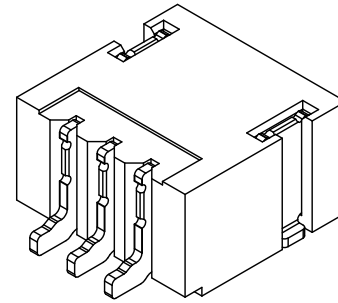
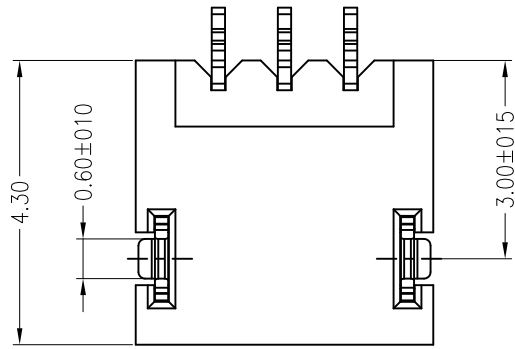

**Specifications:**

Poles: 02 to 20

Contact resistance:  $\leq 20m\Omega$

Insulation resistance:  $\geq 100M\Omega$

Rated voltage: 125V AC DC

Rated current: 1.0A AC DC

Withstand Voltage: 500V AC/minute

Temperature Range:  $-25^{\circ}C \sim +85^{\circ}C$

Housing: PA6T UL94V-0, Natural

Contacts: Phosphor Bronze/Matte Sn-plated

Solder Tabs: Brass/Matte Sn-plated

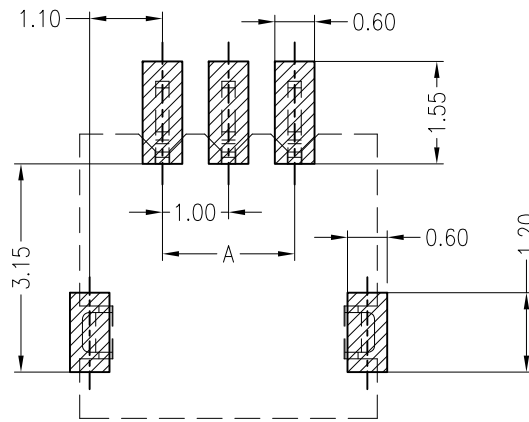

PCB LAYOUT(Tolerance:  $\pm 0.05$ )

孔位	尺寸	A	B	C	孔位	尺寸	A	B	C
2P	1.00	2.50	3.50	12P	11.00	12.5	13.5		
3P	2.00	3.50	4.50	13P	12.00	13.5	14.5		
4P	3.00	4.50	5.50	14P	13.00	14.5	15.5		
5P	4.00	5.50	6.50	15P	14.00	15.5	16.5		
6P	5.00	6.50	7.50	16P	15.00	16.5	17.5		
7P	6.00	7.50	8.50	17P	16.00	17.5	18.5		
8P	7.00	8.50	9.50	18P	17.00	18.5	19.5		
9P	8.00	9.50	10.5	19P	18.00	19.5	20.5		
10P	9.00	10.50	11.5	20P	19.00	20.5	21.5		
11P	10.00	11.50	12.5						



深圳市华德共创科技有限公司

Shenzhen Huade co-create Technology Co.,LTD

TEL : 0755-27111216 FAX : 0755-29940187

-TOLERANCES- UNLESS OTHERWISE SPECIFIED 公差参数表				TITLE: 产品名称: NH1.0卧贴				
X.X	$\pm 0.30$	X.X°	$\pm 3^{\circ}$	APPD: 核准: 谢亮	PART NO: 产品编号: HDGC1002WRF-S-XP			
X.XX	$\pm 0.30$	X.XX°	$\pm 2^{\circ}$	CHECK: 校对: 王建业	DATE	SCALE	UNIT	CODE NUMBER
X.XXX	$\pm 0.10$	X.XXX°	$\pm 1^{\circ}$	DRAW: 绘图: 黄艳兰	2019-05-09	1:1	mm	A018