

标记 MARK	ECN编号/变更内容 ECN NO/DEFINITION	修改 REVISE	日期 DATE	核准 APPROVE
------------	---------------------------------	--------------	------------	---------------

A	H
∅3.5	4.5
∅3.4	5.0
∅3.3	5.5
∅3.3	6.0
∅3.2	6.5
∅3.2	7.0
∅3.2	7.5
∅3.2	8.0
∅3.0	8.5
∅3.0	9.0
∅3.0	9.5
∅3.0	10.5
∅3.0	11.0
∅3.0	12.0
∅3.0	14.5

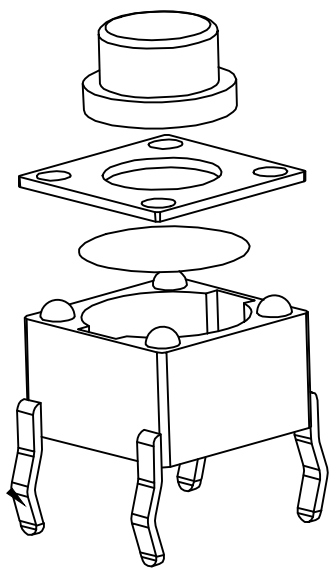
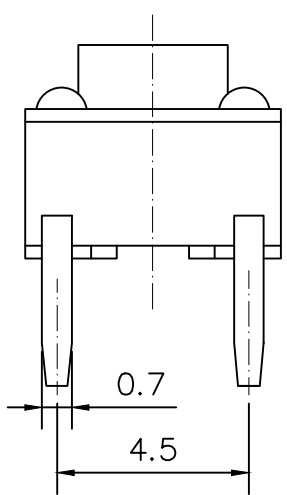
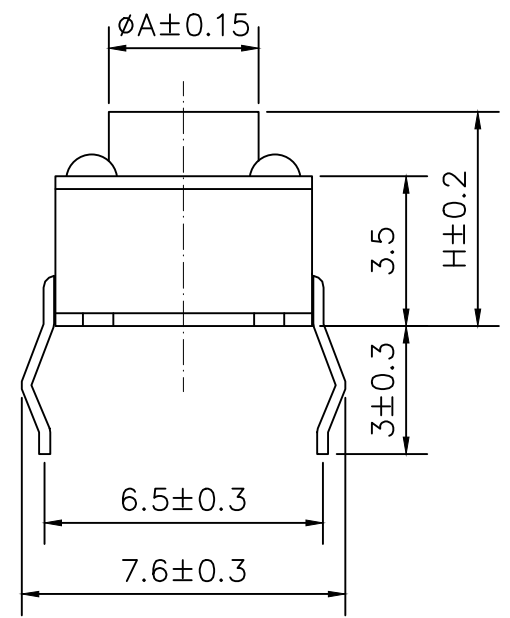

技术参数:

- 1. 使用温度: -25~+85°C
- 2. 额定负荷: DC 12V 50mA
- 3. 接触电阻: ≤50mΩ
- 4. 绝缘电阻: ≥100MΩ
- 5. 耐压: AC250V(50Hz)/min
- 6. 动作力: 260±50g
- 7. 使用寿命: 80,000次

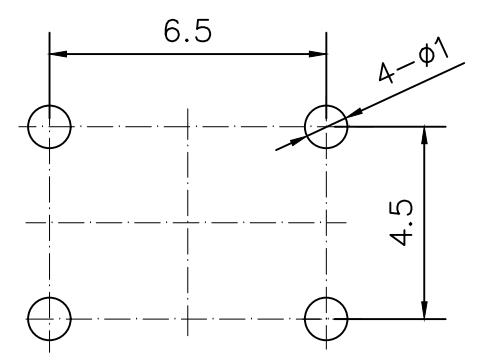
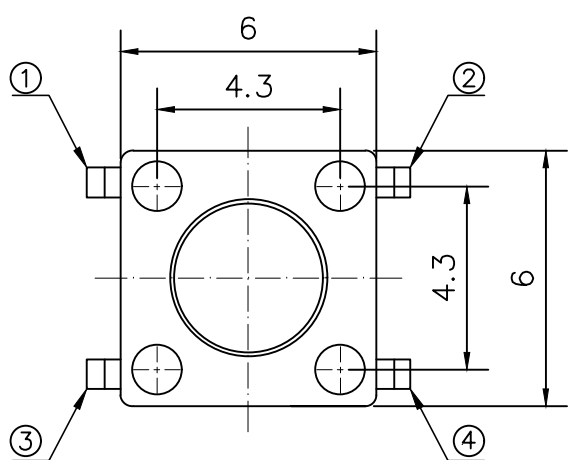

PCB线路板安装图(±0.1)

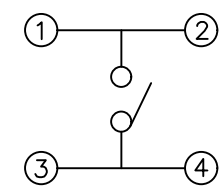

电路图

3	盖板	冷轧钢	Cu/Sn	
2	弹片	不锈钢	镀银	
1	基座	PPA	黑色	
序号	品名	材质	电镀/颜色	备注

	深圳市虹成电子有限公司		品名 TITLE	轻触开关	
			料号 PART NO	HC-QC6645-C-R	
GENERAL TOLERANCES (UNLESS SPECIFIED)		比列 SCALE	1:1		
X. ±0.20	X'. ±1'	单位 UNIT	MM		
.X ±0.15	.X' ±0.5'	张数 PART NO	1 OF 1		
.XX ±0.05	.XX' ±0.1'	版本 REV	A	制图 DRAW	AhYe
			审核 CHECKED	夏操云	
			批准 APPROVE	赵亮亮	