

标记 MARK	ECN编号/变更内容 ECN NO/DEFINITION	修改 REVISE	日期 DATE	核准 APPROVE
------------	---------------------------------	--------------	------------	---------------

PIN NUMBER	SIGNAL NAME	PIN NUMBER	SIGNAL NAME
A1	GND	B12	GND
A2	SSTXp1	B11	SSRXp1
A3	SSTXn1	B10	SSRXn1
A4	VBUS	B9	VBUS
A5	CC1	B8	SBU2
A6	Dp1	B7	Dn2
A7	Dn1	B6	Dp2
A8	SBU1	B5	CC2
A9	VBUS	B4	VBUS
A10	SSRXn2	B3	SSTXn2
A11	SSRXp2	B2	SSTXp2
A12	GND	B1	GND

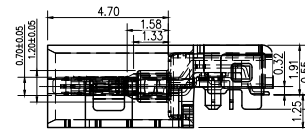
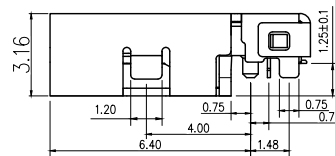
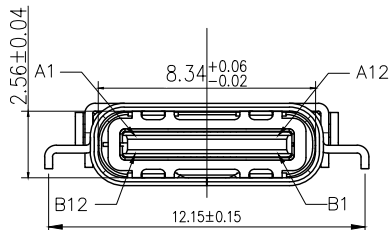
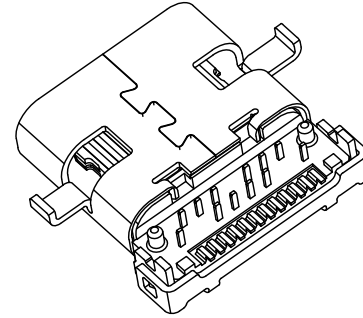
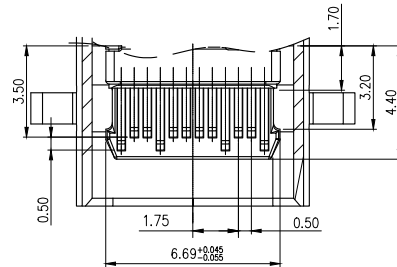
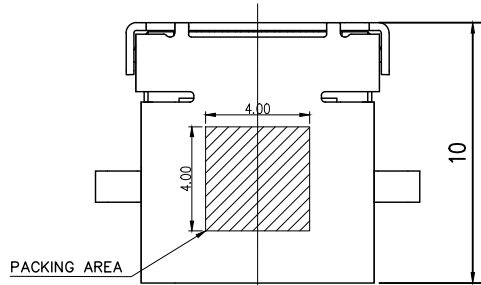

备注:

1. 材质:
  - 1.1 胶芯: LCP+30%G.F
  - 1.2 端子: 高导电C7025, T=0.12mm;
  - 1.3 外壳: SUS304, T=0.30mm;
  - 1.4 中夹片: SUS301, T=0.12mm;
2. 主要特性:
  - 2.1 额定电流: 5A
  - 2.2 接触阻抗: 40mΩ MAX (初始值)  
50m Ω MAX (测试后)
  - 2.3 绝缘阻抗: 100MΩ MIN
  - 2.4 耐压测试: 100V AC R.M.S.
  - 2.6 整体插入力: 5-20N 整体插入力: 5-20N (耐久后)  
整体拔出力: 8-20N 整体拔出力: 5-20N (耐久后)
  - 2.7 耐久: 10000次
  - 2.8 耐高温: SMT 回流焊 (峰值260° ±5°), 塑胶不能有起泡, 融胶等不良, 变色, 翘曲变形在公差范围之内;
- 2.9 产品须做焊锡测试, 粘锡面积达到95%以上;
- 3.0 盐雾测试: 48H MIN
- 3.1 工作温度: -30℃ ~ +85℃

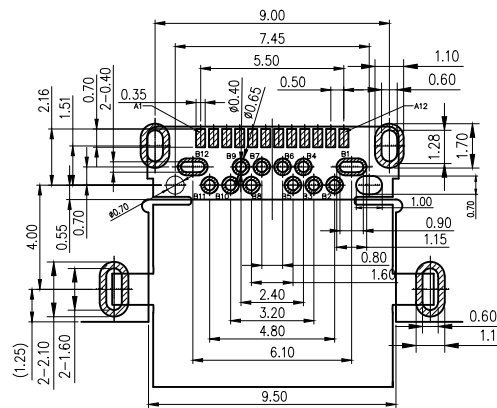
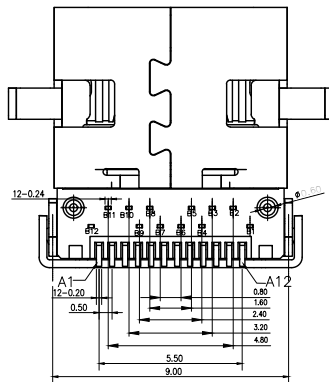

RECOMMENDED PCB LAYOUT(TOP VIEW)

3	外壳	不锈钢	—	
2	接触	铜	镀金	
1	基座	LCP	黑色	
序号	品名	材质	电镀/颜色	备注

	深圳市虹成电子有限公司		品名 TITLE	TYPE-C母座
			料号 PART NO	HC-TYPE-C-24P-C033B
GENERAL TOLERANCES (UNLESS SPECIFIED)		比列 SCALE	1:1	
.000 ±0.10	单位 UNIT	MM	制图 DRAW	
.00 ±0.20	张数 PART NO	1 OF 1	审核 CHECKED	夏操云
.0 ±0.30	版本 REV	A	批准 APPROVE	赵亮亮
角度 ±1°				