

7	8	9
标记 MARK	ECN编号/变更内容 ECN NO/DEFINITION	修改 REVISE
		日期 DATE
		核准 APPROVE

A	H
φ6.8	4.3
φ6.8	4.5
φ6.7	5.0
φ6.5	5.5
φ6.5	6.0
φ6.4	6.5
φ6.3	7.0
φ6.2	7.5
φ6.15	8.0
φ6.15	8.5
φ6.05	10.0
φ6.05	13.0

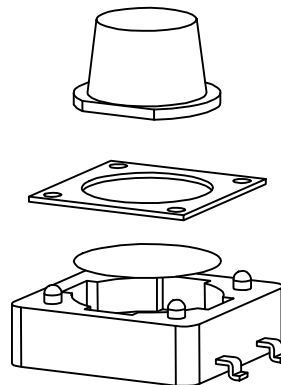
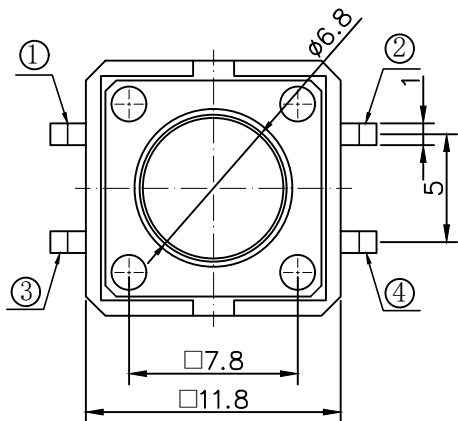
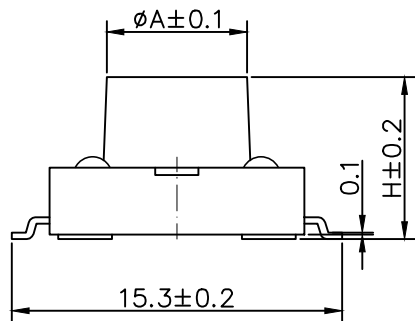

技术参数:

1. 使用温度: -25°C ~ +85°C
2. 额定负荷: DC 12V 50mA
3. 接触电阻: ≤50mΩ
4. 绝缘电阻: ≥100MΩ
5. 耐压: AC250V (50Hz)/min
6. 动作力: 260±50g
7. 使用寿命: 50,000次

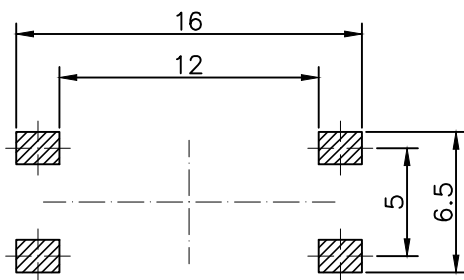
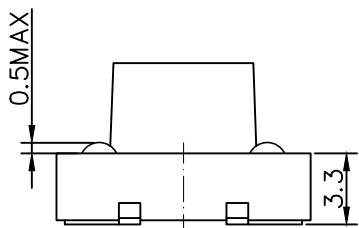

PCB线路板安装图(±0.1)

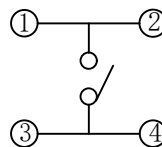

电路图

3	盖板	冷轧钢	Cu/Sn	
2	弹片	不锈钢	镀银	
1	基座	PPA	黑色	
序号	品名	材质	电镀/颜色	备注

深圳市虹成电子有限公司 品名 TITLE 料号 PART NO		轻触开关	
		HC-QC121275-T-R	
GENERAL TOLERANCES (UNLESS SPECIFIED)		比列 SCALE	1:1
X. ±0.20	X'. ±1'	单位 UNIT	MM
.X ±0.15	.X' ±0.5'	张数 PART NO	1 OF 1
.XX ±0.05	.XX' ±0.1'	版本 REV	A
		制图 DRAW	AhYe
		审核 CHECKED	夏操云
		批准 APPROVE	赵亮亮

