

标记 MARK	ECN编号/变更内容 ECN NO/DEFINITION	修改 REVISE	日期 DATE	核准 APPROVE
			A	H
			φ3.5	4.3
			φ3.5	4.5
			φ3.4	5.0
			φ3.3	5.5
			φ3.3	6.0
			φ3.2	6.5
			φ3.2	7.0
			φ3.2	7.5
			φ3.0	9.0
			φ3.0	10.0
			φ3.0	12.0
			φ3.0	13.0

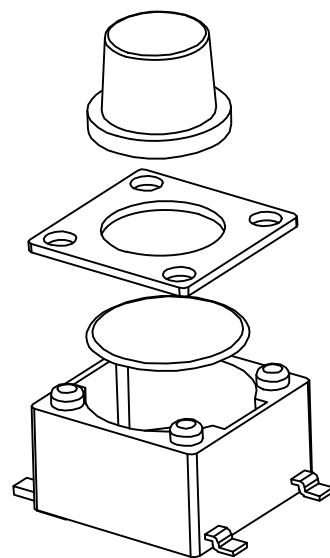

技术参数:

1. 使用温度: -25~+85°C
2. 额定负荷: DC 12V 50mA
3. 接触电阻: ≤50mΩ
4. 绝缘电阻: ≥100MΩ
5. 耐压: AC250V(50Hz)/min
6. 动作力: 260±50g
7. 使用寿命: 80,000次

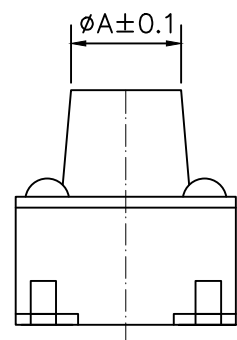
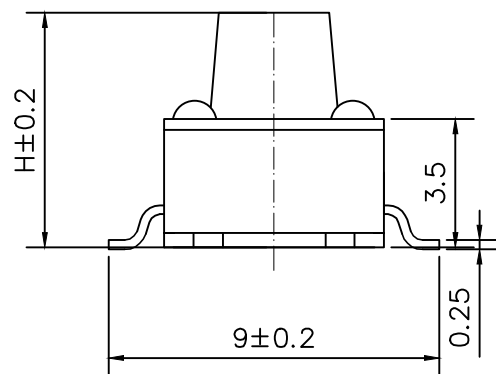
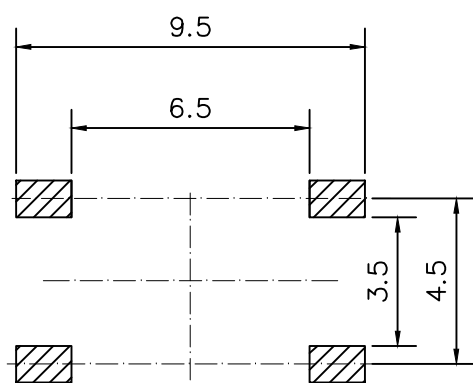
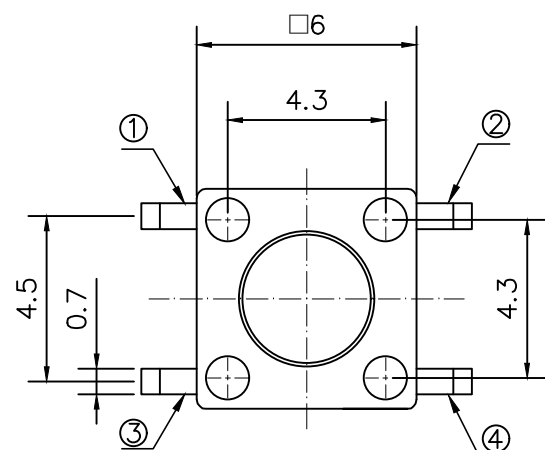

PCB线路板安装图(±0.1)

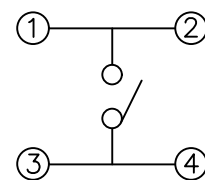

电路图

3	盖板	冷轧钢	Cu/Sn	
2	弹片	不锈钢	镀银	
1	基座	PPA	黑色	
序号	品名	材质	电镀/颜色	备注

深圳市虹成电子有限公司		品名 TITLE	轻触开关	
		料号 PART NO	HC-QC6670-T-R	
GENERAL TOLERANCES (UNLESS SPECIFIED)		比列 SCALE	1:1	
X. ±0.20	X'. ±1'	单位 UNIT	MM	制图 DRAW
.X ±0.15	.X' ±0.5'	张数 PART NO	1 OF 1	审核 CHECKED
.XX ±0.05	.XX' ±0.1'	版本 REV	A	批准 APPROVE