

标记 MARK	ECN编号/变更内容 ECN NO/DEFINITION	修改 REVISE	日期 DATE	核准 APPROVE
			A	H
			φ2.4	3.5
			φ2.35	3.8
			φ2.35	4.0
			φ2.3	4.5
			φ2.3	4.8
			φ2.3	5.0
			φ2.2	5.5
			φ2.2	6.0
			φ2.15	6.5
			φ2.2	7.0
			φ2.1	8.0
			φ2.05	9.0

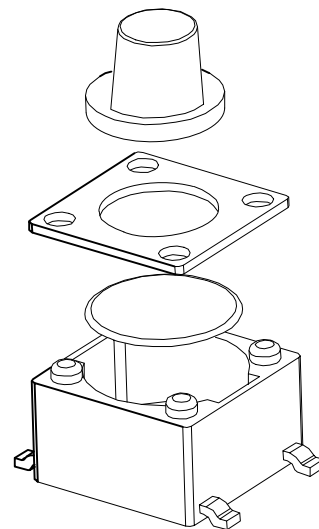

技术参数:

1. 使用温度: -25~+85°C
2. 额定负荷: DC 12V 50mA
3. 接触电阻: ≤50mΩ
4. 绝缘电阻: ≥100MΩ
5. 耐压: AC250V(50Hz)/min
6. 动作力: 260±50g
7. 使用寿命: 50,000次

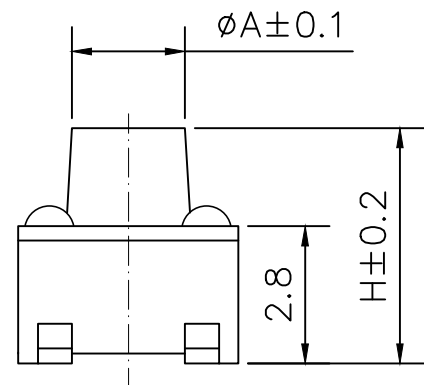
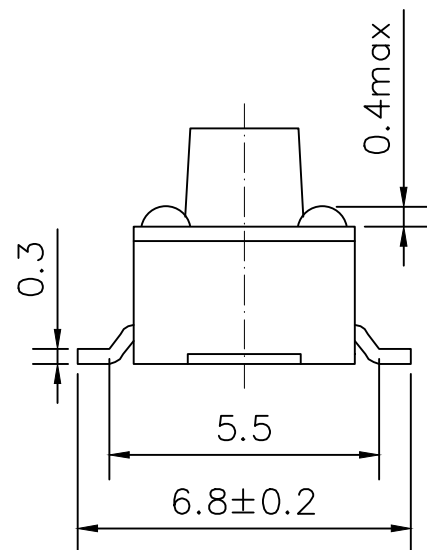
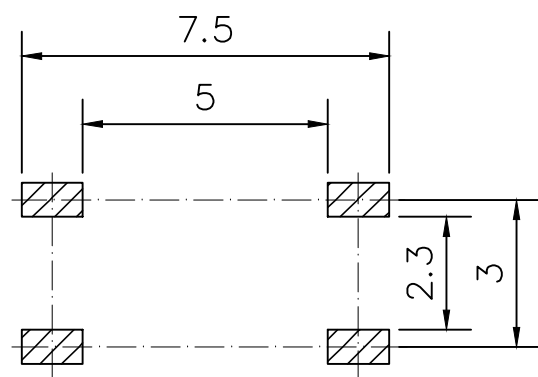
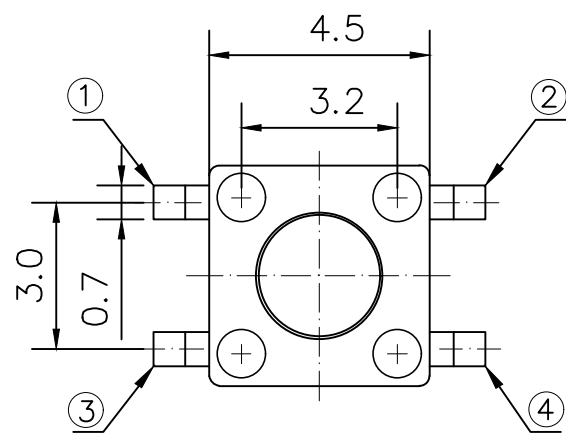

PCB线路板安装图(±0.1)

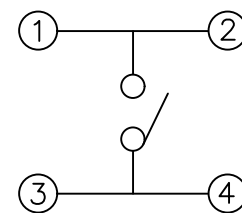

电路图

序号	品名	材质	电镀/颜色	备注
3	盖板	冷轧钢	Cu/Sn	
2	弹片	不锈钢	—	
1	基座	PPA	黑色	

	深圳市虹成电子有限公司		品名 TITLE	轻触开关	
			料号 PART NO	HC-QC454540-T-R	
GENERAL TOLERANCES (UNLESS SPECIFIED)		比列 SCALE	1:1		
X. ±0.20	X'. ±1'	单位 UNIT	MM	制图 DRAW	AhYe
.X ±0.15	.X' ±0.5'	张数 PART NO	1 OF 1	审核 CHECKED	夏操云
.XX ±0.05	.XX' ±0.1'	版本 REV	A	批准 APPROVE	赵亮亮

