

- ✓ Medical IEC 60601-1 3rd Edition Safety
- ✓ EN 60601-1-2 4th Edition EMC
- ✓ EN 55011 (CISPR11) Class B Emissions
- ✓ BF Leakage Current, 2 MOPP Isolation
- ✓ Class II Option Available for Home Medical Applications (BSM550 Models)
- ✓ 5V and 12V Auxiliary Outputs
- ✓ Current Sharing Capability Enables Parallel Operation for Higher Power Needs
- ✓ Remote Output Enable and Power Good Signal
- ✓ Remote Sense Input
- ✓ High Efficiency, up to 92% at 230 VAC
- ✓ Universal 80-275 VAC Input, 50/60 Hz
- ✓ Variable Speed Fan for Low Load Noise Reduction
- ✓ Available in Open Frame, U-Channel and Enclosed with Fan Configurations

PRODUCT DESCRIPTION

The Astrodyne TDI ASM550/BSM550 series power supplies are high power density, medical grade designs for both medical and industrial applications. Both the ASM550 series with Class I protection and the BSM550 series with Class II protection have 2 MOPP isolation and BF leakage current, crucial for patient safety either in the hospital or at home.

These power supplies operate over the input voltage range of 80 to 275 VAC at 50-60Hz frequency and deliver up to 550 Watts of regulated DC output power in a low profile form factor that is 1U height compatible. A current sharing feature allows multiple units to be used in parallel for very high power delivery. These power supplies are compliant with DoE Level VI efficiency requirements and the RoHS directive.

The ASM550/BSM550 series products have been certified to the IEC 60601-1 3rd Edition international medical safety standard. They are also certified to the collateral standard EN 60601-1-2 4th Edition for electromagnetic compatibility.

Product Models

Model ⁽¹⁾	Output Voltage	Output Current Forced Air / Convection ^(2,3)	5V Aux. Current Forced Air / Convection ^(2,3)	12V Aux. Current Forced Air / Convection ^(2,3,4)	Efficiency (Typ) 230 /115 VAC
Enclosed Models (Integrated Fan) with Headers					
ASM550-120-BEH-S00	12 VDC	45.0A / N.A.	2A / N.A.	0.5A / N.A.	90% / 88%
ASM550-150-BEH-S00	15 VDC	36.7A / N.A.	2A / N.A.	0.5A / N.A.	90% / 88%
ASM550-180-BEH-S00	18 VDC	30.6A / N.A.	2A / N.A.	0.5A / N.A.	90% / 88%
ASM550-240-BEH-S00	24 VDC	22.9A / N.A.	2A / N.A.	0.5A / N.A.	92% / 88%
ASM550-280-BEH-S00	28 VDC	19.6A / N.A.	2A / N.A.	0.5A / N.A.	92% / 88%
ASM550-360-BEH-S00	36 VDC	15.3A / N.A.	2A / N.A.	0.5A / N.A.	92% / 88%
ASM550-480-BEH-S00	48 VDC	11.5A / N.A.	2A / N.A.	0.5A / N.A.	92% / 88%
ASM550-540-BEH-S00	54 VDC	10.5A / N.A.	2A / N.A.	0.5A / N.A.	92% / 88%
Open Frame Models with Headers					
ASM550-120-BNH-S00	12 VDC	45.0A / 20.8A	2A / 1A	1A / 0.5A	90% / 88%
ASM550-150-BNH-S00	15 VDC	36.7A / 16.7A	2A / 1A	1A / 0.5A	90% / 88%
ASM550-180-BNH-S00	18 VDC	30.6A / 13.9A	2A / 1A	1A / 0.5A	90% / 88%
ASM550-240-BNH-S00	24 VDC	22.9A / 11.6A	2A / 1A	1A / 0.5A	92% / 88%
ASM550-280-BNH-S00	28 VDC	19.6A / 10.0A	2A / 1A	1A / 0.5A	92% / 88%
ASM550-360-BNH-S00	36 VDC	15.3A / 7.8A	2A / 1A	1A / 0.5A	92% / 88%
ASM550-480-BNH-S00	48 VDC	11.5A / 5.8A	2A / 1A	1A / 0.5A	92% / 88%
ASM550-540-BNH-S00	54 VDC	10.5A / 5.2A	2A / 1A	1A / 0.5A	92% / 88%
U-Channel Models with Headers					
ASM550-120-BUH-S00	12 VDC	45.0A / 20.8A	2A / 1A	1A / 0.5A	90% / 88%
ASM550-150-BUH-S00	15 VDC	36.7A / 16.7A	2A / 1A	1A / 0.5A	90% / 88%
ASM550-180-BUH-S00	18 VDC	30.6A / 13.9A	2A / 1A	1A / 0.5A	90% / 88%
ASM550-240-BUH-S00	24 VDC	22.9A / 11.6A	2A / 1A	1A / 0.5A	92% / 88%
ASM550-280-BUH-S00	28 VDC	19.6A / 10.0A	2A / 1A	1A / 0.5A	92% / 88%
ASM550-360-BUH-S00	36 VDC	15.3A / 7.8A	2A / 1A	1A / 0.5A	92% / 88%
ASM550-480-BUH-S00	48 VDC	11.5A / 5.8A	2A / 1A	1A / 0.5A	92% / 88%
ASM550-540-BUH-S00	54 VDC	10.5A / 5.2A	2A / 1A	1A / 0.5A	92% / 88%

Notes:

1. The “ASM” series has Class I protection; use the “BSM” prefix for Class II protection
2. The current ratings for Convection use are based on a 90 VAC Input at 25 degrees C only; refer to the derating curves for detail at other AC input voltages and ambient temperatures.
3. The current ratings for Forced Air are based on the presence of the minimum specified air flow requirements; refer to the derating curves for detail with other air flow rates.
4. The embedded fan in the enclosed models consumes 0.5 A of the available current from the 12V Aux. output.

550W High Power Density Medical Grade Power Supplies

ASM550/BSM550

Model ⁽¹⁾	Output Voltage	Output Current Forced Air / Convection^(2,3)	5V Aux. Current Forced Air / Convection^(2,3)	12V Aux. Current Forced Air / Convection^(2,3,4)	Efficiency (Typ) 230 /115 VAC
Enclosed Models (Integrated Fan) with Terminal Blocks					
ASM550-120-BET-S00	12 VDC	45.0A / N.A.	2A / N.A.	0.5A / N.A.	90% / 88%
ASM550-150-BET-S00	15 VDC	36.7A / N.A.	2A / N.A.	0.5A / N.A.	90% / 88%
ASM550-180-BET-S00	18 VDC	30.6A / N.A.	2A / N.A.	0.5A / N.A.	90% / 88%
ASM550-240-BET-S00	24 VDC	22.9A / N.A.	2A / N.A.	0.5A / N.A.	92% / 88%
ASM550-280-BET-S00	28 VDC	19.6A / N.A.	2A / N.A.	0.5A / N.A.	92% / 88%
ASM550-360-BET-S00	36 VDC	15.3A / N.A.	2A / N.A.	0.5A / N.A.	92% / 88%
ASM550-480-BET-S00	48 VDC	11.5A / N.A.	2A / N.A.	0.5A / N.A.	92% / 88%
ASM550-540-BET-S00	54 VDC	10.5A / N.A.	2A / N.A.	0.5A / N.A.	92% / 88%
U-Channel Models with Terminal Blocks					
ASM550-120-BUT-S00	12 VDC	45.0A / 20.8A	2A / 1A	1A / 0.5A	90% / 88%
ASM550-150-BUT-S00	15 VDC	36.7A / 16.7A	2A / 1A	1A / 0.5A	90% / 88%
ASM550-180-BUT-S00	18 VDC	30.6A / 13.9A	2A / 1A	1A / 0.5A	90% / 88%
ASM550-240-BUT-S00	24 VDC	22.9A / 11.6A	2A / 1A	1A / 0.5A	92% / 88%
ASM550-280-BUT-S00	28 VDC	19.6A / 10.0A	2A / 1A	1A / 0.5A	92% / 88%
ASM550-360-BUT-S00	36 VDC	15.3A / 7.8A	2A / 1A	1A / 0.5A	92% / 88%
ASM550-480-BUT-S00	48 VDC	11.5A / 5.8A	2A / 1A	1A / 0.5A	92% / 88%
ASM550-540-BUT-S00	54 VDC	10.5A / 5.2A	2A / 1A	1A / 0.5A	92% / 88%

Notes:

1. The “ASM” series has Class I protection; use the “BSM” prefix for Class II protection
2. The current ratings for Convection use are based on a 90 VAC Input at 25 degrees C only; refer to the derating curves for detail at other AC input voltages and ambient temperatures.
3. The current ratings for Forced Air are based on the presence of the minimum specified air flow requirements; refer to the derating curves for detail with other air flow rates.
4. The embedded fan in the enclosed models consumes 0.5 A of the available current from the 12V Aux. output.

INPUT SPECIFICATIONS

AC Input Voltage Range	100-240 VAC nominal 80-275 VAC tested
Input Frequency	47-63 Hz (50/60 Hz nominal)
DC Input Voltage Range	110-380 VDC
Input Current	7.0A max at 100VAC, 60Hz 3.5A max at 240VAC, 50Hz
Inrush Current	30A max at 100VAC, 60Hz 60A max at 240VAC, 50Hz
Power Factor	0.95 min at 230VAC, 50Hz
Earth Leakage Current	300uA max at 264VAC
Touch Leakage Current	60uA typ, 100uA max at 264VAC (BF Rating)
Input Fuse	10A on both ACL and ACN

MAIN OUTPUT SPECIFICATIONS

Output Voltage	see Product Model charts
Output Power	550W max – see derating
Minimum Load	No minimum load required
Set Point Accuracy	±1% max
Load Regulation	±1% max, no load to full load
Line Regulation	±0.5% max, 90-264 VAC
Efficiency	see Product Model charts
Standby Power	0.5W max
Hold-up Time	16ms typ., full load, 115VAC
Ripple and Noise	1% pk-pk max, 20MHz BW, measured with 47uF Alum and 0.1uF Ceramic at output

ISOLATION

Input to Output	4000 VAC, 2 MOPP
Input to Earth (Class I)	1500 VAC, 1 MOPP
Output to Earth (Class I)	500 VAC

PROTECTION

Over Current *	105 to 135% Rated Current
Short Circuit *	Hiccup Mode, Automatic recovery
Over Voltage *	130% Vo max, Latching; Recycle Input to Reset
Over Temperature *	Automatic recovery

All specifications are typical at nominal input, full load, 25°C unless specified otherwise.

SAFETY AND COMPLIANCE CERTIFICATIONS

Safety Approvals	IEC 60601-1 3 rd Ed, Amend 1: TUV, CB/CE, CSA C22.2
EMC Overall	EN60601-1-2, 4 th Ed, Class B
Conducted and Radiated Emissions	EN 55011 (CISPR11), Class B;
Harmonic Current	EN 61000-3-2, Class B
Voltage Fluctuations	EN 61000-3-3
ESD Immunity	EN 61000-4-2, Level 4
RF Field Immunity	EN 61000-4-3, Level 3
EFT Burst Immunity	EN 61000-4-4, Level 3
Surge Immunity	EN 61000-4-5, Level 3
Conducted Immunity	EN 61000-4-6, Level 3
Magnet Field Immunity	EN 61000-4-8, Level 4
Voltage Dips and Interruptions	EN 61000-4-11

ENVIRONMENTAL SPECIFICATIONS

Operating Temperature (120VAC, 45 CFM air flow; see derate charts for other input and airflow conditions)	-20 to +50°C at full load, up to +75°C at reduced load See derating chart for detail
Cooling	Forced air or free air convection
Storage Temperature*	-40 to +85°C
Operating Humidity*	0% to 95%, non-condensing
Operating Altitude	0-3000m / 0-10,000 ft
Vibration	2G rms, 5-500Hz, 3 axes, 30min.

MECHANICAL SPECIFICATIONS

Size **	3.7" x 7.0" x 1.32" 94.0 x 177.8 x 33.6 mm
Weight	1.37 lbs / 620 g
Connectors	see Outline Drawings

** Open frame size only; for U-channel and enclosed, refer to Outline Drawings

* These are stress ratings. Exposure of the devices to any of these conditions may adversely affect long term reliability. Operation under conditions other than the standard operating conditions is neither warranted nor implied.

OPERATION GUIDE AND APPLICATION INFORMATION

PS_ON: Power Supply Control – Enables/disables the main output and the 12V aux output

- Connect the PS_ON signal (CN4, pin 6) to 5V_AUX_RTN (CN4, pin 1) to enable the main and 12V aux outputs. Disconnect to disable.
- Note that the 5V aux output is always on when the AC input is applied.

PWR_OK: Power Good Indicator – Indicates when the main output is in regulation

- The PWR_OK connection (CN4, pin 4) is open-collector logic; the signal goes high (3.3V to 5V range) approximately 160ms after the main output has achieved regulation. Logic low is less than 1V.

REMOTE_SENSE: Output Voltage Compensation – Uses a separate connection to measure the output voltage at the load, and automatically adjusts the voltage at the output terminals to compensate for line voltage drop.

- Connect the REMOTE_SENSE input (CN4, pin 8) to a separate wire that terminates at the point of load on the positive side.

Parallel Operation of Multiple Units for N+1 Redundancy or High Output Power Applications up to 3kW

- Up to six ASM550 or BSM550 units may be connected in parallel, to support N+1 redundancy or high output power applications up to 3 kiloWatts.
- Each unit has an embedded ORing device, which eliminates the need for additional external components.
- A voltage droop method is used to balance load current sharing.
- The REMOTE_SENSE signal (CN4, pin 8) of each unit should be connected directly to the load point separately.

Parallel and N+1 Operation Connection Diagram

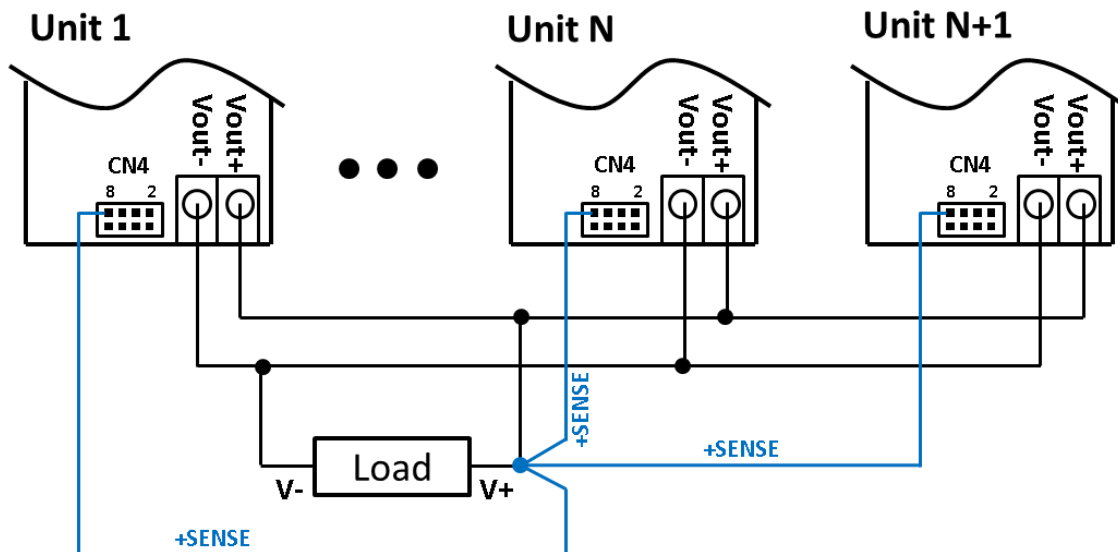

THERMAL PERFORMANCE

Jumper J6 defines the Over Current Protection threshold, and is factory-installed for operation to a 550 Watt load rating with forced air cooling. For a natural convection cooling application with an AC input voltage in the range of 90~120VAC, it is recommended to remove jumper J6 and limit operation to a maximum 300 Watt load. Refer to the Outline Drawings for the location of jumper J6.

Jumper J6 Settings

J6 Setting	Maximum Load Power	Application
Installed	550 Watts	Cooled by forced air (either using embedded fan or by providing up to 80 CFM airflow)
Removed	300 Watts	Cooled by free air convection *

* On models with a DC output voltage of 24V to 54V, a nominal 230VAC input will support an output load power up to 380 Watts under free air convection. For such operation, jumper J6 must be installed. Note that operating the product in this manner at load powers above 380 Watts will degrade operating life.

Output Power Derating – Enclosed Models (all rated input voltages)

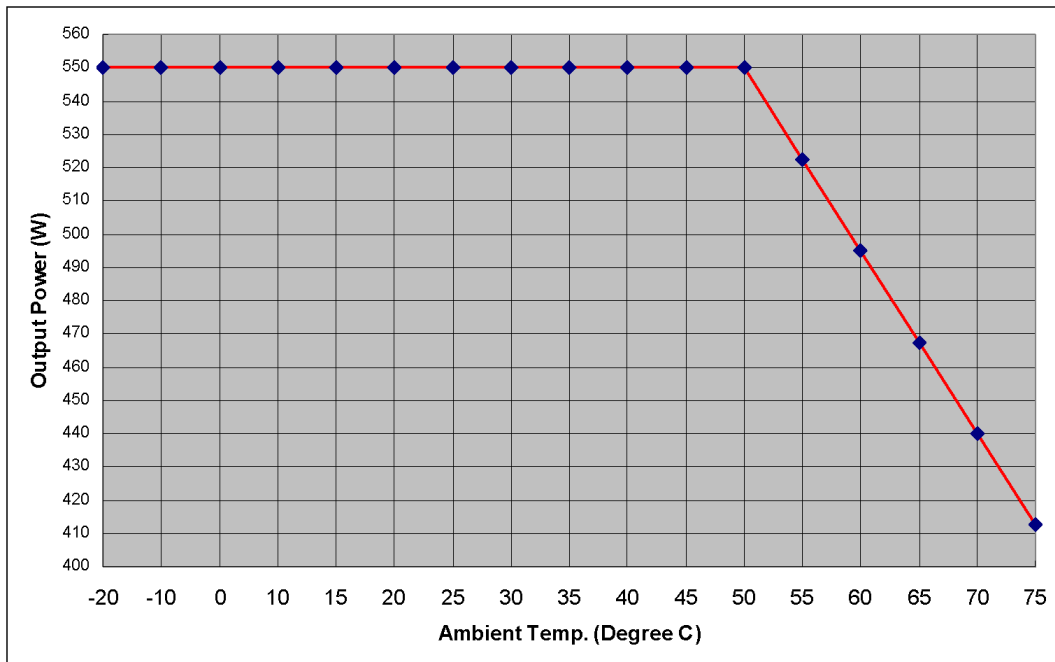

Output Power Derating – Forced Air Cooling for Open Frame and U-Channel Models

Thermal considerations for Open Frame and U-Channel models:

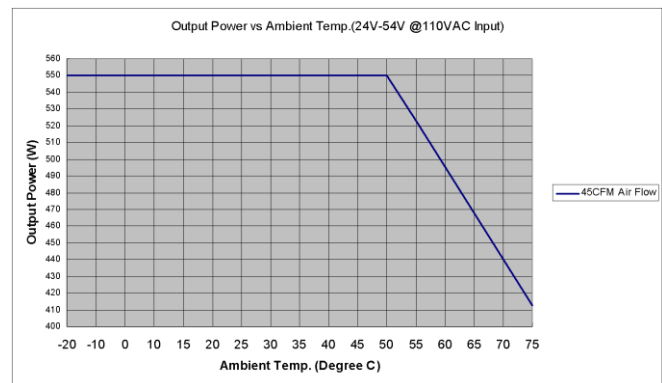
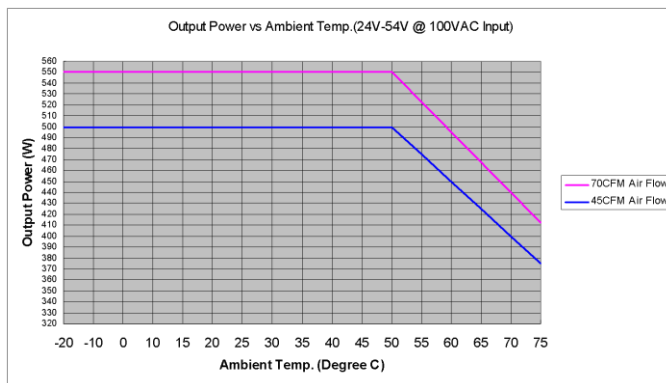
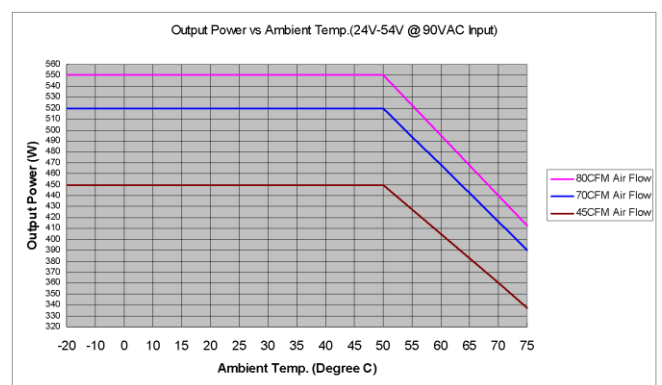
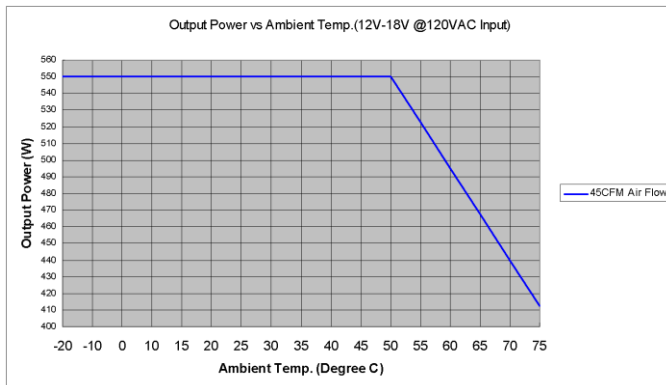
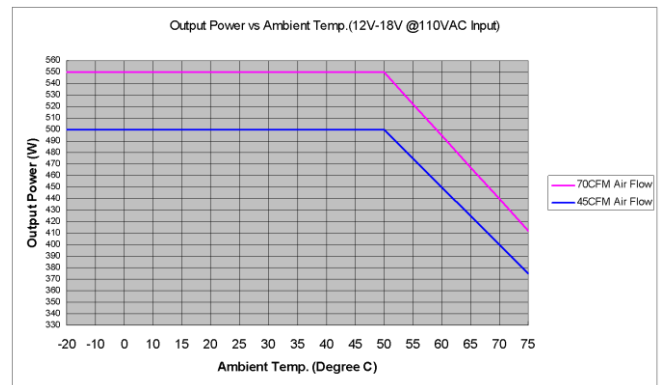
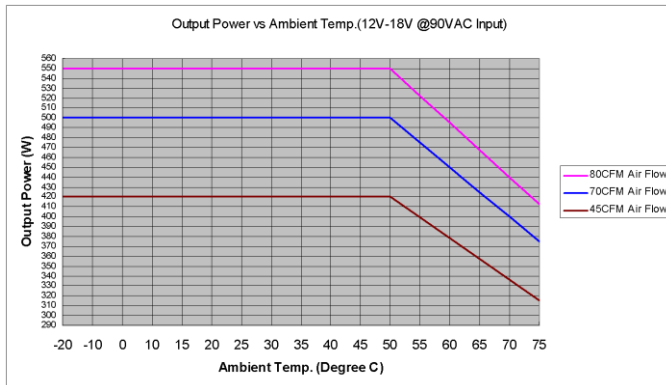
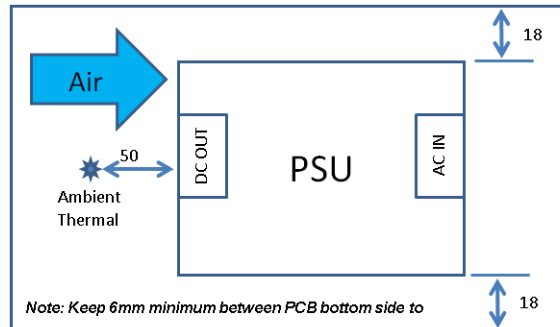

Output Power Derating – Free Air Convection Cooling for Open Frame and U-Channel Models

Note: It is recommended that jumper J6 be removed for applications cooled by free air convection. Refer to Jumper J6 details, listed above.

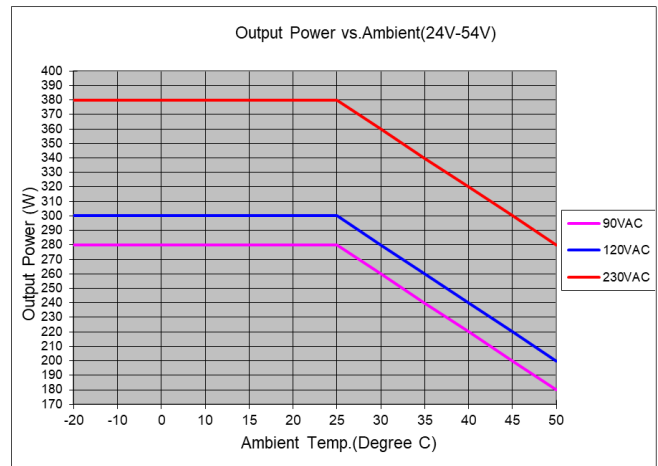
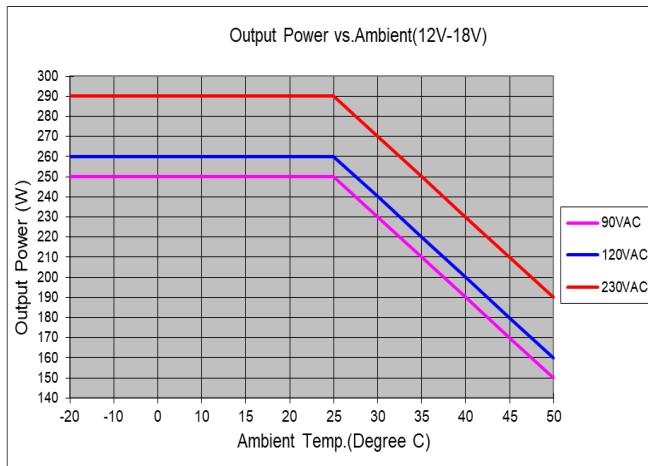
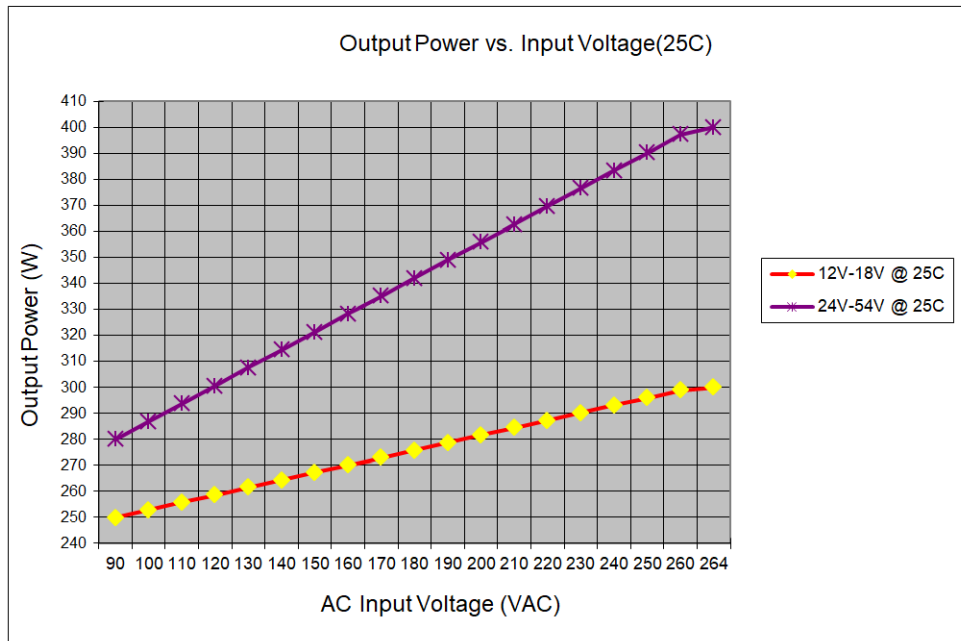

OUTLINE DRAWINGS

U-Channel with Terminal Blocks

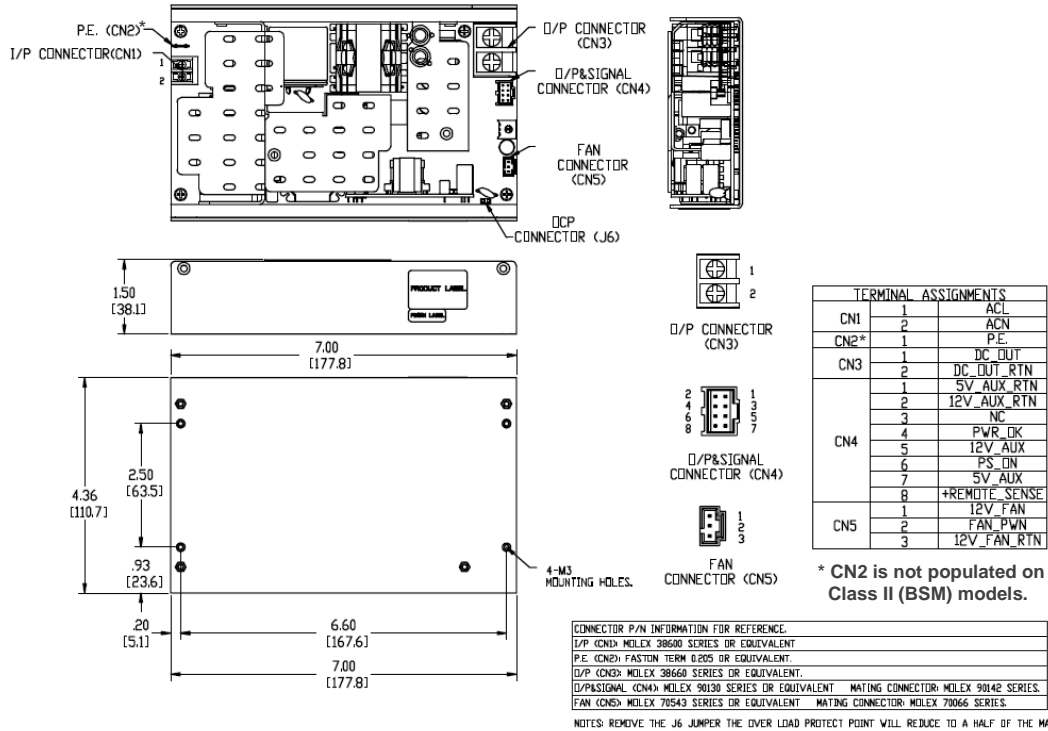

TERMINAL ASSIGNMENTS		
CN1	1	ACL
	2	ACN
CN2*	1	P.E.
	2	DC_OUT
CN3	1	DC_OUT_RTN
	2	5V_AUX_RTN
	3	12V_AUX_RTN
	4	NC
	5	PWR_OK
	6	12V_AUX
	7	5V_AUX
	8	+REMOTE_SENSE
CN4	1	12V_FAN
	2	FAN_PWN
	3	12V_FAN_RTN

* CN2 is not populated on Class II (BSM) models.

U-Channel with Headers

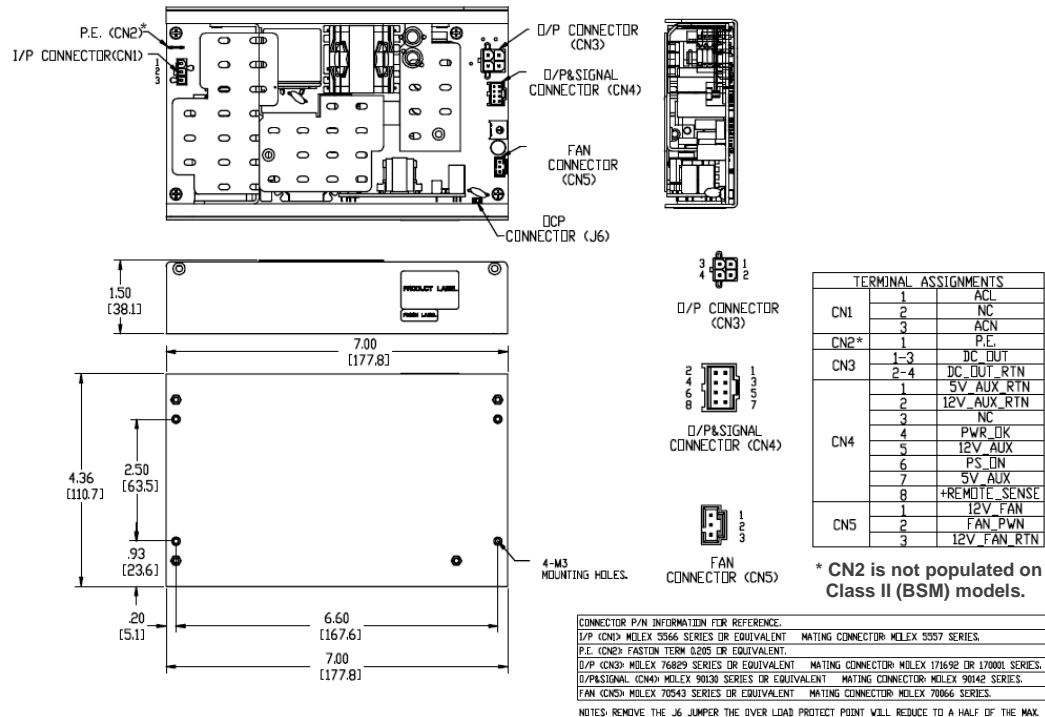

TERMINAL ASSIGNMENTS		
CN1	1	ACL
	2	NC
	3	ACN
CN2*	1	P.E.
	2	DC_OUT
CN3	1-3	DC_OUT_RTN
	2-4	5V_AUX_RTN
	1	12V_AUX_RTN
	2	NC
	3	PWR_OK
	4	12V_AUX
	5	5V_AUX
	6	+REMOTE_SENSE
CN4	1	12V_FAN
	2	FAN_PWN
	3	12V_FAN_RTN

* CN2 is not populated on Class II (BSM) models.

Enclosed with Terminal Blocks

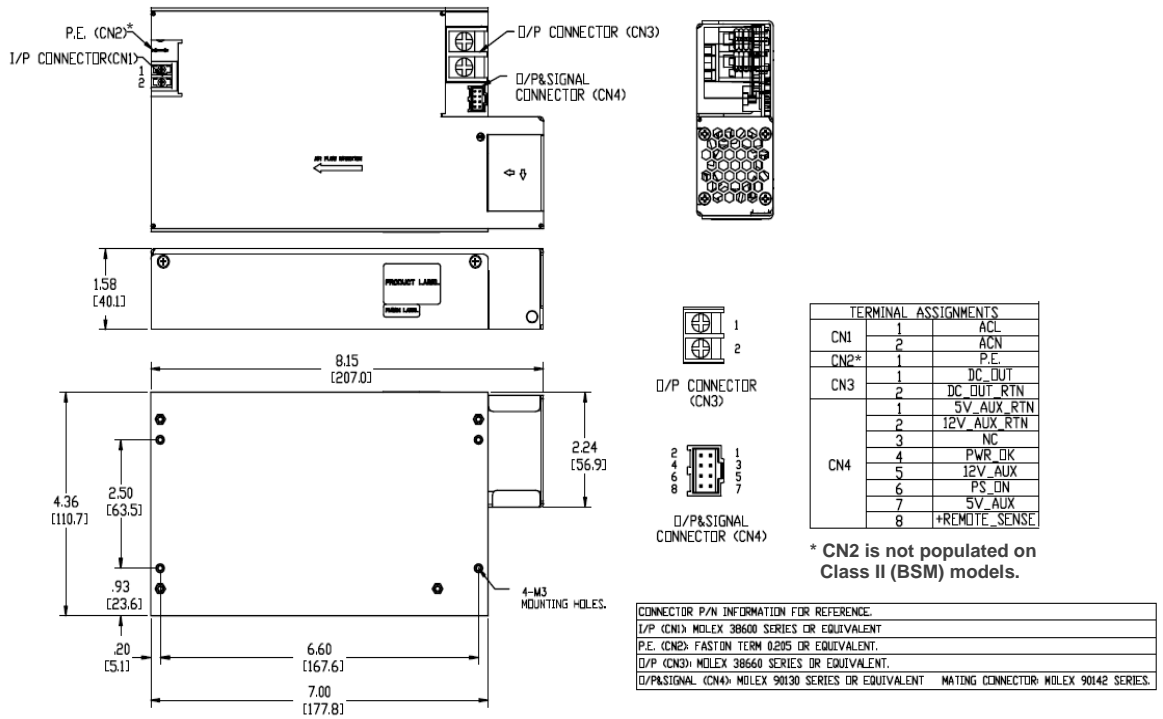

Enclosed with Headers

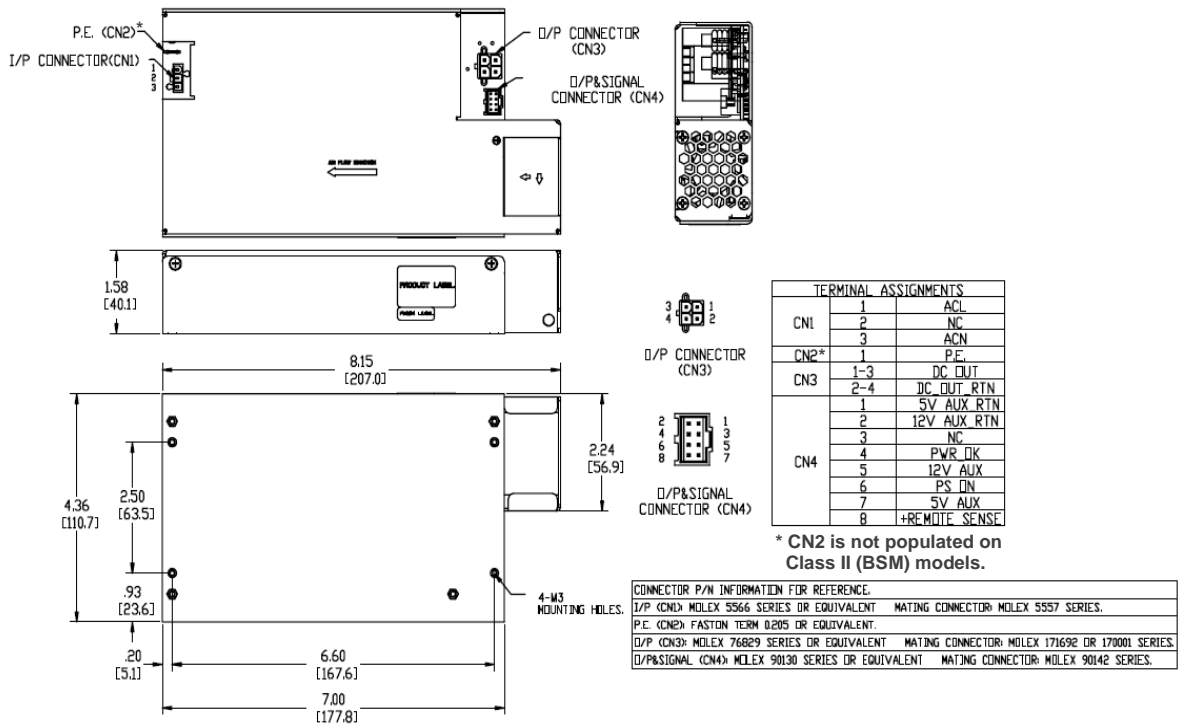

Open-Frame with Headers

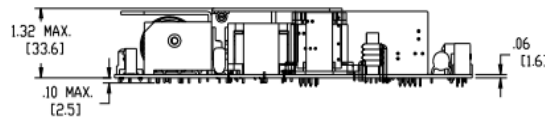
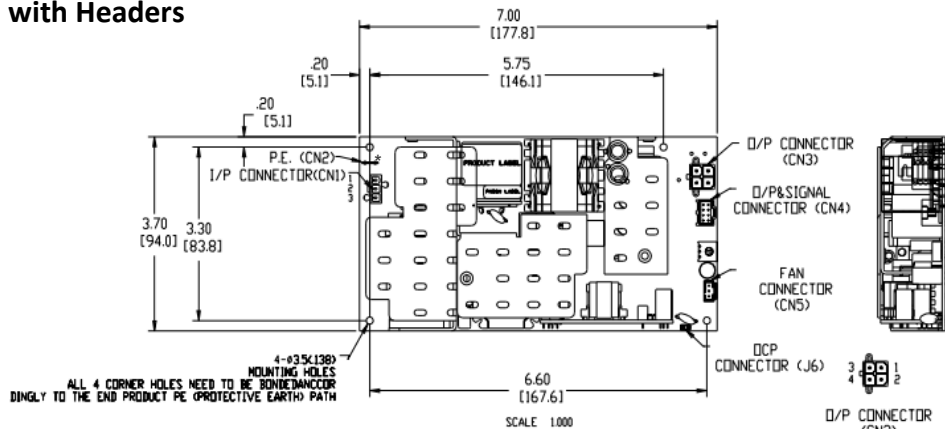

CONNECTOR P/N INFORMATION FOR REFERENCE.	
I/P (CN1)	MOLEX 5566 SERIES OR EQUIVALENT MATING CONNECTOR: MOLEX 5557 SERIES.
P.E. (CN2)	FASTON TERM. 205 SERIES OR EQUIVALENT.
D/P (CN3)	MOLEX 76829 SERIES OR EQUIVALENT MATING CONNECTOR: MOLEX 171692 OR 170001 SERIES.
D/P&SIGNAL (CN4)	MOLEX 90130 SERIES OR EQUIVALENT MATING CONNECTOR: MOLEX 90142 SERIES.
FAN (CN5)	MOLEX 70543 SERIES OR EQUIVALENT MATING CONNECTOR: MOLEX 70066 SERIES.

NOTES: REMOVE THE J6 JUMPER THE OVER LOAD PROTECT POINT WILL REDUCE TO A HALF OF THE MAX.

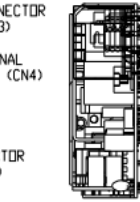

TERMINAL ASSIGNMENTS		
CN1	1	ACL
	2	NC
	3	ACN
CN2	±1	P.E.
	±3	P.E.
CN3	1-3	DC OUT
	2-4	DC OUT RTN
CN4	1	5V_AUX RTN
	2	12V_AUX RTN
	3	NC
	4	PWR_OK
	5	12V_AUX
	6	PS_ON
	7	5V_AUX
	8	+REMOTE_SENSE
CN5	1	12V_FAN
	2	FAN_PWN
	3	12V_FAN_RTN

* CN2 is not populated on Class II (BSM) models.