

Features

- Meet the Requirements of the EIA/TIA-485 Standards with 5V Power Supply
- Integrated Transient Voltage Suppressor (TVS)
- TVS Protection for Bus Terminals :
 $\pm 30\text{ kV}$ IEC 61000-4-2, Contact/Air Discharge
 $\pm 4.4\text{ kV}$ IEC 61000-4-4, EFT (5/50ns)
 $\pm 30\text{ A}$ IEC 61000-4-5, Surge (8/20 μs)
- HBM $\pm 15\text{kV}$ ESD Protection for all pins
- MM $\pm 800\text{V}$ ESD Protection for all pins
- Latchup immunity up to $\pm 400\text{mA}$.
- High CDM protection up to $\pm 2\text{kV}$.
- True Fail-Safe Receiver While Maintaining EIA/TIA-485 Compatibility
- Hot-Swap Glitch free Protection on Control Inputs
- Up to 256 Transceivers on the Bus

Applications

- Motor Control
- Industrial Control
- Telecommunications Equipment
- Security System
- Building Automation Networks

Description

The AZRS6534 is a $\pm 30\text{ kV}$ IEC 61000-4-2 Contact/Air Discharge protected, half-duplex transceiver designed for RS-485 data bus network, which contains one transmitter and one receiver. This device is fully compliant with the EIA/TIA-485 standard with 5V power supply.

The AZRS6534 features a fail-safe receiver, which guarantees the receiver to output high when the receiver inputs are open, short or idle.

The AZRS6534 features a hot-swap glitch free protection circuits which guarantee outputs of both the transmitter and the receiver in a high impedance state during the power up period. So that the large short current from power to ground will be disabled by glitch free function, which will save the power and enhance the efficiency of the power up.

The AZRS6534 has the thermal shutdown function when the temperature is over 150°C and the protection of the current limitation in the transmitter to protect the itself from the damage by the system-fault conditions during normal operation.

The AZRS6534 is also a high reliable device with built-in system level ESD protector device (TVS) against high-energy noise transients without any external components.

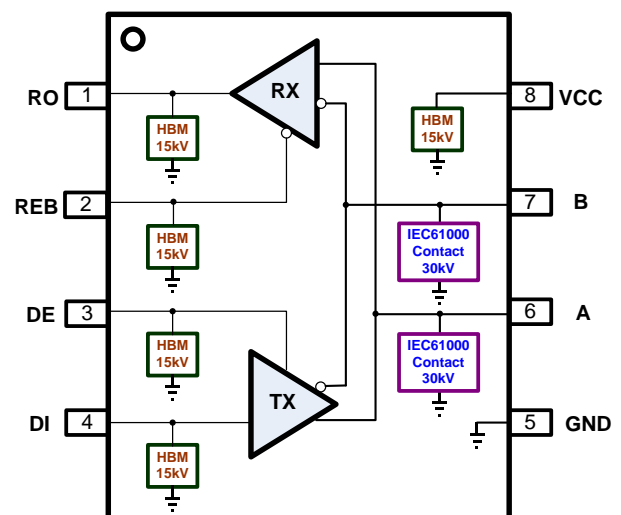

Functional Block of AZRS6534

Part Number	Duplex	Tx/Rx	Supply	Data Rate (Mbps)	Fail-safe	HBM on All pins	IEC 61000-4-5 Surge on A,B	IEC 61000-4-2 Contact on A,B	Package Type
AZRS6534	Half	1/1	5	8	Yes	$\pm 15\text{kV}$	$\pm 30\text{A}$	$\pm 30\text{kV}$	SO-8



ABSOLUTE MAXIMUM RATINGS

PARAMETER	PARAMETER	RATING	UNITS
Power Supply Vcc	Vcc	-0.3 to 8.0	V
Control Input Voltage	REB, DE	-0.3 to (Vcc+ 0.3)	V
Receiver Input Voltage	A, B	± 13	V
Receiver Output Voltage	RO	-0.3 to (Vcc+ 0.3)	V
Transmitter Output Voltage	A, B	± 13	V
Transmitter Input	DI	-0.3 to (Vcc+ 0.3)	V
Operating Temperature	T _{OP}	-40 to +85	°C
Storage Temperature	T _{STO}	-65 to +150	°C

DC ELECTRICAL CHARACTERISTICS

(Vcc=5V $\pm 5\%$ with T_{AMB}= T_{MIN} to T_{MAX}, unless otherwise noted. Typical values are at Vcc=5V and T_{AMB}= 25°C.)

PARAMETER	SYMBOL	CONDITIONS	MIN	TYP	MAX	UNITS
TRANSMITTER						
Differential Transmitter Output	V _{OD1}	No load			Vcc	V
Differential Transmitter Output	V _{OD2}	Fig.1, R _L = 27 Ω	1.7			V
Change in Magnitude of Differential Output Voltage	ΔV_{OD}	Fig.1, R _L = 27 Ω			0.2	V
Transmitter Common- Mode Output Voltage	V _{OC}	Fig.1, R _L = 27 Ω			3.1	V
Change in Magnitude of Common- Mode Voltage	ΔV_{OC}	Fig.1, R _L = 27 Ω			0.2	V
Input High Voltage	V _{IH}	DE, DI, REB	2.0			V
Input Low Voltage	V _{IL}	DE, DI, REB			0.8	V
Input Current	I _{IN1}	DI			± 1	μA
Input Current	I _{IN2}	DE, REB			± 50	μA
DI Input Hysteresis	V _{HYS}			100		mV
Input Current (A and B)	I _{IN3}	DE = GND, VCC = GND or 5.25V	V _{IN} = 12V		125	μA
			V _{IN} = -7V		-75	
Transmitter Short-Circuit Output Current	I _{OS}	$-7\text{V} \leq V_{OUT} \leq V_{CC}$	-250			mA
		$0\text{V} \leq V_{OUT} \leq 12\text{V}$			250	
RECEIVER						
Receiver Differential Threshold Voltage	V _{TH}		-200		-50	mV
Receiver Input Hysteresis	ΔV_{TH}			25		mV
Receiver Output High Voltage	V _{OH}	I _o = -4mA, VID= -50mV	Vcc-1.5			V
Receiver Output Low Voltage	V _{OL}	I _o = 4mA, VID= -200mV			0.4	V
Three- State Output Current at Receiver	I _{OZR}	$0\text{V} \leq V_{RO} \leq V_{CC}$			± 1	μA
Receiver Input Resistance	R _{IN}	$-7\text{V} \leq V_{CM} \leq +12\text{V}$	96			k Ω
Receiver Output Short-Circuit Current	I _{OSR}	Fig.6 , $0\text{V} \leq V_{RO} \leq V_{CC}$	± 7		± 95	mA

PARAMETER	SYMBOL	CONDITIONS	MIN	TYP	MAX	UNITS	
SUPPLY CURRENT							
Supply Current	I _{CC}	No load, REB=GND, DI=V _{CC} or GND.	DE=V _{CC}		420	800	μA
			DE=GND		320	600	μA

SWITCHING CHARACTERISTICS

(V_{CC}=5V $\pm 5\%$ with T_{AMB}= T_{MIN} to T_{MAX}, unless otherwise noted. Typical values are at V_{CC}=5V and T_{AMB}= 25°C.)

PARAMETER	SYMBOL	CONDITIONS	MIN	TYP	MAX	UNITS
Transmitter Input to Output	t _{DPLH} , t _{DPHL}	Fig.2 and 7, R _{DIFF} =54 Ω , C _{L1} =C _{L2} = 100pF		35	60	ns
Transmitter Output Skew $ t_{DPLH} - t_{DPHL} $	t _{DSKEW}	Fig.2 and 7, R _{DIFF} =54 Ω , C _{L1} =C _{L2} = 100pF		5	± 10	ns
Transmitter Rise or Fall Time	t _{DF} , t _{DR}	Fig.2 and 7, R _{DIFF} =54 Ω , C _{L1} =C _{L2} = 100pF		15	25	ns
Maximum Data Rate	f _{MAX}			8		Mbps
Transmitter Enable to Output Low	t _{DZL}	Fig.4 and 8, C _{DL} = 100pF, S1 closed			150	ns
Transmitter Enable to Output High	t _{DZH}	Fig.4 and 8, C _{DL} = 100pF, S2 closed			150	ns
Transmitter Disable Time from Low	t _{DLZ}	Fig.4 and 8, C _{DL} = 15pF, S1 closed			100	ns
Transmitter Disable Time from High	t _{DHZ}	Fig.4 and 8, C _{DL} = 15pF, S2 closed			100	ns
Receiver Input to Output	t _{RPLH} , t _{RPHL}	Fig.5 and 9, $ V_{ID} \geq 2.0\text{V}$; rise and fall time of V _{ID} \leq 15ns		200	230	ns
$ t_{RPLH} - t_{RPHL} $ Different Receiver Skew	t _{RSKD}	Fig.5 and 9, $ V_{ID} \geq 2.0\text{V}$; rise and fall time of V _{ID} \leq 15ns		20		ns
Receiver Enable to Output Low	t _{RZL}	Fig.3 and 10, C _R L= 100pF, S1 closed		20	50	ns
Receiver Enable to Output High	t _{RZH}	Fig.3 and 10, C _R L= 100pF, S2 closed		20	50	ns
Receiver Disable Time from Low	t _{RLZ}	Fig.3 and 10, C _R L= 100pF, S1 closed		20	50	ns
Receiver Disable Time from High	t _{RHZ}	Fig.3 and 10, C _R L= 100pF, S2 closed		20	50	ns



PIN FUNCTION DESCRIPTION

Pin Number	Mnemonic	Function
1	RO	Receiver Output: When REB is low and if $(A - B) \geq -50\text{mV}$, RO is high; if $(A - B) \leq -200\text{mV}$, RO is low.
2	REB	Receiver Output Enable: REB is low to enable the Receiver; REB is high to disable the Receiver.
3	DE	Transmitter Output Enable: DE is high to enable the transmitter; DE is low to disable the transceiver.
4	DI	Transmitter Input: When DE is high, a low on DI forces A output low and B output high. Similarly, a high on DI forces A output high and B output low.
5	GND	Ground pin. Must be connected to 0V.
6	A	Non-inverting Receiver Input and Non-inverting Transmitter Output
7	B	Inverting Receiver Input and Inverting Transmitter Output
8	VCC	Power Supply Input 5V.

FUNCTION TABLE

TRANSMITTING				
INPUTS			OUTPUTS	
REB	DE	DI	A	B
X	1	0	0	1
X	1	1	1	0
X	0	X	HIGH- Z	HIGH- Z

X= Don't care

HIGH- Z= High impedance

RECEIVING			
INPUTS			OUTPUTS
REB	DE	A - B	RO
0	0	$\geq -0.05\text{V}$	1
0	0	$\leq -0.2\text{V}$	0
0	0	Open/Shorted	1
1	X	X	HIGH- Z

X= Don't care

HIGH- Z= High impedance

($V_{CC} = +5\text{V}$, $T_{AMB} = 25^\circ\text{C}$, unless otherwise noted.)

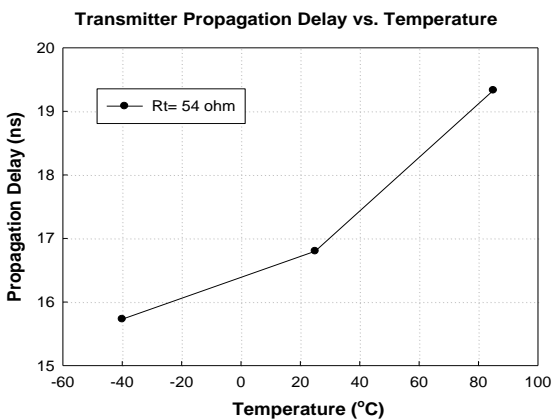
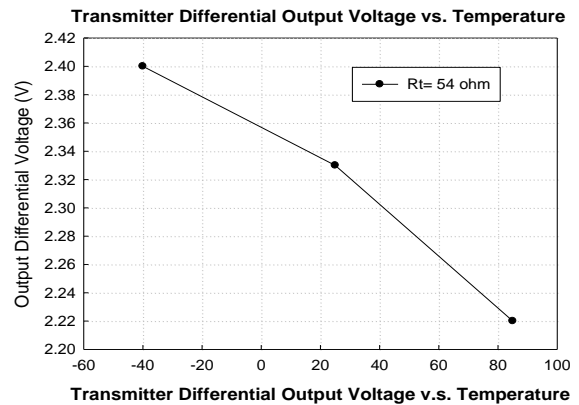
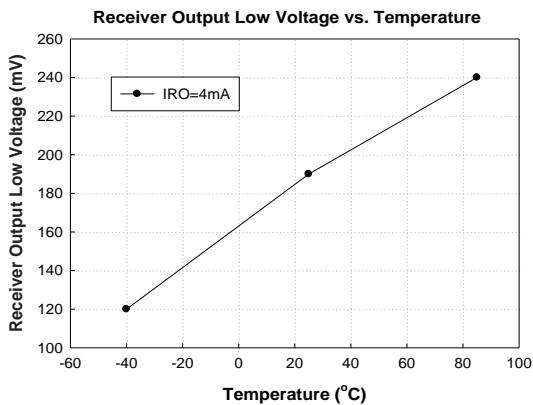
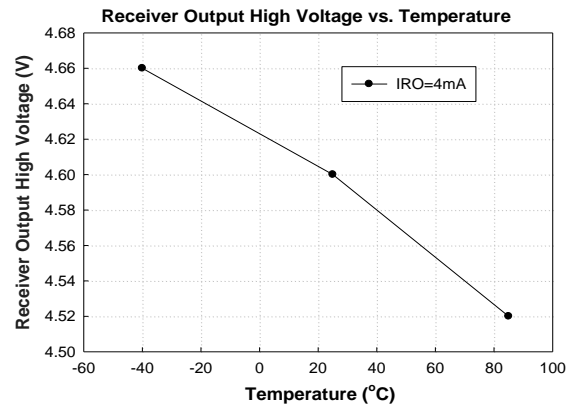
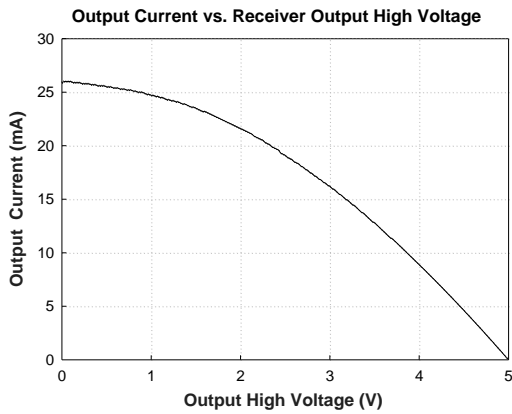
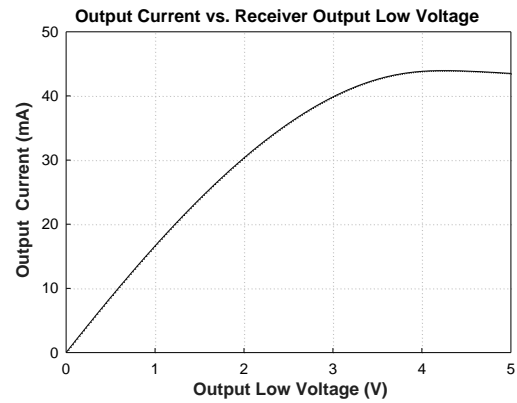
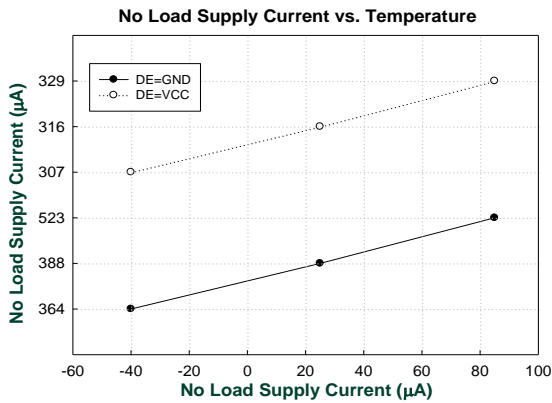

Detail Description

The AZRS6534 is a half-duplex RS-485 transceiver, which contains one transmitter and one receiver with 5V power supply. This device is fully compliant with the EIA/TIA-485 standard.

The AZRS6534 features a fail-safe receiver, which guarantees the receiver output high when the receiver inputs are open, short or idle. This is the true fail-safe receiver, which can save both the external pull-high off-chip resistor on bus A and pull-low off-chip resistor on bus B.

The AZRS6534 features the hot-swap circuit which guarantees the outputs of both the transmitter and receiver in a high impedance state during the power-up period until the supply voltage has stabilized.

The AZRS6534 has the thermal shutdown function and the current limited protection in the transmitter to protect the device from damage by system fault conditions during normal operation.

The immunity of the latchup is up to $\pm 400\text{mA}$ that will enhance the system to be more safety and reliable.

Transmitter

The design of the transmitter is a non-inverted translator that converts the TTL single-ended input signal to differential EIA/TIA-485 signal level. The transmitter of the AZRS6534 guarantees a 8Mbps data rate communication. When the transmitter is active (DE= HIGH), the single-end input signals of transmitter will be transported to differential output signals of the transmitter. Under the disable state (DE= LOW), the outputs of transmitter are stay at high impedance state. The driving ability of the transmitter is referred to the differential output voltage under loading condition, which meets the EIA/TIA 485 standard. The fully differential output of transmitter is connected to the differential input of the receiver due to half-duplex operation.

Receiver

The receiver of the AZRS6534 converts the differential EIA/TIA-485 signals to single-end output TTL signal when receiver is in active state (REB=LOW), which incorporates input filtering in addition to input hysteresis, which enhances noise immunity with differential signals that have very slow rise and fall times.

Fail-Safe

The AZRS6534 guarantees a receiver output high when the receiver inputs are short, open, or idle. The threshold voltage of receiver input is between -50mV and -200mV . If the differential receiver input voltage (A - B) is greater than or equal to -50mV , receiver output (RO) is logic-high. If (A - B) is less than or equal to -200mV , RO is logic-low. In the case of a terminated bus with all transmitters disabled, the receiver's differential input voltage (A - B) is 0V; therefore, the RO is logic-high at that time.

Transmitter Output Protection

The AZRS6534 has the current limitation function and the thermal shutdown protection in the transmitter. Firstly, the function of current limitation provides immediate protection against short circuits over the whole common-mode voltage range (-7V to $+12\text{V}$). Secondly, the function of thermal shutdown protection will be active to force the transmitter outputs into a high impedance state if the operating temperature is over 150°C .

1/8 Unit Load

The RS-485 standard defines both receiver inputs impedance are $12\text{k}\Omega$ (1 unit load) and the maximum 32-unit loads on the bus. The AZRS6534 transceiver has a $96\text{k}\Omega$ input impedance (1/8 unit load) of the receiver, allowing up to 256 devices to be connected in parallel on the RS485 bus.

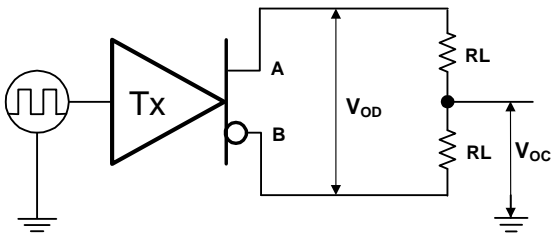

Fig.1 Transmitter DC test circuit

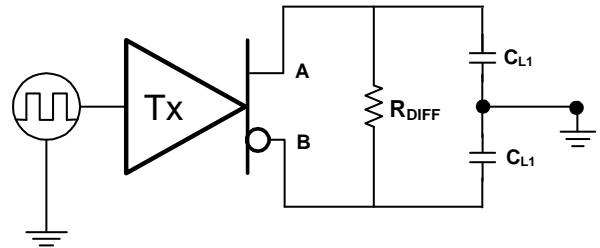

Fig.2 Transmitter timing test circuit

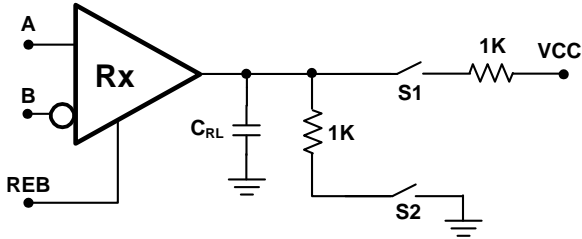

Fig.3 Receiver enable/disable timing test load

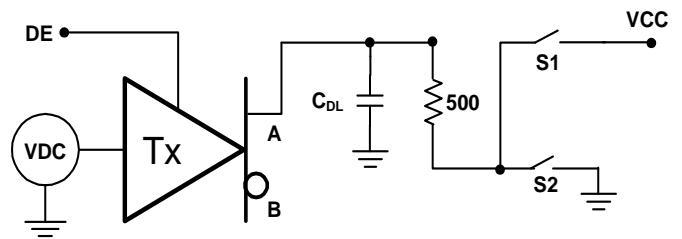

Fig.4 Transmitter enable/disable timing test load

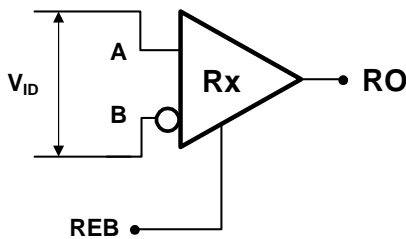

Fig.5 Receiver timing test circuit

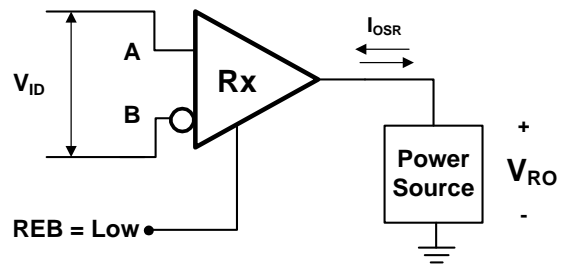

Fig.6 Receiver output short circuit

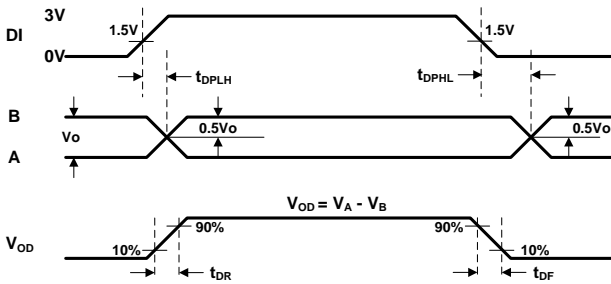

Fig.7 Transmitter Propagation Delays

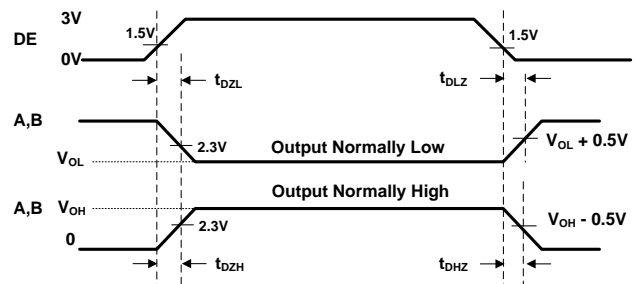

Fig.8 Transmitter Enable and Disable Times

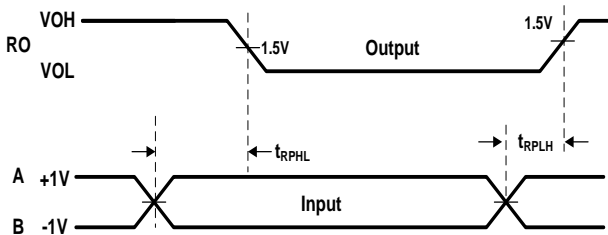

Fig.9 Receiver Propagation Delays

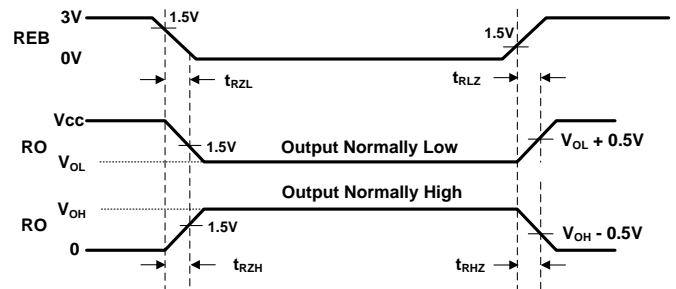
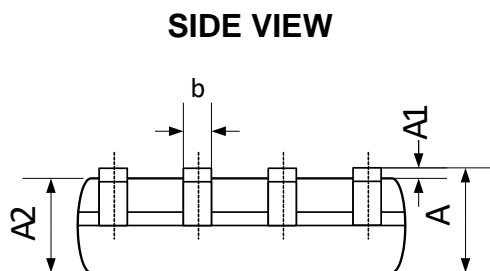
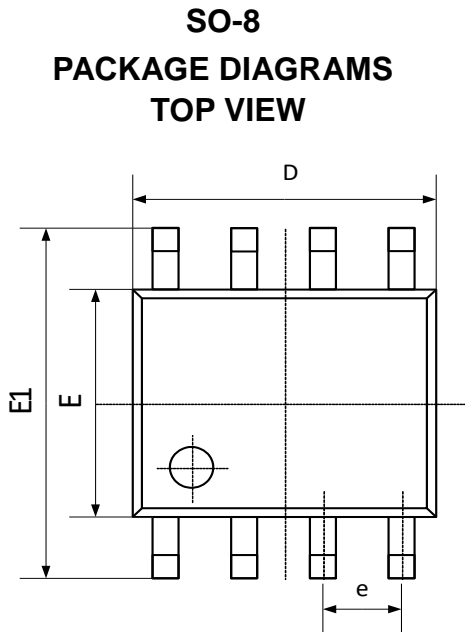
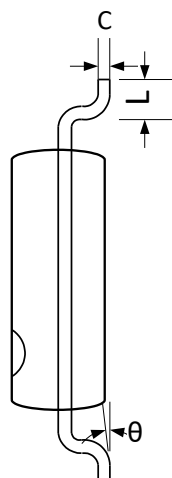

Fig.10 Receiver Enable and Disable Times

Mechanical Details



END VIEW



PACKAGE DIMENSIONS

Symbol	Millimeters		Inches	
	min	max	min	max
A	1.35	1.75	0.053	0.069
A1	0.10	0.25	0.004	0.010
A2	1.35	1.55	0.053	0.061
b	0.33	0.51	0.013	0.020
C	0.17	0.26	0.007	0.010
D	4.70	5.10	0.185	0.201
E	3.70	4.10	0.146	0.161
E1	5.80	6.20	0.228	0.244
e	1.27 BSC		0.05BSC	
L	0.40	1.27	0.016	0.050
Θ	0	8	0	8

MARKING CODE

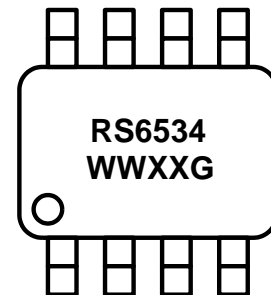

RS6534 = Device Code
WW = Date Code
XX = Control Code
G = Green Part Indication

Part Number	Marking Code
AZRS6534.RDG	RS6534 WWXXG



Ordering Information

PN#	Material	Type	Reel size	MOQ/interal box	MOQ/carton
AZRS6534.RDG	Green	T/R	13 inch	1 reel=2,500/box	5 boxes=12,500/carton

Revision History

Revision	Modification Description
Revision 2019/05/31	The Formal Release.