

## 1. Features and Benefits

- Wide operating voltage range: from 2.7V to 24V
- Integrated self-diagnostic functions activating dedicated Safe Mode
- Reverse supply voltage protection
- Under-Voltage Lockout protection
- Integrated capacitor for PCB less designs
- HW component Qualified according to ISO26262-8:13 for use in safety critical systems.

## 2. Application Examples

- Automotive, Consumer and Industrial
- Brake light switch
- Window lifter
- Door lock
- Seatbelt buckle
- Seat positioning
- Transmission applications
- Electrical power steering

## 3. Ordering Information

Product Code	Temperature Code	Package Code	Option Code	Packing form Code
MLX92221	L	UA	BAA-0xx	BU
MLX92221	L	SE	BAA-0xx	RE
MLX92221	L	UA	BAA-1xx	BU
MLX92221	L	SE	BAA-2xx	RE
MLX92221	L	UA	BAA-3xx	BU

**Legend:**

Temperature Code: L(-40°C to 150°C)  
Package Code: UA = TO92-3L | SE = TSOT-3L  
Option Code: 0xx => Perpendicular sensitive  
1xx => Integrated capacitor (UA package only)  
2xx => IMC (SE package only)  
3xx => Integrated capacitor and IMC (UA package only)  
Packing Form: BU = Bulk | RE = Reel | CA=Papertape in Ammopack | CR=Papertape on Reel  
Ordering example: MLX92221LUA-BAA-xxx-BU

## 4. Functional Diagram

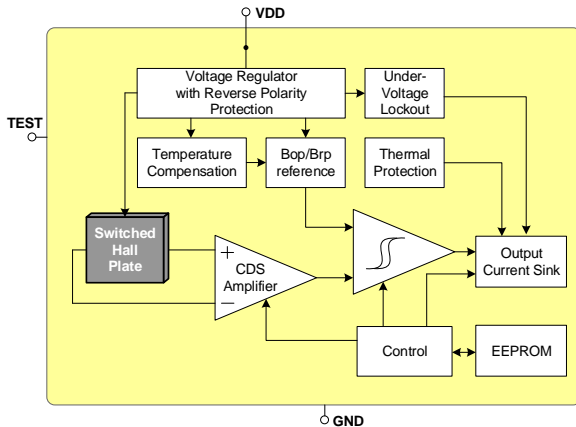

## 5. General Description

The Melexis MLX92221 is based on the Melexis Hall-effect latest platform, designed in mixed signal submicron CMOS technology.

The device integrates a voltage regulator, Hall sensor with advanced offset cancellation system and a current sink-configured output driver and integrated capacitor all in a single package.

Based on the proven in use platform, the magnetic core is using an improved offset cancellation system allowing faster and more accurate processing while being temperature insensitive and stress independent. In addition a pre-programmable temperature coefficient is implemented to compensate the natural behavior of certain types of magnets becoming weaker with rise in temperature.

The included voltage regulator operates from 2.7 to 24V, hence covering a wide range of applications. With the built-in reverse voltage protection, a serial resistor or diode on the supply line is not required so that even remote sensors can be specified for low voltage operation down to 2.7V while being reverse voltage tolerant.

In an event of a drop below the minimum supply voltage during operation, the under-voltage lock-out protection will automatically freeze the device, preventing the electrical perturbation to affect the magnetic measurement circuitry. The output current state is therefore only updated based on a proper and accurate magnetic measurement result.

The two-wire interface not only saves one wire, but also allows implementation of diagnostic functions as reverse polarity connection and malfunction detection.

The on-chip thermal protection also switches off the output if the junction temperature increases above an abnormally high threshold. It will automatically recover once the temperature decreases below a safe value.

The MLX92221 is delivered in a Green and RoHS compliant Plastic Single-in-Line (TO-92) for through-hole mount, or PCB-less design with integrated capacitor or in 3-pin Thin Small Outline Transistor (TSOT) for surface mount process.

## Contents

<b>1. Features and Benefits</b> .....	<b>1</b>
<b>2. Application Examples</b> .....	<b>1</b>
<b>3. Ordering Information</b> .....	<b>1</b>
<b>4. Functional Diagram</b> .....	<b>2</b>
<b>5. General Description</b> .....	<b>2</b>
<b>6. Glossary of Terms</b> .....	<b>4</b>
<b>7. Absolute Maximum Ratings</b> .....	<b>4</b>
<b>8. General Electrical Specifications</b> .....	<b>5</b>
<b>9. Magnetic Specifications</b> .....	<b>6</b>
9.1. MLX92221LSE-BAA-008 .....	6
9.2. MLX92221LUA-BAA-012 .....	6
9.3. MLX92221LUA-BAA-013 .....	6
9.4. MLX92221LUA-BAA-101 .....	6
9.5. MLX92221LUA-BAA-102 .....	7
9.6. MLX92221LUA-BAA-103 .....	7
9.7. MLX92221LUA-BAA-105 .....	7
9.8. MLX92221LUA-BAA-107 .....	7
9.9. MLX92221LSE-BAA-201 .....	8
9.10. MLX92221LSE-BAA-202 .....	8
<b>10. Magnetic Behavior</b> .....	<b>10</b>
<b>11. Application Information</b> .....	<b>10</b>
11.1. Typical Automotive Application Circuit.....	10
11.2. Automotive and Harsh, Noisy Environments Application Circuit .....	10
11.3. Power Derating Curve .....	11
11.4. Voltage Derating Curve .....	11
<b>12. Standard information regarding manufacturability of Melexis products</b> .....	<b>12</b>
<b>13. ESD Precautions</b> .....	<b>12</b>
<b>14. Package Information</b> .....	<b>13</b>
14.1. TSOT-3L (SE Package) .....	13
14.2. TO92-3L (UA Package).....	15
<b>15. Contact</b> .....	<b>17</b>
<b>16. Disclaimer</b> .....	<b>17</b>

## 6. Glossary of Terms

Tesla	Units for the magnetic flux density, 1 mT = 10 Gauss
TC	Temperature Coefficient in ppm/°C
NC	Not Connected
POR	Power on Reset
IMC	integrated magnetic concentrator (lateral sensing)

## 7. Absolute Maximum Ratings

Parameter	Symbol	Value	Units
Supply Voltage <sup>(1, 2)</sup>	V <sub>DD</sub>	+28	V
Supply Voltage (Load Dump) <sup>(1, 4)</sup>	V <sub>DD</sub>	+32	V
Supply Current <sup>(1, 2, 3)</sup>	I <sub>DD</sub>	+20	mA
Supply Current <sup>(1, 3, 4)</sup>	I <sub>DD</sub>	+50	mA
Reverse Supply Voltage <sup>(1, 2)</sup>	V <sub>DDREV</sub>	-24	V
Reverse Supply Voltage <sup>(1, 4)</sup>	V <sub>DDREV</sub>	-30	V
Reverse Supply Current <sup>(1, 2, 5)</sup>	I <sub>DDREV</sub>	-20	mA
Reverse Supply Current <sup>(1, 4, 5)</sup>	I <sub>DDREV</sub>	-50	mA
Maximum Junction Temperature <sup>(6)</sup>	T <sub>J</sub>	+165	°C
ESD Sensitivity – HBM <sup>(7)</sup>	-	8	kV
ESD Sensitivity – System level <sup>(8)</sup>	-	15	kV
ESD Sensitivity – CDM <sup>(9)</sup>	-	1000	V
Magnetic Flux Density	B	Unlimited	mT

Exceeding the absolute maximum ratings may cause permanent damage. Exposure to absolute maximum rated conditions for extended periods may affect device reliability.

<sup>1</sup> The maximum junction temperature should not be exceeded

<sup>2</sup> For maximum 1 hour

<sup>3</sup> Including current through protection device

<sup>4</sup> For maximum 500ms

<sup>5</sup> Through protection device

<sup>6</sup> For 1000 hours.

<sup>7</sup> Human Model according AEC-Q100-002 standard

<sup>8</sup> Indirect discharge according VW TL82466 standard, typical value, only for option MLX92221LUA-BAA-1xx

<sup>9</sup> Charged Device Model according AEC-Q100-011 standard

## 8. General Electrical Specifications

DC Operating Parameters  $V_{DD} = 2.7V$  to  $24V$ ,  $T_J = -40^{\circ}C$  to  $165^{\circ}C$  (unless otherwise specified)

Parameter	Symbol	Test Conditions	Min	Typ <sup>(1)</sup>	Max	Units
OFF Supply Current (selectable by a dedicated bit)	$I_{OFF}$	$V_{DD} = 3.5$ to $24V$	2	-	5	mA
			5	-	6.9	mA
ON Supply Current	$I_{ON}$	$V_{DD} = 3.5$ to $24V$	12	-	17	mA
Reverse Supply current	$I_{DDREV}$	$V_{DD} = -16V$	-1	-	-	mA
Safe Mode Supply Current	$I_{SAFE}$		-	-	1	mA
Supply Current Rise/Fall Time <sup>(2)</sup>	$t_R/t_F$	$V_{DD} = 12V$ , $C_{LOAD} = 50pF$ to GND	0.1	0.3	1	$\mu s$
Power-On Time <sup>(3, 4)</sup>	$t_{ON}$	$V_{DD} = 5V$ , $dV_{DD}/dt > 2V/\mu s$ , activated output with $>1mT$ overdrive	-	40	70	$\mu s$
Chopping Frequency	$f_{CHOP}$		-	350	-	kHz
Delay Time <sup>(2, 5)</sup>	$t_D$	Average over 1000 successive switching events @10kHz, Latch, $B_{OP}$ set to 5mT, triangle wave magnetic field with $B > \pm 20mT$	-	7.5	-	$\mu s$
Output Jitter (p-p) <sup>(2, 6)</sup>	$t_{JITTER}$	Over 1000 successive switching events @10kHz, Latch, $B_{OP}$ set to 5mT, triangle wave magnetic field with $B > \pm 20mT$	-	$\pm 3.5$	-	$\mu s$
Maximum Switching Frequency <sup>(2, 7)</sup>	$f_{SW}$	Latch, $B_{OP}$ set to 5mT, triangle wave magnetic field with $B > \pm 20mT$	-	50	-	kHz
Under-voltage Lockout Threshold	$V_{UVL}$		-	-	2.7	V
Under-voltage Lockout Reaction time <sup>(2)</sup>	$t_{UVL}$		-	1	-	$\mu s$
Integrated bypass capacitor	$C_{BP}$	Only for option MLX92221LUA- BAA-1xx	-	68	-	nF
Thermal Protection Activation	$T_{PROT}$	Junction Temperature	-	190 <sup>(8)</sup>	-	$^{\circ}C$
Thermal Protection Release	$T_{REL}$	Junction Temperature	-	180 <sup>(8)</sup>	-	$^{\circ}C$
UA Package Thermal Resistance	$R_{THJA}$	Single layer PCB, JEDEC standard test boards	-	200	-	$^{\circ}C/W$
SE Package Thermal Resistance	$R_{THJA}$	Single layer PCB, JEDEC standard test boards	-	300	-	$^{\circ}C/W$

1 Typical values are defined at  $T_A = 25^{\circ}C$  and  $V_{DD} = 12V$

2 Guaranteed by design and verified by characterization, not production tested

3 The Power-On Time represents the time from reaching  $V_{DD} = 2.7V$  to the first refresh of the supply current state

4 Power-On Slew Rate is not critical for the proper device start-up

5 The Delay Time is the time from magnetic threshold reached to the start of the output switching

6 Output jitter is the unpredictable deviation of the Delay time.

7 Maximum switching frequency corresponds to the maximum frequency of the applied magnetic field which is detected without loss of pulses

8  $T_{PROT}$  and  $T_{REL}$  are the corresponding junction temperature values

## 9. Magnetic Specifications

### 9.1. MLX92221LSE-BAA-008

DC Operating Parameters  $V_{DD} = 3.5V$  to  $24V$ ,  $T_J = -40^{\circ}C$  to  $165^{\circ}C$

Test Condition	Operating Point $B_{OP}$ (mT) <sup>(3)</sup>			Release Point $B_{RP}$ (mT) <sup>(3)</sup>			TC (ppm/°C)	I <sub>off</sub> (mA)	Active Pole	Package Information
	Min	Typ <sup>(1)</sup>	Max	Min	Typ <sup>(1)</sup>	Max				
$T_J = -40^{\circ}C$	2.1	4	5.9	-5.9	-4	-2.1	0 <sup>(2)</sup>	3.3	Z-axis sensitive South pole	TSOT-3L
$T_J = 25^{\circ}C$	2.3	4	5.7	-5.7	-4	-2.3				
$T_J = 150^{\circ}C$	2.1	4	5.9	-5.9	-4	-2.1				

### 9.2. MLX92221LUA-BAA-012

DC Operating Parameters  $V_{DD} = 3.5V$  to  $24V$ ,  $T_J = -40^{\circ}C$  to  $165^{\circ}C$

Test Condition	Operating Point $B_{OP}$ (mT) <sup>(3)</sup>			Release Point $B_{RP}$ (mT) <sup>(3)</sup>			TC (ppm/°C)	I <sub>off</sub> (mA)	Active Pole	Package Information
	Min	Typ <sup>(1)</sup>	Max	Min	Typ <sup>(1)</sup>	Max				
$T_J = -40^{\circ}C$	2.9	4.6	6.4	-6.4	-4.6	-2.9	-2000 <sup>(2)</sup>	6	Z-axis sensitive South pole	UA (TO92-3)
$T_J = 25^{\circ}C$	2.5	4.0	5.5	-5.5	-4.0	-2.5				
$T_J = 150^{\circ}C$	1.4	3.0	4.7	-4.7	-3.0	-1.4				

### 9.3. MLX92221LUA-BAA-013

DC Operating Parameters  $V_{DD} = 3.5V$  to  $24V$ ,  $T_J = -40^{\circ}C$  to  $165^{\circ}C$

Test Condition	Operating Point $B_{OP}$ (mT) <sup>(3)</sup>			Release Point $B_{RP}$ (mT) <sup>(3)</sup>			TC (ppm/°C)	I <sub>off</sub> (mA)	Active Pole	Package Information
	Min	Typ <sup>(1)</sup>	Max	Min	Typ <sup>(1)</sup>	Max				
$T_J = -40^{\circ}C$	1.9	3.9	5.8	-5.8	-3.9	-1.9	-1100 <sup>(2)</sup>	3.3	Z-axis sensitive South pole	UA (TO92-3)
$T_J = 25^{\circ}C$	1.6	3.5	5.4	-5.4	-3.5	-1.6				
$T_J = 150^{\circ}C$	1.1	3	5	-5	-3	-1.1				

### 9.4. MLX92221LUA-BAA-101

DC Operating Parameters  $V_{DD} = 3.5V$  to  $24V$ ,  $T_J = -40^{\circ}C$  to  $165^{\circ}C$

Test Condition	Operating Point $B_{OP}$ (mT) <sup>(3)</sup>			Release Point $B_{RP}$ (mT) <sup>(3)</sup>			TC (ppm/°C)	I <sub>off</sub> (mA)	Active Pole	Package Information
	Min	Typ <sup>(1)</sup>	Max	Min	Typ <sup>(1)</sup>	Max				
$T_J = -40^{\circ}C$	5	10.5	17	-17	-10.5	-5	-400 <sup>(2)</sup>	3.3	Z-axis sensitive South pole	UA (TO92-3)
$T_J = 25^{\circ}C$	5	10	17	-17	-10	-5				
$T_J = 150^{\circ}C$	5	9.5	17	-17	-9.5	-5				

<sup>1</sup> Typical values are defined at  $T_A = +25^{\circ}C$  and  $V_{DD} = 12V$

<sup>2</sup> Temperature coefficient is calculated using the following formula:

$$\frac{(B_{OPT2} - B_{RPT2}) - (B_{OPT1} - B_{RPT1})}{(B_{OP25^{\circ}C} - B_{RP25^{\circ}C}) \times (T_2 - T_1)} * 10^6, ppm/^{\circ}C; T_1 = 25^{\circ}C; T_2 = 150^{\circ}C$$

<sup>3</sup> Final magnetic parameters will be covered in the PPAP documentation set, the table below is based on theoretical calculations

### 9.5. MLX92221LUA-BAA-102

DC Operating Parameters  $V_{DD} = 3.5V$  to  $24V$ ,  $T_J = -40^{\circ}C$  to  $165^{\circ}C$

Test Condition	Operating Point $B_{OP}$ (mT)			Release Point $B_{RP}$ (mT)			TC (ppm/ $^{\circ}C$ )	Ioff (mA)	Active Pole	Package Information
	Min	Typ <sup>(1)</sup>	Max	Min	Typ <sup>(1)</sup>	Max				
$T_J = -40^{\circ}C$	4.1	6.8	9.6	-9.6	-6.8	-4.1	-2000 <sup>(2)</sup>	6	Z-axis sensitive South pole	UA (TO92-3)
$T_J = 25^{\circ}C$	4.1	6	7.9	-7.9	-6	-4.1				
$T_J = 150^{\circ}C$	1.8	4.5	7.1	-7.1	-4.5	-1.8				

### 9.6. MLX92221LUA-BAA-103

DC Operating Parameters  $V_{DD} = 3.5V$  to  $24V$ ,  $T_J = -40^{\circ}C$  to  $165^{\circ}C$

Test Condition	Operating Point $B_{OP}$ (mT)			Release Point $B_{RP}$ (mT)			TC (ppm/ $^{\circ}C$ )	Ioff (mA)	Active Pole	Package Information
	Min	Typ <sup>(1)</sup>	Max	Min	Typ <sup>(1)</sup>	Max				
$T_J = -40^{\circ}C$	2.4	5.4	8.4	-8.4	-5.4	-2.4	-1100 <sup>(2)</sup>	3.3	Z-axis sensitive South pole	UA (TO92-3)
$T_J = 25^{\circ}C$	3	5	7	-7	-5	-3				
$T_J = 150^{\circ}C$	1.6	4.3	7	-7	-4.3	-1.6				

### 9.7. MLX92221LUA-BAA-105

DC Operating Parameters  $V_{DD} = 3.5V$  to  $24V$ ,  $T_J = -40^{\circ}C$  to  $165^{\circ}C$

Test Condition	Operating Point $B_{OP}$ (mT)			Release Point $B_{RP}$ (mT)			TC (ppm/ $^{\circ}C$ )	Ioff (mA)	Active Pole	Package Information
	Min	Typ <sup>(1)</sup>	Max	Min	Typ <sup>(1)</sup>	Max				
$T_J = -40^{\circ}C$	0.5	2	3.2	-3.2	-2	-0.5	0 <sup>(2)</sup>	6	Z-axis sensitive South pole	UA (TO92-3)
$T_J = 25^{\circ}C$	0.8	1.8	2.8	-2.8	-1.8	-0.8				
$T_J = 150^{\circ}C$	0.3	1.8	3.3	-3.3	-1.8	-0.3				

### 9.8. MLX92221LUA-BAA-107

DC Operating Parameters  $V_{DD} = 3.5V$  to  $24V$ ,  $T_J = -40^{\circ}C$  to  $165^{\circ}C$

Test Condition	Operating Point $B_{OP}$ (mT) <sup>(3)</sup>			Release Point $B_{RP}$ (mT) <sup>(3)</sup>			TC (ppm/ $^{\circ}C$ )	Ioff (mA)	Active Pole	Package Information
	Min	Typ <sup>(1)</sup>	Max	Min	Typ <sup>(1)</sup>	Max				
$T_J = -40^{\circ}C$	7.4	11.8	16.3	-16.3	-11.8	-7.4	0 <sup>(2)</sup>	6	Z-axis sensitive South pole	UA (TO92-3)
$T_J = 25^{\circ}C$	7.4	11.8	16.3	-16.3	-11.8	-7.4				
$T_J = 150^{\circ}C$	7.4	11.8	16.3	-16.3	-11.8	-7.4				

<sup>1</sup> Typical values are defined at  $T_A = +25^{\circ}C$  and  $V_{DD} = 12V$

<sup>2</sup> Temperature coefficient is calculated using the following formula:

$$\frac{(B_{OPT2} - B_{RPT2}) - (B_{OPT1} - B_{RPT1})}{(B_{OP25^{\circ}C} - B_{RP25^{\circ}C}) \times (T_2 - T_1)} * 10^6, ppm/^{\circ}C; T_1 = 25^{\circ}C; T_2 = 150^{\circ}C$$

<sup>3</sup> Final magnetic parameters will be covered in the PPAP documentation set, the table below is based on theoretical calculations

### 9.9. MLX92221LSE-BAA-201

DC Operating Parameters  $V_{DD} = 3.5V$  to  $24V$ ,  $T_J = -40^{\circ}C$  to  $165^{\circ}C$

Test Condition	Operating Point $B_{OP}$ (mT) <sup>(3)</sup>			Release Point $B_{RP}$ (mT) <sup>(3)</sup>			TC (ppm/°C)	I <sub>off</sub> (mA)	Active Pole	Package Information
	Min	Typ <sup>(1)</sup>	Max	Min	Typ <sup>(1)</sup>	Max				
$T_J = -40^{\circ}C$	4.6	6.9	9.3	-9.3	-6.9	-4.6	-2000 <sup>(2)</sup>	6	X-axis sensitive South pole	TSOT-3L
$T_J = 25^{\circ}C$	4.0	6.0	8.0	-8.0	-6.0	-4.0				
$T_J = 150^{\circ}C$	2.4	4.5	6.7	-6.7	-4.5	-2.4				

### 9.10. MLX92221LSE-BAA-202

DC Operating Parameters  $V_{DD} = 3.5V$  to  $24V$ ,  $T_J = -40^{\circ}C$  to  $165^{\circ}C$

Test Condition	Operating Point $B_{OP}$ (mT) <sup>(3)</sup>			Release Point $B_{RP}$ (mT) <sup>(3)</sup>			TC (ppm/°C)	I <sub>off</sub> (mA)	Active Pole	Package Information
	Min	Typ <sup>(1)</sup>	Max	Min	Typ <sup>(1)</sup>	Max				
$T_J = -40^{\circ}C$	0.3	1.75	3.2	-3.2	-1.75	-0.3	0 <sup>(2)</sup>	3.3	X-axis sensitive South pole	TSOT-3L
$T_J = 25^{\circ}C$	0.4	1.75	3.1	-3.1	-1.75	-0.4				
$T_J = 150^{\circ}C$	0.3	1.75	3.2	-3.2	-1.75	-0.3				

<sup>1</sup> Typical values are defined at  $T_A = +25^{\circ}C$  and  $V_{DD} = 12V$

<sup>2</sup> Temperature coefficient is calculated using the following formula:

$$\frac{(B_{OPT2} - B_{RPT2}) - (B_{OPT1} - B_{RPT1})}{(B_{OP25^{\circ}C} - B_{RP25^{\circ}C}) \times (T_2 - T_1)} * 10^6, ppm/^{\circ}C; T_1 = 25^{\circ}C; T_2 = 150^{\circ}C$$

<sup>3</sup> Final magnetic parameters will be covered in the PPAP documentation set, the table below is based on theoretical calculations



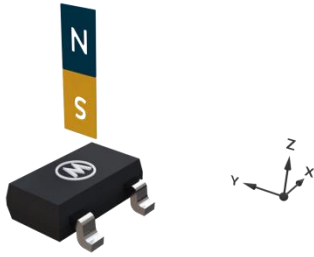

South active pole

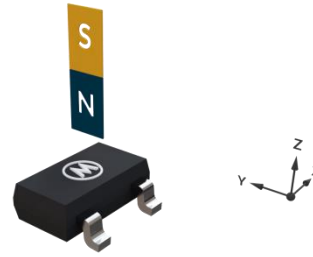

North active pole

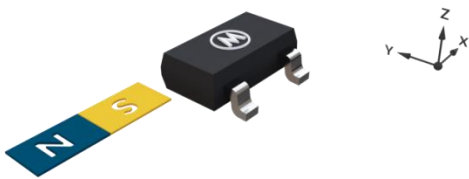

South active pole (IMC version)

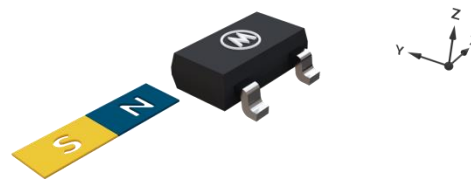

North active pole (IMC version)

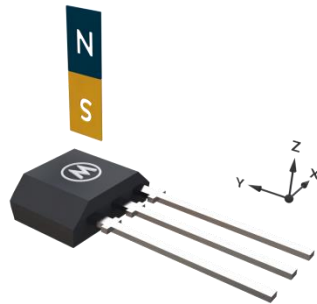

South active pole

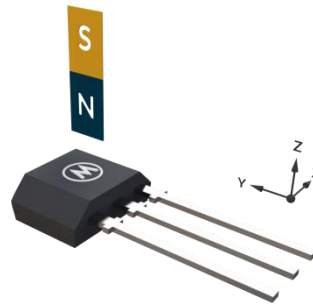

North active pole

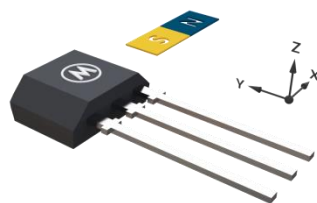

South active pole (IMC version)

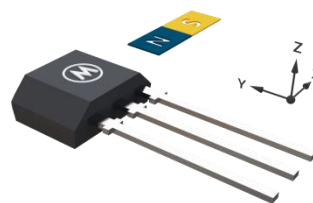

North active pole (IMC version)

## 10. Magnetic Behavior

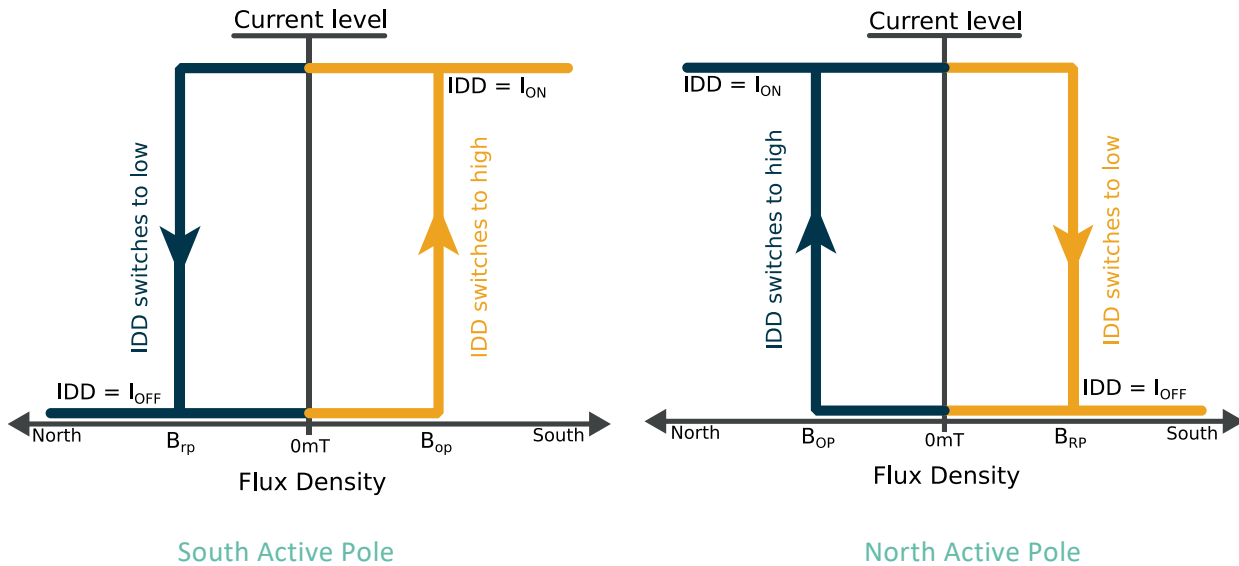

## 11. Application Information

### 11.1. Typical Automotive Application Circuit

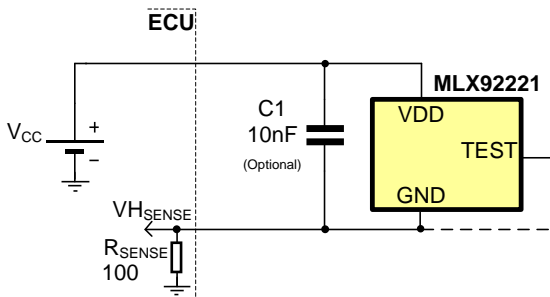

**Notes:**

1. For proper operation, a 10 to 100nF bypass capacitor should be placed as close as possible to the V<sub>DD</sub> and ground (GND) pin. For MLX92221LUA-BAA-1xx C1 is not required.
2. The TEST pin is to be connected to GND or left open.

### 11.2. Automotive and Harsh, Noisy Environments Application Circuit

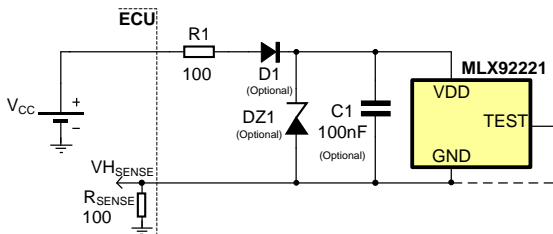

**Notes:**

1. For proper operation, a 10 to 100nF bypass capacitor should be placed as close as possible to the V<sub>DD</sub> and ground (GND) pin. For MLX92221LUA-BAA-1xx C1 is not required.
2. The device can tolerate positive voltages up to +28 (+32)V and negative voltages down to -24 (-30)V. If bigger transients over the supply line are expected the usage of D1 and DZ1 (24...27V) is recommended. The series resistor R1 is used to limit the current through DZ1 and to improve the EMC performance.

### 11.3. Power Derating Curve

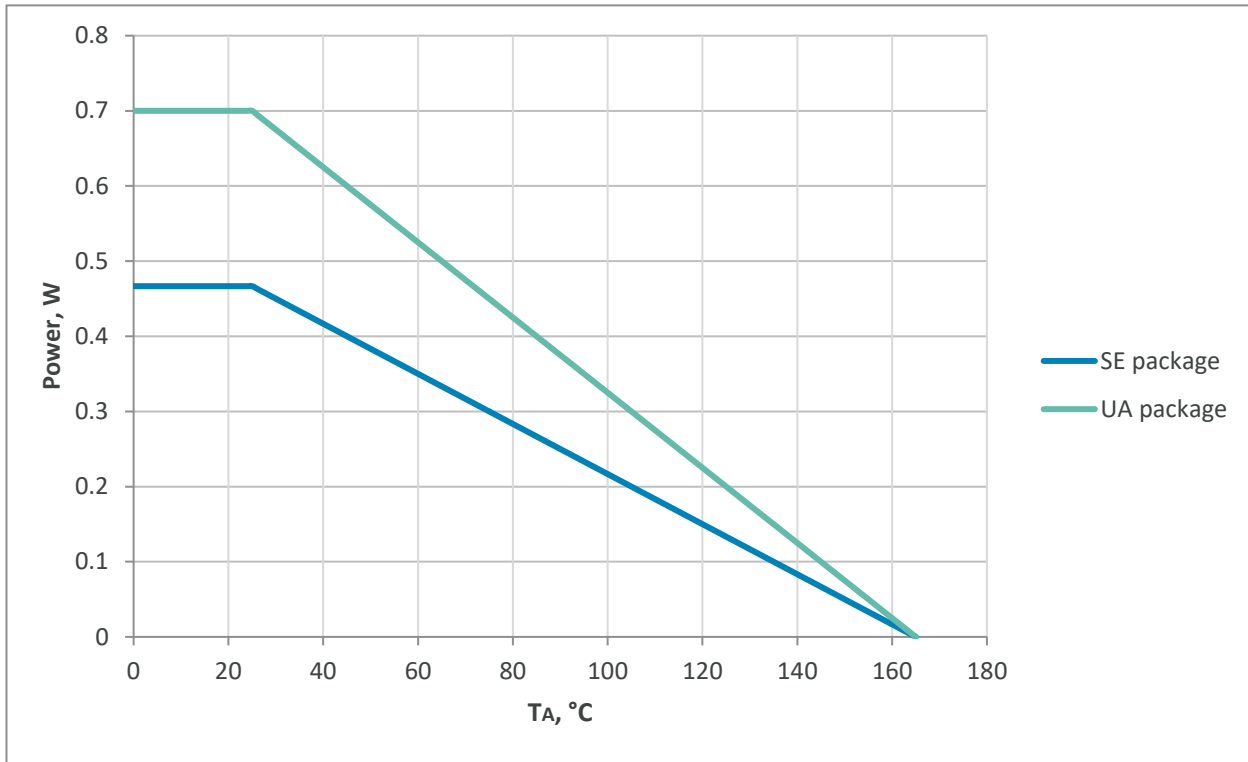

### 11.4. Voltage Derating Curve

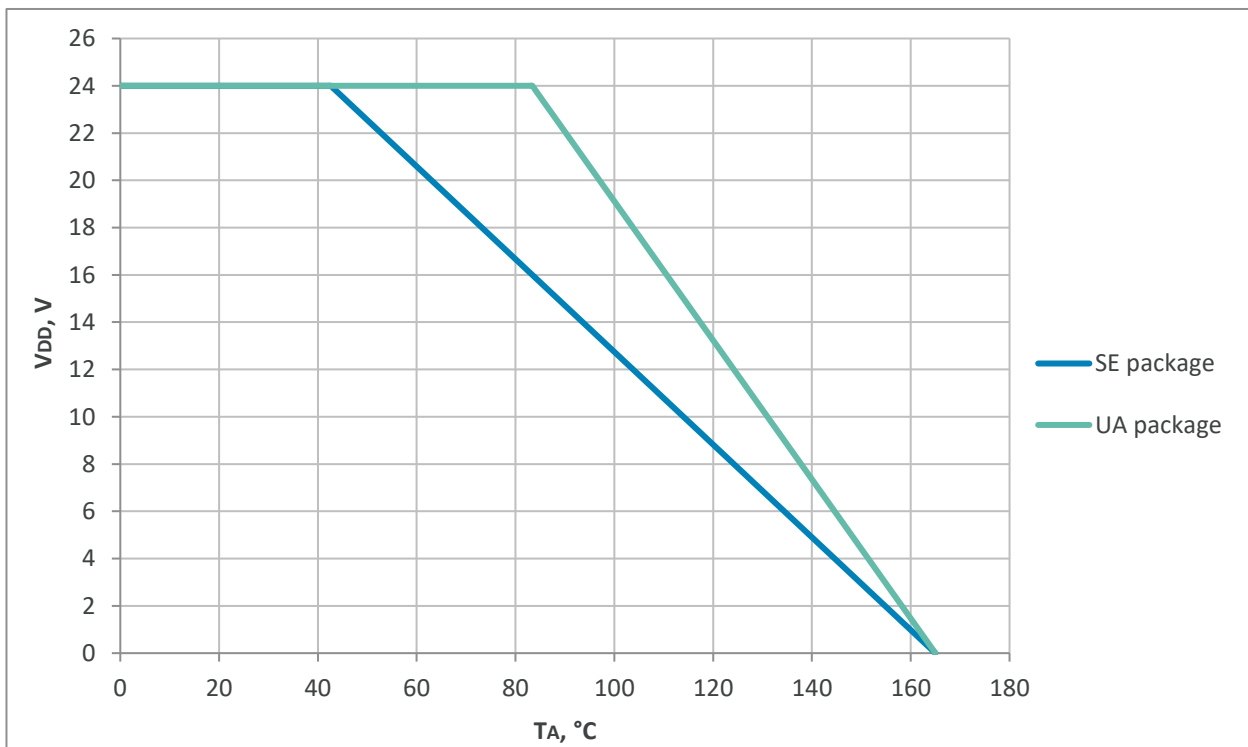

## 12. Standard information regarding manufacturability of Melexis products

Our products are classified and qualified regarding soldering technology, solderability and moisture sensitivity level according to following test methods:

### Reflow Soldering SMD's (Surface Mount Devices)

- IPC/JEDEC J-STD-020  
Moisture/Reflow Sensitivity Classification for Nonhermetic Solid State Surface Mount Devices (classification reflow profiles according to table 5-2)
- EIA/JEDEC JESD22-A113  
Preconditioning of Nonhermetic Surface Mount Devices Prior to Reliability Testing (reflow profiles according to table 2)

### Wave Soldering SMD's (Surface Mount Devices) and THD's (Through Hole Devices)

- EN60749-20  
Resistance of plastic- encapsulated SMD's to combined effect of moisture and soldering heat
- EIA/JEDEC JESD22-B106 and EN60749-15  
Resistance to soldering temperature for through-hole mounted devices

### Iron Soldering THD's (Through Hole Devices)

- EN60749-15  
Resistance to soldering temperature for through-hole mounted devices

### Solderability SMD's (Surface Mount Devices) and THD's (Through Hole Devices)

- EIA/JEDEC JESD22-B102 and EN60749-21  
Solderability

For all soldering technologies deviating from above mentioned standard conditions (regarding peak temperature, temperature gradient, temperature profile etc) additional classification and qualification tests have to be agreed upon with Melexis.

The application of Wave Soldering for SMD's is allowed only after consulting Melexis regarding assurance of adhesive strength between device and board.

Melexis is contributing to global environmental conservation by promoting **lead free** solutions. For more information on qualifications of **RoHS** compliant products (RoHS = European directive on the Restriction Of the use of certain Hazardous Substances) please visit the quality page on our website: <http://www.melexis.com/quality.aspx>

## 13. ESD Precautions

Electronic semiconductor products are sensitive to Electro Static Discharge (ESD).

Always observe Electro Static Discharge control procedures whenever handling semiconductor products.

## 14. Package Information

### 14.1. TSOT-3L (SE Package)

#### 14.1.1. TSOT-3L – Package dimensions

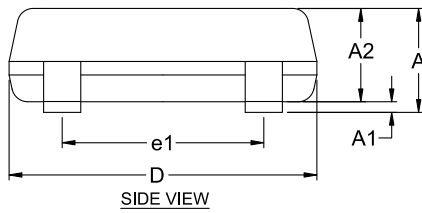
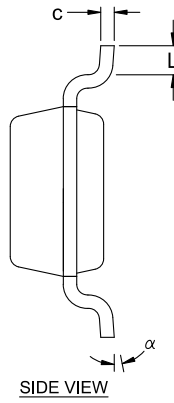
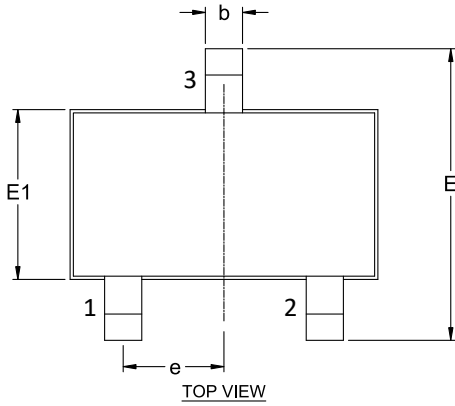

SYMBOL	MINIMUM	MAXIMUM
A	---	1.00
A1	0.025	0.10
A2	0.85	0.90
D	2.80	3.00
E	2.60	3.00
E1	1.50	1.70
L	0.30	0.50
b	0.30	0.45
c	0.10	0.20
e	0.95 BSC	
e1	1.90 BSC	
α	0°	8°

NOTE :

1. ALL DIMENSIONS IN MILLIMETERS (mm) UNLESS OTHERWISE STATED.
2. DIMENSION D DOES NOT INCLUDE MOLD FLASH OR PROTRUSIONS OF MAX 0.15 mm PER SIDE.
3. DIMENSION E DOES NOT INCLUDE MOLD FLASH OR PROTRUSIONS OF MAX 0.25 mm PER SIDE.
4. DIMENSION b DOES NOT INCLUDE DAMBAR PROTRUSION OF MAX 0.07 mm.
5. DIMENSION L IS THE LENGTH OF THE TERMINAL FOR SOLDERING TO A SUBSTRATE.
6. FORMED LEAD SHALL BE PLANAR WITH RESPECT TO ONE ANOTHER WITH 0.076 mm SEATING PLANE.

#### 14.1.2. TSOT-3L – Sensitive spot

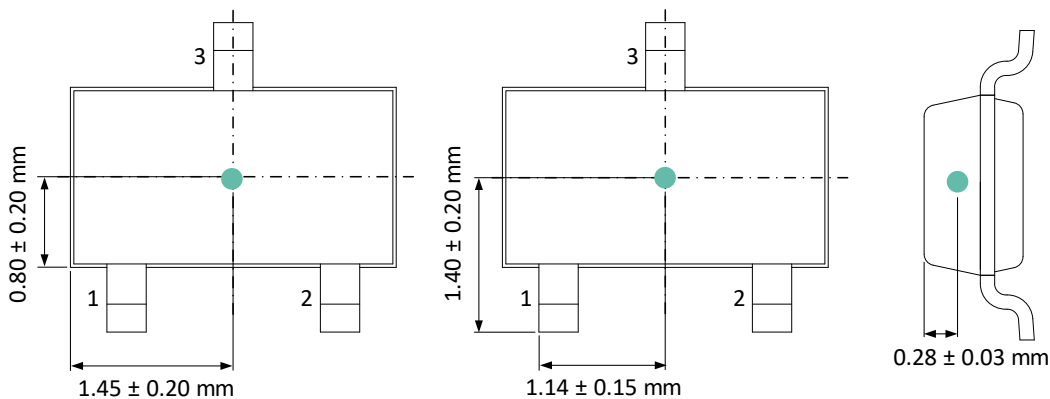

14.1.3. TSOT-3L – Package marking / Pin definition

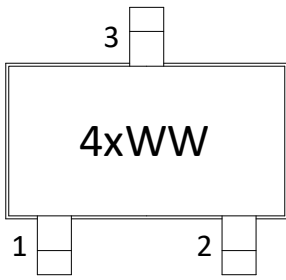

**Top**

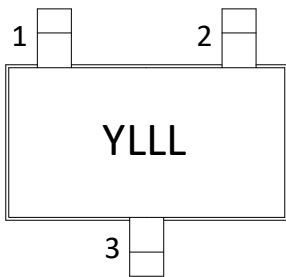
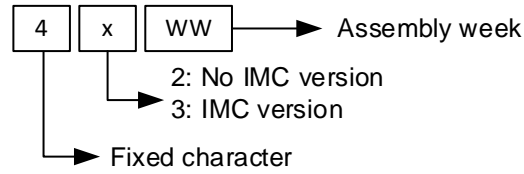

**Bottom**

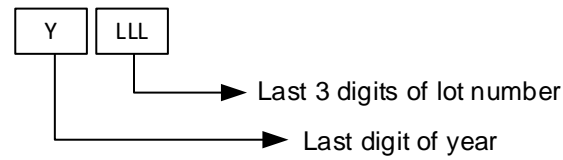

Pin #	Name	Type	Function
1	VDD	Supply	Supply Voltage pin
2	TEST	I/O	For Melexis use only
3	GND	Ground	Ground pin

## 14.2. TO92-3L (UA Package)

### 14.2.1. TO92-3L – Package dimensions

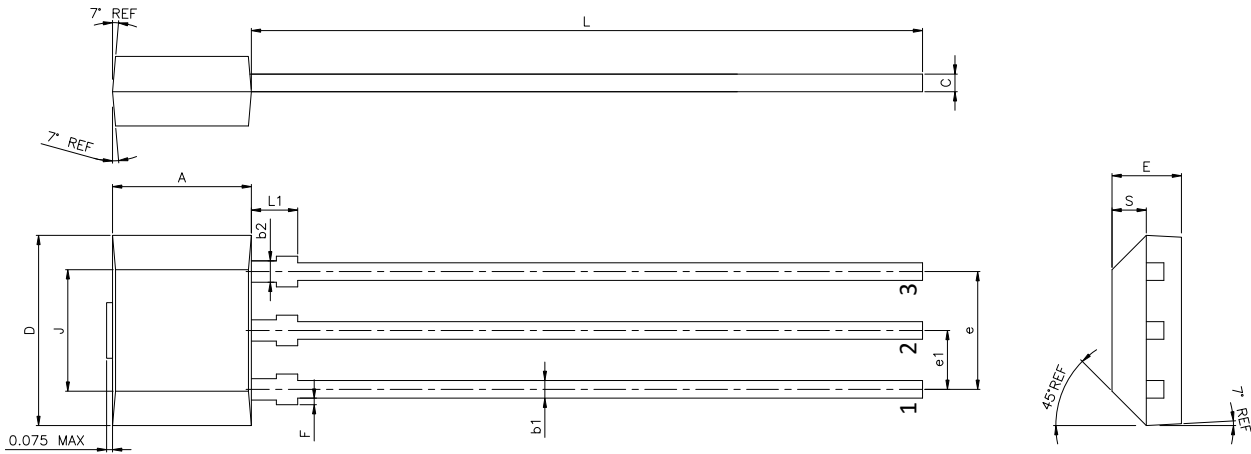

SYMBOL	MINIMUM	MAXIMUM
A	2.90	3.10
D	4.00	4.20
E	1.40	1.60
F	0.00	0.15
J	2.51	2.72
L	14.00	15.00
L1	0.90	1.10
S	0.63	0.84
b1	0.35	0.44
b2	0.43	0.52
c	0.35	0.44
e	2.51	2.57
e1	1.24	1.30

NOTES :

1. DIMENSIONS IN MILLIMETERS (mm) UNLESS NOTED OTHERWISE.
2. PACKAGE DIMENSIONS DO NOT INCLUDE MOLD FLASHES AND PROTRUSIONS.
3. DIMENSION A AND D DO NOT INCLUDE MOLD GATE AND SIDE FLASH (PROTRUSION) of MAXIMUM 0.127 mm PER SIDE.
4. THE LEADS MAY BE SLIGHTLY DEFORMED DURING TRANSPORTATION IF PACKED IN BULK (BAG), AFFECTING e1 DIMENSION. IT IS RECOMMENDED TO ORDER RADIAL TAPE (REEL OR AMMOPACK) IF SUCH DEFORMATION IS CRITICAL FOR THE LEAD FORMING PROCESS, EVEN IF MANUAL LOADING INTO THE TOOL IS FORESEEN.

### 14.2.2. TO92-3L – Sensitive spot

#### Without integrated capacitor (-0xx)

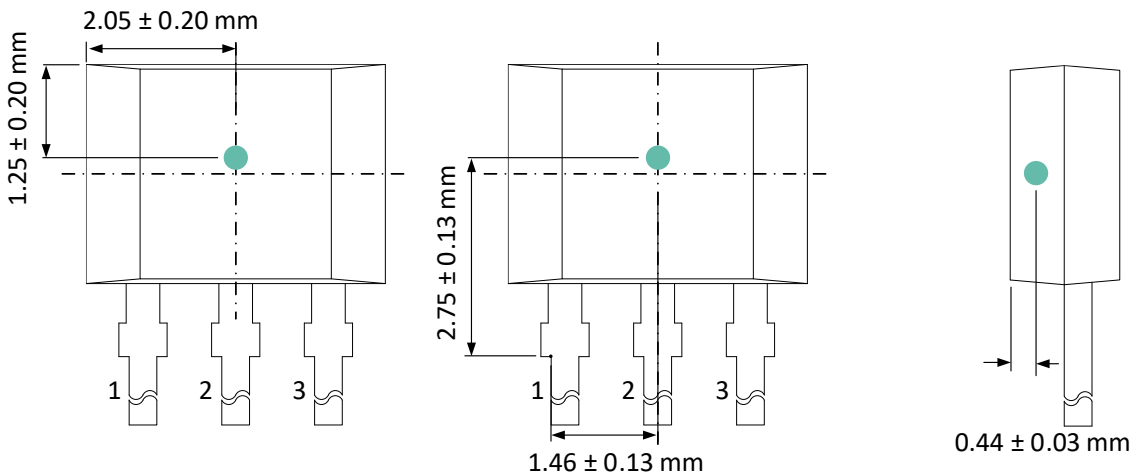

**With integrated capacitor (-1xx, -3xx)**

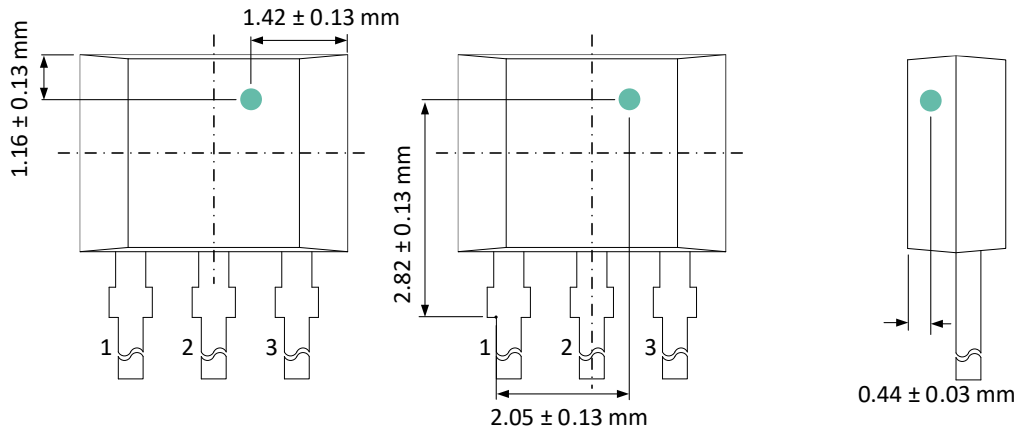

**14.2.3. TO92-3L – Package marking / Pin definition**

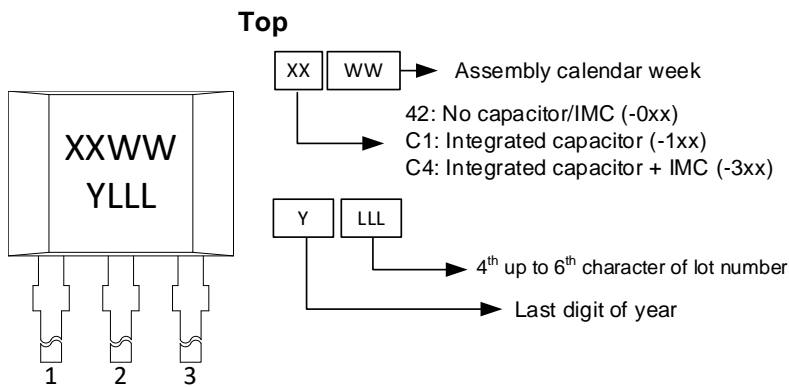

**Without integrated capacitor (-0xx)**

Pin #	Name	Type	Function
1	VDD	Supply	Supply Voltage pin
2	GND	Ground	Ground pin
3	TEST	I/O	For Melexis use only

**With integrated capacitor (-1xx, -3xx)**

Pin #	Name	Type	Function
1	VDD	Supply	Supply Voltage pin
2	TEST	I/O	For Melexis use only
3	GND	Ground	Ground pin



## 15. Contact

For the latest version of this document, go to our website at [www.melexis.com](http://www.melexis.com).

For additional information, please contact our Direct Sales team and get help for your specific needs:

Europe, Africa	
	Email : sales_europe@melexis.com
Americas	
	Email : sales_usa@melexis.com
Asia	Email : sales_asia@melexis.com

## 16. Disclaimer

*The content of this document is believed to be correct and accurate. However, the content of this document is furnished "as is" for informational use only and no representation, nor warranty is provided by Melexis about its accuracy, nor about the results of its implementation. Melexis assumes no responsibility or liability for any errors or inaccuracies that may appear in this document. Customer will follow the practices contained in this document under its sole responsibility. This documentation is in fact provided without warranty, term, or condition of any kind, either implied or expressed, including but not limited to warranties of merchantability, satisfactory quality, non-infringement, and fitness for purpose. Melexis, its employees and agents and its affiliates' and their employees and agents will not be responsible for any loss, however arising, from the use of, or reliance on this document. Notwithstanding the foregoing, contractual obligations expressly undertaken in writing by Melexis prevail over this disclaimer.*

*This document is subject to change without notice, and should not be construed as a commitment by Melexis. Therefore, before placing orders or prior to designing the product into a system, users or any third party should obtain the latest version of the relevant information. Users or any third party must determine the suitability of the product described in this document for its application, including the level of reliability required and determine whether it is fit for a particular purpose.*

*This document as well as the product here described may be subject to export control regulations. Be aware that export might require a prior authorization from competent authorities. The product is not designed, authorized or warranted to be suitable in applications requiring extended temperature range and/or unusual environmental requirements. High reliability applications, such as medical life-support or life-sustaining equipment or avionics application are specifically excluded by Melexis. The product may not be used for the following applications subject to export control regulations: the development, production, processing, operation, maintenance, storage, recognition or proliferation of:*

- 1. chemical, biological or nuclear weapons, or for the development, production, maintenance or storage of missiles for such weapons;*
- 2. civil firearms, including spare parts or ammunition for such arms;*
- 3. defense related products, or other material for military use or for law enforcement;*
- 4. any applications that, alone or in combination with other goods, substances or organisms could cause serious harm to persons or goods and that can be used as a means of violence in an armed conflict or any similar violent situation.*

*No license nor any other right or interest is granted to any of Melexis' or third party's intellectual property rights.*

*If this document is marked "restricted" or with similar words, or if in any case the content of this document is to be reasonably understood as being confidential, the recipient of this document shall not communicate, nor disclose to any third party, any part of the document without Melexis' express written consent. The recipient shall take all necessary measures to apply and preserve the confidential character of the document. In particular, the recipient shall (i) hold document in confidence with at least the same degree of care by which it maintains the confidentiality of its own proprietary and confidential information, but no less than reasonable care; (ii) restrict the disclosure of the document solely to its employees for the purpose for which this document was received, on a strictly need to know basis and providing that such persons to whom the document is disclosed are bound by confidentiality terms substantially similar to those in this disclaimer; (iii) use the document only in connection with the purpose for which this document was received, and reproduce document only to the extent necessary for such purposes; (iv) not use the document for commercial purposes or to the detriment of Melexis or its customers. The confidentiality obligations set forth in this disclaimer will have indefinite duration and in any case they will be effective for no less than 10 years from the receipt of this document.*

*This disclaimer will be governed by and construed in accordance with Belgian law and any disputes relating to this disclaimer will be subject to the exclusive jurisdiction of the courts of Brussels, Belgium.*

*The invalidity or ineffectiveness of any of the provisions of this disclaimer does not affect the validity or effectiveness of the other provisions. The previous versions of this document are repealed.*

*Melexis © - No part of this document may be reproduced without the prior written consent of Melexis. (2022)*

*IATF 16949 and ISO 14001 Certified*