

3-641524-3 ✓ ACTIVE

MTA 156

TE Internal #: 3-641524-3

Rectangular Power Connectors, Connector Assembly, Plug, Wire-to-Wire, 3 Position, 3.96 mm [.156 in] Centerline, Wire & Cable, UL 94V-2, MTA 156

[View on TE.com >](#)



Connectors > Power Connectors > Rectangular Power > Rectangular Power Connectors

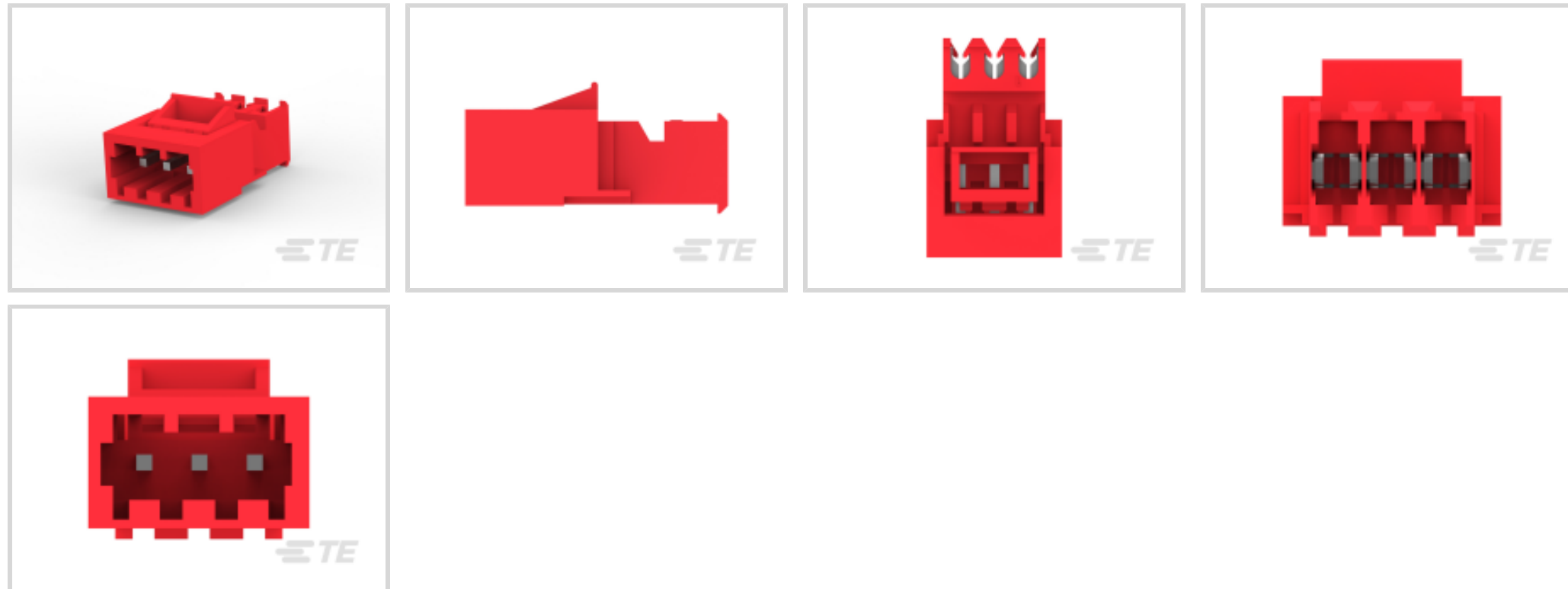

Rectangular Power Connector Type: **Connector Assembly**

Connector & Housing Type: **Plug**

Connector System: **Wire-to-Wire**

Number of Positions: **3**

Centerline (Pitch): **3.96 mm [.156 in]**

## Features

### Product Type Features

Compatible With Discrete Wire Type	Solid, Stranded
Rectangular Power Connector Type	Connector Assembly
Connector & Housing Type	Plug
Connector System	Wire-to-Wire
Sealable	No
Connector & Contact Terminates To	Wire & Cable

### Configuration Features

Number of Positions	3
Number of Power Positions	3
Number of Rows	1

### Electrical Characteristics

Operating Voltage	600 VAC
-------------------	---------

### Body Features

Cable Exit Angle	90°
------------------	-----



Connector Profile	Standard
<b>Contact Features</b>	
Contact Layout	Inline
Contact Underplating Material Thickness	50 µm[1.27 µin]
Wire Contact Termination Area Plating Thickness	2.03 µm[80 µin]
Contact Mating Area Plating Material	Tin
Contact Mating Area Plating Material Finish	Matte
Contact Underplating Material	Nickel
Contact Base Material	Copper Alloy
Contact Current Rating (Max)	7 A
Contact Retention Within Housing	With
Contact Type	Pin
Wire Contact Termination Area Plating Material	Tin
Contact Mating Area Plating Material Thickness	2.03 µm[80 µin]
<b>Termination Features</b>	
Termination Method to Wire & Cable	Insulation Displacement (IDC)
<b>Mechanical Attachment</b>	
Strain Relief	With
Mating Alignment Type	Polarization
Mating Retention	With
Mating Alignment	With
Contact Retention Type Within Housing	Locking Lance
PCB Mount Alignment	Without
Panel Mount Feature	Without
PCB Mount Retention	Without
Mating Retention Type	Latch
Connector Mounting Type	Cable Mount (Free-Hanging)
<b>Housing Features</b>	
Wire & Cable IDC Installation Type	Feed Through
Centerline (Pitch)	3.96 mm[.156 in]
Housing Color	Red
Housing Material	Nylon



### Dimensions

Connector Height	12.37 mm
Product Length	15.85 mm
Compatible Insulation Diameter Range	2.41 mm[.095 in]
Wire Size	.3 – .4 mm <sup>2</sup>

### Usage Conditions

Operating Temperature Range	-55 – 105 °C[-67 – 221 °F]
-----------------------------	----------------------------

### Operation/Application

Circuit Application	Power
---------------------	-------

### Industry Standards

CSA Rating	Certified, LR 7189
UL Rating	Recognized
Agency/Standard	CSA, UL
Approved Standards	UL E28476
UL Flammability Rating	UL 94V-2
Glow Wire Rating	Standard Part - Not Glow Wire

### Packaging Features

Packaging Quantity	2000
Packaging Method	Package

### Product Compliance

[For compliance documentation, visit the product page on TE.com>](#)

EU RoHS Directive 2011/65/EU	Compliant
EU ELV Directive 2000/53/EC	Compliant
China RoHS 2 Directive MIIT Order No 32, 2016	No Restricted Materials Above Threshold
EU REACH Regulation (EC) No. 1907/2006	Current ECHA Candidate List: JUNE 2023 (235) Candidate List Declared Against: JUNE 2023 (235) Does not contain REACH SVHC
Halogen Content	Low Halogen - Br, Cl, F, I < 900 ppm per homogenous material. Also BFR/CFR/PVC Free
Solder Process Capability	Not applicable for solder process capability



Product Compliance Disclaimer

This information is provided based on reasonable inquiry of our suppliers and represents our current actual knowledge based on the information they provided. This information is subject to change. The part numbers that TE has identified as EU RoHS compliant have a maximum concentration of 0.1% by weight in homogenous materials for lead, hexavalent chromium, mercury, PBB, PBDE, DBP, BBP, DEHP, DIBP, and 0.01% for cadmium, or qualify for an exemption to these limits as defined in the Annexes of Directive 2011/65/EU (RoHS2). Finished electrical and electronic equipment products will be CE marked as required by Directive 2011/65/EU. Components may not be CE marked. Additionally, the part numbers that TE has identified as EU ELV compliant have a maximum concentration of 0.1% by weight in homogenous materials for lead, hexavalent chromium, and mercury, and 0.01% for cadmium, or qualify for an exemption to these limits as defined in the Annexes of Directive 2000/53/EC (ELV). Regarding the REACH Regulation, the information TE provides on SVHC in articles for this part number is based on the latest European Chemicals Agency (ECHA) 'Guidance on requirements for substances in articles' posted at this URL: <https://echa.europa.eu/guidance-documents/guidance-on-reach>

## Compatible Parts

 <p>TE Part # CAT-103156-WBHSM Receptacle Housing: Wire-to-Board, with Mating Alignment, SL156</p>	 <p>TE Part # 3-640429-3 03P MTA156 CONN ASSY 24AWG WHT</p>	 <p>TE Part # 3-640427-3 03P MTA156 CONN ASSY 20AWG YEL</p>	 <p>TE Part # 3-640599-3 03P MTA156 CONN ASSY 18AWG ORA</p>
 <p>TE Part # 3-640426-3 03P MTA156 CONN ASSY 18AWG ORA</p>	 <p>TE Part # 3-640600-3 03P MTA156 CONN ASSY 20AWG LF</p>	 <p>TE Part # 643071-3 03P MTA156 FD-THRU COVER</p>	 <p>TE Part # 3-640601-3 03P MTA156 CONN ASSY 22AWG LF</p>
 <p>TE Part # 3-640428-3 03P MTA156 CONN ASSY 22AWG RED</p>	 <p>TE Part # 640551-3 03P MTA156 COVER</p>	 <p>TE Part # 643067-3 03P MTA156 MOLDED COVER</p>	 <p>TE Part # 3-640602-3 03P MTA156 CONN ASSY 24AWG LF</p>



TE Part # 640643-3  
03P MTA156 COVER F/T



TE Part # 3-640430-3  
03P MTA156 CONN ASSY 26AWG BLU



TE Part # 3-644860-3  
03P MTA156 CONN ASSY 18AWG LF



TE Part # 3-640472-3  
03P MTA156 ASSY ON TAPE LF



TE Part # 58040-1  
MTA 156 ARBOR FIXTURE DISCRETE RBN CABLE



TE Part # 58576-1  
MTA 156 PNEUMATIC TOOL FOR BOARD FIXTURE



TE Part # 3-640595-3  
03P MTA156 CONN ASSY 26AWG LF

Also in the Series | **MTA 156**



Insertion & Extraction Tools(1)

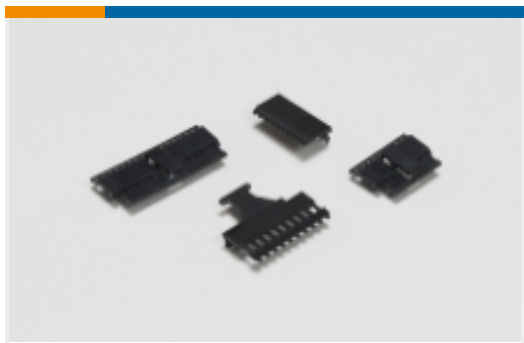

PCB Connector Covers(88)



PCB Connector Keying(2)



PCB Connector Mounting(1)



PCB Headers & Receptacles(314)

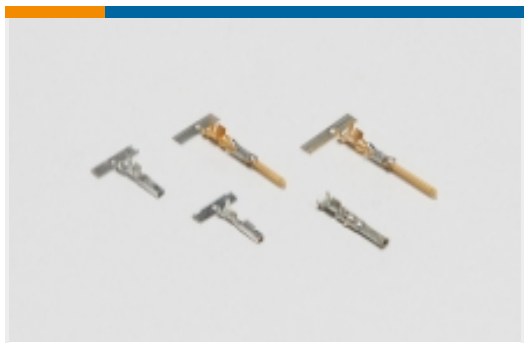

Power Contacts(2)



Rectangular Power Connectors(698)



Standard Rectangular Connectors(337)



Wire-to-Board Connector Contacts(2)

Customers Also Bought



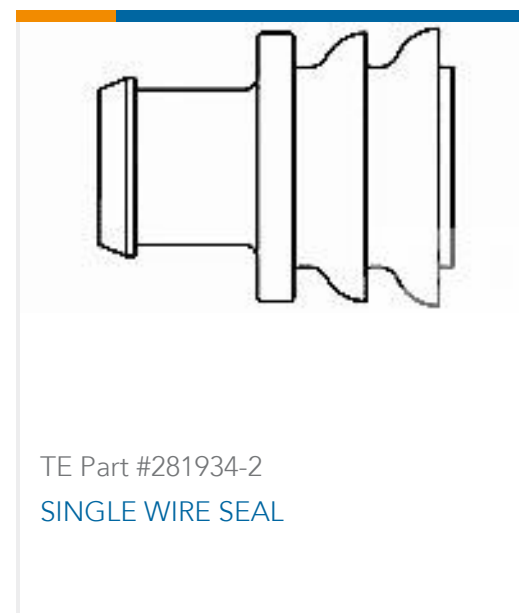

## Documents

### Product Drawings

[03P MTA156 PSTD CONN ASSY LF](#)

English

### CAD Files

[3D PDF](#)

3D

Customer View Model

[ENG\\_CVM\\_CVM\\_3-641524-3\\_K.2d\\_dxf.zip](#)

English

Customer View Model

[ENG\\_CVM\\_CVM\\_3-641524-3\\_K.3d\\_igs.zip](#)

English

Customer View Model

[ENG\\_CVM\\_CVM\\_3-641524-3\\_K.3d\\_stp.zip](#)

English

By downloading the CAD file I accept and agree to the [Terms and Conditions](#) of use.

### Product Specifications

[Application Specification](#)

English

### Agency Approvals

[Agency Approval Document](#)

English