



SPECIFICATIONS

CUSTOMER	:	CDE012
SAMPLE CODE	:	SH480272T009-IHC05
MASS PRODUCTION CODE	:	PH480272T009-IHC05
SAMPLE VERSION	:	01
SPECIFICATIONS EDITION	:	003
DRAWING NO. (Ver.)	:	JLMD-PH480272T009-IHC05_001
PACKAGING NO. (Ver.)	:	JPKG-PH480272T009-IHC05_001

Customer Approved

Date:



Approved	Checked	Designer
閔偉	劉進	楊威

- Preliminary specification for design input
- Specification for sample approval

POWER TIP TECH. CORP.

Headquarters:

No.8, 6th Road, Taichung Industrial Park,
Taichung, Taiwan
台中市 407 工業區六路 8 號

TEL: 886-4-2355-8168
FAX: 886-4-2355-8166

E-mail: sales@powertip.com.tw
[Http://www.powertip.com.tw](http://www.powertip.com.tw)

History of Version

Date (mm / dd / yyyy)	Ver.	Edi.	Description	Page	Design by
02/24/2017	01	001	New Drawing.	-	楊威
05/09/2017	01	002	New Sample	-	楊威
06/20/2017	01	003	Modify Optical Characteristics; Block Diagram; Interface Pin Description	6; 11; 13	楊威

Total: 30 Page

Contents

1. SPECIFICATIONS

- 1.1 Features
- 1.2 Mechanical Specifications
- 1.3 Absolute Maximum Ratings
- 1.4 DC Electrical Characteristics
- 1.5 Optical Characteristics
- 1.6 Backlight Characteristics
- 1.7 Touch Panel Characteristics

2. MODULE STRUCTURE

- 2.1 Counter Drawing
- 2.2 Interface Pin Description
- 2.3 Timing Characteristics

3. QUALITY ASSURANCE SYSTEM

- 3.1 Quality Assurance Flow Chart
- 3.2 Inspection Specification

4. RELIABILITY TEST

- 4.1 Reliability Test Condition

5. PRECAUTION RELATING PRODUCT HANDLING

- 5.1 Safety
- 5.2 Handling
- 5.3 Storage
- 5.4 Terms of Warranty

- Appendix : 1. LCM Drawing
2. LCM Packaging

Note: For detailed information please refer to IC data sheet: ILITEK--- ILI6480B

1. SPECIFICATIONS

1.1 Features

Item	Standard Value
Display Resolution	480*3(RGB) * 272 Dots
LCD Type	a-Si TFT , Normally white , Transmissive type
Screen size(inch)	4.3 inch
Viewing Direction	6 O'clock
Surface treatment	Anti-Glare
Color configuration	R, G, B Vertical Stripe
Backlight Type	White LED B/L
Weight	68.2 g
Interface	24 Bits RGB Interface
Driver IC	ILI6480B
ROHS	THIS PRODUCT CONFORMS THE ROHS OF PTC Detail information please refer website : http://www.powertip.com.tw/news.php?area_id_view=1085560481/

1.2 Mechanical Specifications

Item	Standard Value	Unit
Outline Dimension	113.2(W) x 73.2 (L) x 4.5(H)	mm

LCD panel

Item	Standard Value	Unit
Active Area	95.04 (W) x 53.86 (L)	mm
Pixel Size	0.198 (W) * 0.198 (H)	mm

Note : For detailed information please refer to LCM drawing.

1.3 Absolute Maximum Ratings

Module

Item	Symbol	Condition	Min.	Max.	Unit	Remark
Power Supply Voltage	VDD	GND=0	-0.3	+5.0	V	-
Power Supply Voltage	VCC	GND=0	-0.3	+20.0	V	
Operating Temperature	T _{OP}	-	-20	+70	°C	
Storage Temperature	T _{ST}	-	-30	+80	°C	

The absolute maximum rating values of this product are not allowed to be exceeded at any times. Should a module be used with any of the absolute maximum ratings exceeded, the characteristics of the module may not be recovered, or in an extreme case, the module may be permanently destroyed.

1.4 DC Electrical Characteristics

Module

GND = 0V, Ta = 25°C

Item	Symbol	Condition	Min.	Typ.	Max.	Unit
Power Supply for TFT Panel	VDD	GND=0V	3.0	3.3	3.6	V
Power Supply for Backlight Unit	VCC	GND=0V	5	12	15	V
Input Voltage for TFT Panel	V _{IH}	GND=0V	0.7VDD	-	VDD	V
	V _{IL}	GND=0V	0	-	0.3VDD	
Supply Current for TFT Panel	IDD	IDD@VDD=3.3V	-	23	40	mA
Supply Current for Backlight Unit	ICC	ICC@VCC=5V	-	180	300	
Supply Current for Backlight Unit	ICC	ICC@VCC=12V	-	70	120	
Input Voltage for PWM Signal	V _{PH}	GND=0V	1.2	-	-	V
	V _{PL}	GND=0V	-	-	0.4	V
Dimming Clock Rate	f _P	GND=0V	5	-	100	KHz

1.5 Optical Characteristics

VDD=3.3V, Ta=25°C

Item	Symbol	Condition	Min.	Typ.	Max.	unit	-	
Response time	Tr + Tf	-	-	29	44	ms	Note2	
Viewing angle	Top	$\theta+$	CR \geq 10	-	60	-	Deg.	Note4
	Bottom	$\theta-$		-	60	-		
	Left	θ_L		-	60	-		
	Right	θ_R		-	60	-		
Contrast ratio	CR	-	500	600	-	-	Note3	
Color of CIE Coordinate (LCD & BL & TP)	White	X	VCC=12V PWM="High" (Duty=100%)	0.25	0.30	0.35	-	Note1
		Y		0.27	0.32	0.37		
	Red	X		0.52	0.57	0.62		
		Y		0.28	0.33	0.38		
	Green	X		0.29	0.34	0.39		
		Y		0.55	0.60	0.65		
	Blue	X		0.09	0.15	0.19		
		Y		0.02	0.07	0.12		
Average Brightness Pattern=white display (LCD & BL & TP) *1	IV	VCC=12V PWM="High" (Duty=100%)	680	850	-	cd/m ²		
Uniformity (LCD & BL & TP) *2	ΔB		70	-	-	%		

Note 1:

*1 : $\Delta B = B(\text{min}) / B(\text{max}) * 100\%$

*2 : Measurement Condition for Optical Characteristics:

- a : Environment: $25^{\circ}\text{C} \pm 5^{\circ}\text{C}$ / $60 \pm 20\% \text{R.H}$, no wind , dark room below 10 Lux at typical lamp current and typical operating frequency.
- b : Measurement Distance: $500 \pm 50 \text{ mm}$, ($\theta = 0^{\circ}$)
- c : Equipment: TOPCON BM-7 fast , (field 1°) , after 10 minutes operation.
- d : The uncertainty of the C.I.E coordinate measurement ± 0.01 , Average Brightness $\pm 4\%$

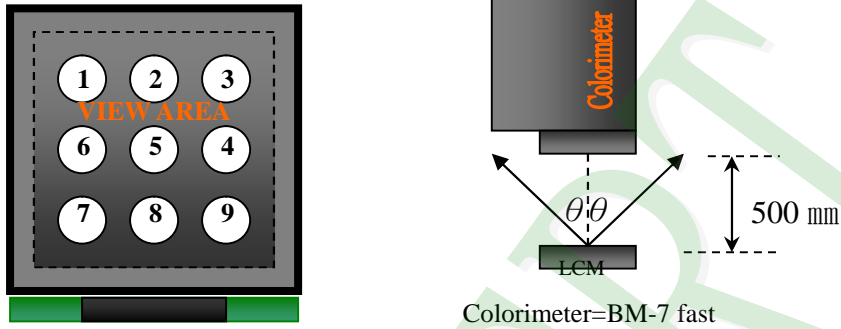

To be measured at the center area of panel with a viewing cone of 1° by Topcon luminance meter BM-7, after 10 minutes operation (module)

Note2: Definition of response time:

The output signals of photo detector are measured when the input signals are changed from "black" to "white"(falling time) and from "white" to "black"(rising time), respectively. The response time is defined as the time interval between the 10% and 90% of Amplitudes.

Refer to figure as below:

Normally White



Normally Black

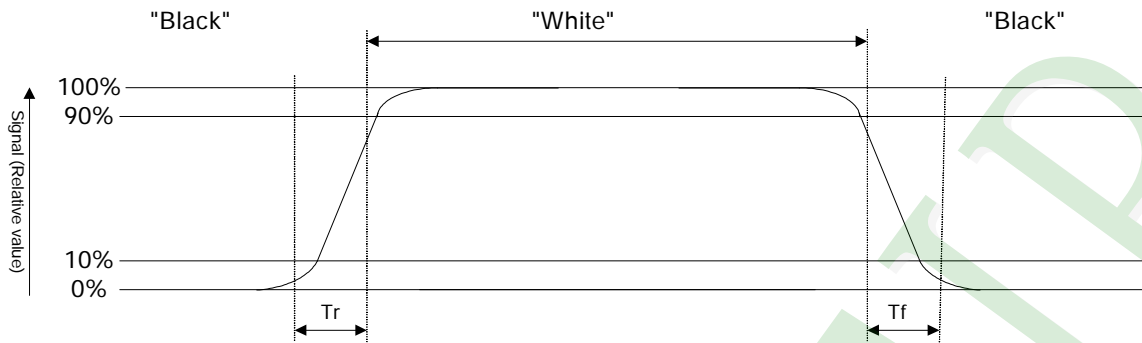

Note3: Definition of contrast ratio:

Contrast ratio is calculated with the following formula

$$\text{Contrast ratio (CR)} = \frac{\text{Photo detector output when LCD is at "White" state}}{\text{Photo detector output when LCD is at "Black" state}}$$

Note4: Definition of viewing angle:

Refer to figure as below:

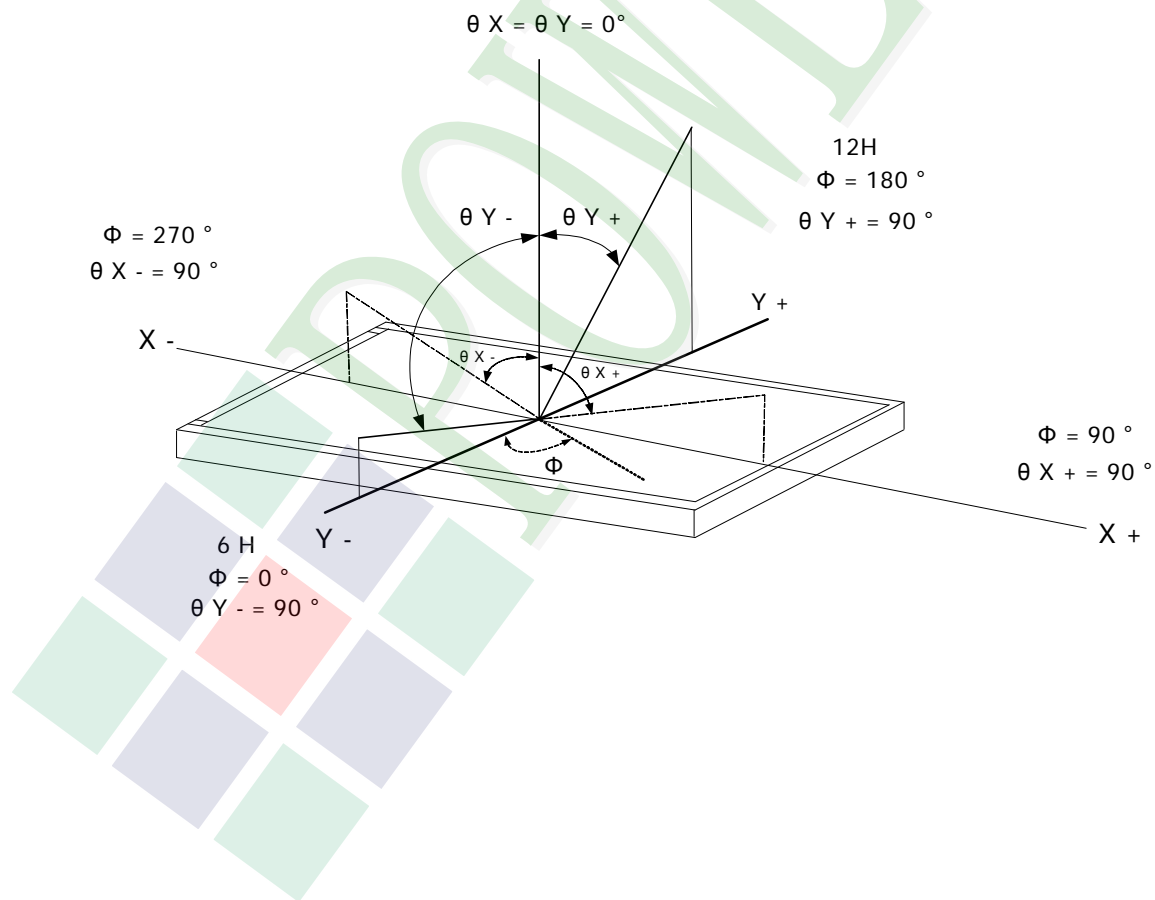

1.6 Backlight Characteristics

Maximum Ratings

Item	Symbol	Min.	Max.	Unit	Remark
LED Forward Current	I_F	30		mA	One LED
LED Reverse Voltage	V_R	5		V	

Electrical / Optical Characteristics

Item	Symbol	Min.	Typ.	Max.	Unit	Remark
LED Voltage	V_L	17.6	19.2	20.4	V	Note1
LED Current	I_L	-	40	-	mA	-
LED life time	-	50000	-	-	HR	Note2

Note 1: The LED Supply Voltage is defined by the number of LED at $T_a=25^\circ\text{C}$ and $I_L=40\text{ mA}$.

Note 2: The "LED life time" is defined as the module brightness decrease to 50% original brightness at $T_a=25^\circ\text{C}$ and $I_L=40\text{ mA}$. The LED life time could be decreased if operating I_L is larger than 40 mA.

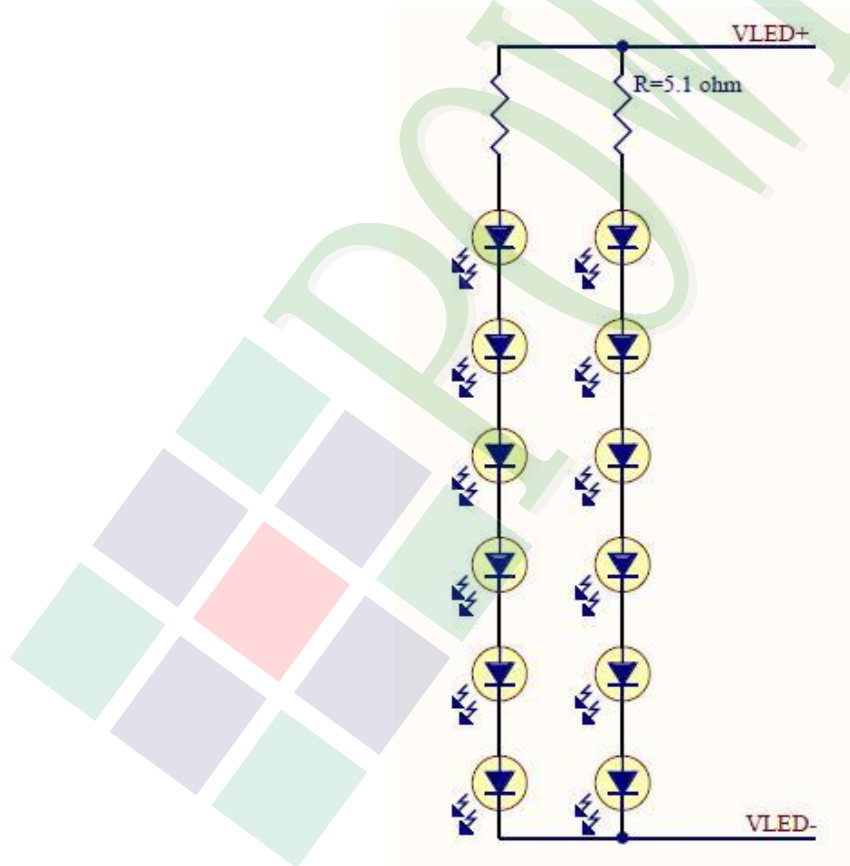

1.7 Touch Panel Characteristics

Features

Item	Standard Value
Touch Panel Size	4.3"
Touch type	Projective capacitive touch panel
Input Method	Finger Or Conductive Pen
Support Operation	5 Points touch
Output Interface	I ² C
IC	HY4635
I ² C Address	0x38

Mechanical Specifications

Item	Standard Value	Unit
Viewing Area	97.1 (W) * 55.9 (L)	mm

Absolute Maximum Ratings

Item	Symbol	Condition	Min.	Max.	Unit
Operating Temperature	T _{OP}	-	-20	+70	°C
Storage Temperature	T _{ST}	-	-30	+80	°C

DC Electrical Characteristics

Item	Symbol	Condition	Min.	Typ.	Max.	Unit
Power Supply Voltage	TPVDD	-	2.8	3.3	3.6	V

Optical Characteristics

Item	Standard Value	Unit
Total light transmittance	85% or more	-
Haze	3% or less	-

2. MODULE STRUCTURE

2.1 Counter Drawing

2.1.1 LCM Mechanical Diagram

* See Appendix

2.1.2 Block Diagram

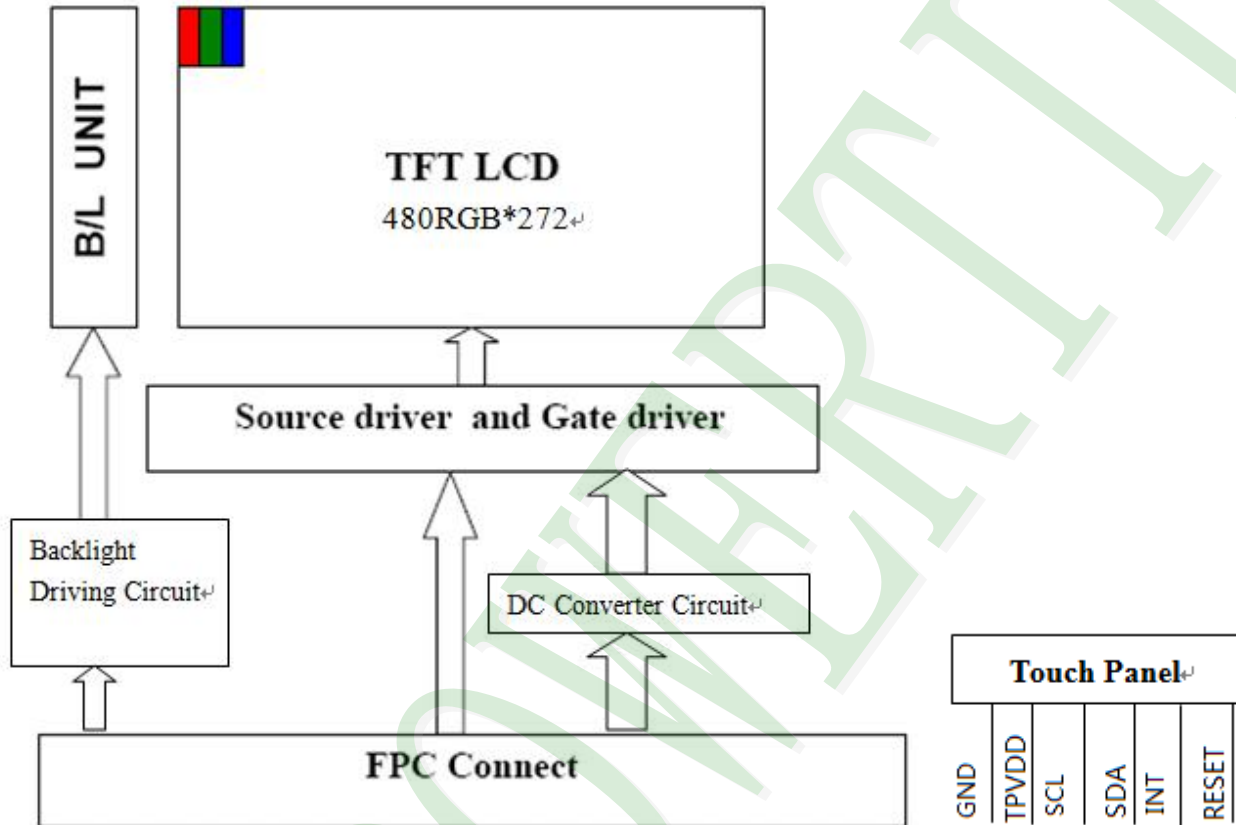

2.2 Interface Pin Description

TFT LCM Interface

Pin#	Name	DESCRIPTION
1	GND	Power ground.
2	VDD	Power for Digital Circuit.
3	VDD	Power for Digital Circuit.
4	VCC	Power For LED backlight.
5	VCC	Power For LED backlight.
6	PWM	Shutdown & Dimming control input for backlight. Do not allow this pin to float. "Hi" =100%, "Low" = 0%.
7	GND	Power ground.
8	R0	Red Data.
9	R1	Red Data.
10	R2	Red Data.
11	R3	Red Data.
12	GND	Power ground.
13	R4	Red Data.
14	R5	Red Data.
15	R6	Red Data.
16	R7	Red Data.
17	GND	Power ground.
18	G0	Green Data.
19	G1	Green Data.
20	G2	Green Data.
21	G3	Green Data.
22	GND	Power ground.
23	G4	Green Data.
24	G5	Green Data.
25	G6	Green Data.
26	G7	Green Data.
27	GND	Power ground.
28	B0	Blue Data.
29	B1	Blue Data.

Pin#	Name	DESCRIPTION
30	B2	Blue Data.
31	B3	Blue Data.
32	GND	Power ground.
33	B4	Blue Data.
34	B5	Blue Data.
35	B6	Blue Data.
36	B7	Blue Data.
37	GND	Power ground.
38	HS	Line synchronization signal. Horizontal Sync Input.
39	VS	Frame synchronization signal. Vertical Sync Input.
40	GND	Power ground.
41	DE	Display enable pin from controller. Data Input Enable.
42	GND	Power ground.
43	DCLK	Sample clock. Data will be latched at the falling edge of DCLK.
44	GND	Power ground.
45	CS(NC)	No Function.
46	SDIN(NC) / ID1	No Function./ ID[4:1]These pins select LCM type.
47	SCK(NC) / ID2	No Function / ID[4:1]These pins select LCM type.
48	DISPLAY CONTROL	Display Enable(Hi Active).
49	/RESET	Global Reset (Low Active).
50	GND	Power ground.

Capacitive Touch Panel (CTP) Interface

Pin No.	Symbol	Function
1	GND	Ground.
2	TPVDD	Power.
3	SCL	I ² C Clock.
4	SDA	I2C Data.
5	INT	The interrupt from the CTP to the Host.
6	RESET	RESET.

2.3 Timing Characteristics

2.3.1 Clock and Data Input Waveforms

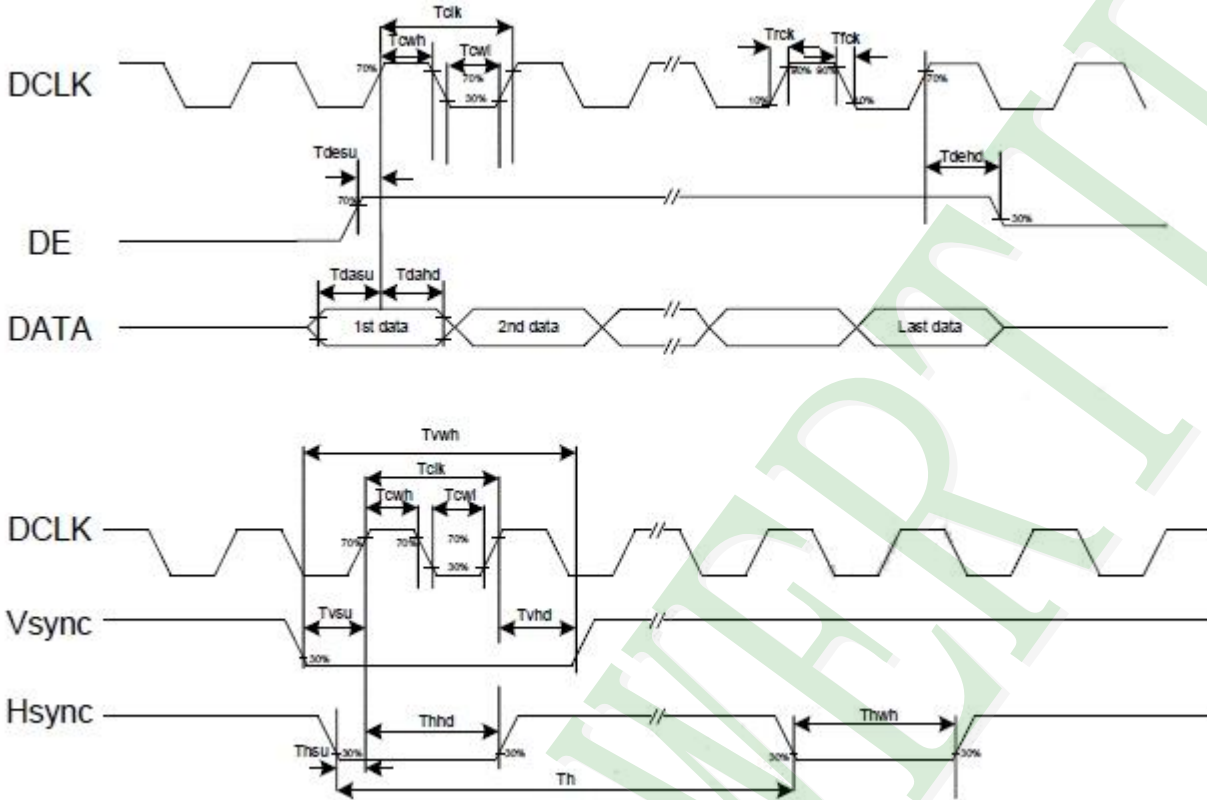

Parameters	Symbol	Min.	Typ.	Max.	Unit	Conditions
System operation timing						
VDD power source slew time	TPOR	-	-	20	ms	From 0V to 99% VDD
GRB pulse width	tRSTW	10	50	-	us	R=10Kohm, C=1uF
Input Output timing						
DCLK clock time	Tclk	33.3	-	-	ns	DCLK=30MHz
DCLK clock low period	Tcwl	40	-	60	%	
DCLK clock high period	Tcwh	40	-	60	%	
Clock rising time	Trck	9	-	-	ns	
Clock falling time	Tfck	9	-	-	ns	
HSD width	Thwh	1	-	-	DCLK	
HSD period time	Th	55	60	65	us	
HSD setup time	Thsu	12	-	-	ns	
HSD hold time	Thhd	12	-	-	ns	
VSD width	Tvwh	1	-	-	Th	
VSD setup time	Tvsu	12	-	-	ns	
VSD hold time	Tvhd	12	-	-	ns	
Data setup time	Tdasu	12	-	-	ns	
Data hold time	Tdahd	12	-	-	ns	
DE setup time	Tdesu	12	-	-	ns	
DE hold time	Tdehd	12	-	-	ns	
Source output setting time	Tsst	-	-	TBD	us	10% to 90% CL=60pF, RL=2Kohm
Gate output setting time	Tgst	-	-	TBD	ns	10% to 90%, CL=60pF
VCOM output setting time	Tcst	-	-	TBD	us	10% to 90%, CL=40nF, RL=50ohm
Time from VSD to 1st line data input	Tvs	3	8	31	Th	HV mode By HDL[4:0] setting

2.3.2 Data Input Format

Vertical input timing

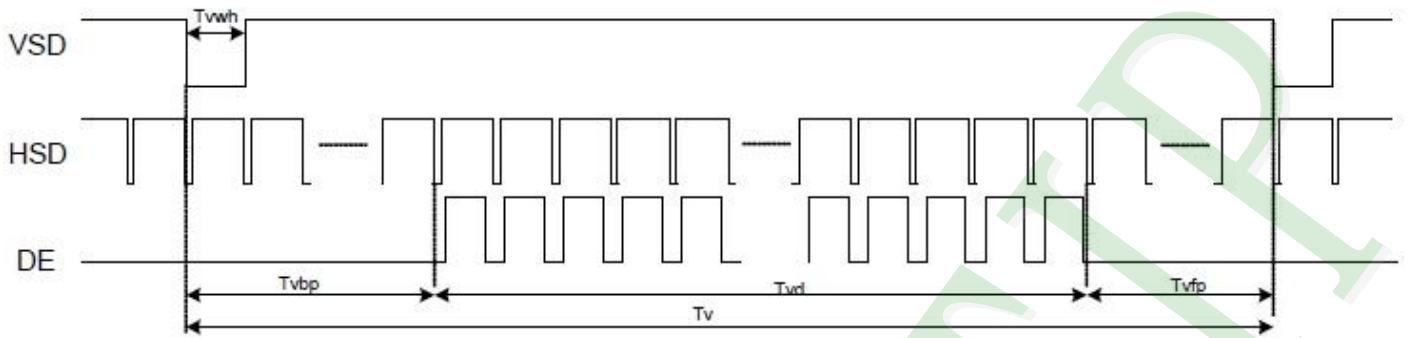

Parallel RGB Mode Data format

(HV Mode)

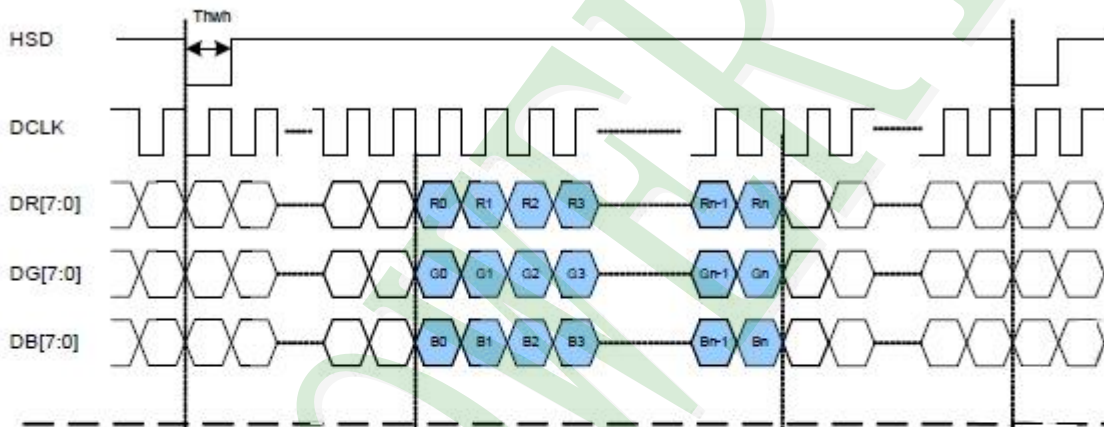

(DE Mode)

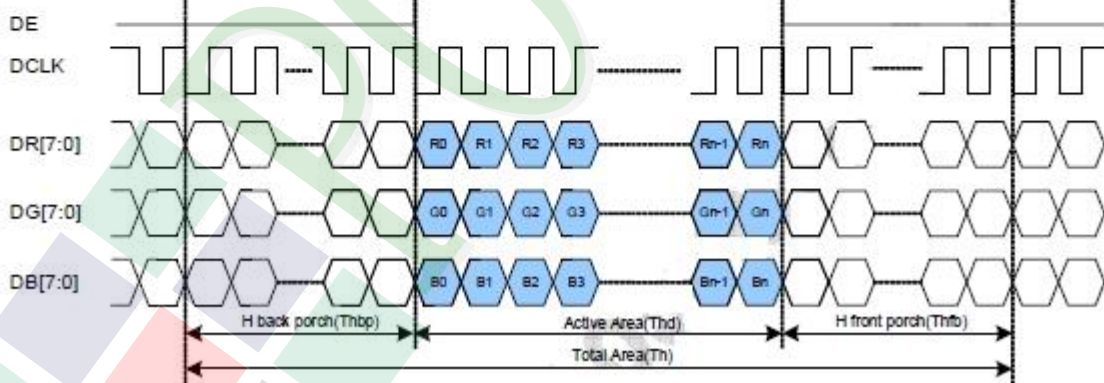

Parallel RGB input timing table

Parameters	Symbol	Value			Unit
		Min.	Typ.	Max.	
DCLK frequency	Fclk	5	9	12	MHz
VSYNC period time	Tv	277	288	400	H
VSYNC display area	Tvd	272			H
VSYNC back porch	Tvb	3	8	31	H
VSYNC front porch	Tvfp	2	8	97	H
HSYNC period time	Th	520	525	800	DCLK
HSYNC display area	Thd	480			DCLK
HSYNC back porch	Thbp	36	40	255	DCLK
HSYNC front porch	Thfp	4	5	65	DCLK

2.3.3 3-wire Timing Diagram

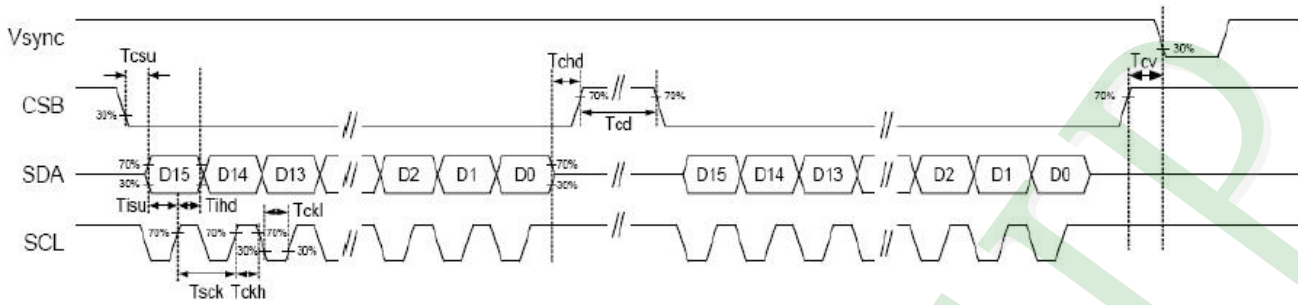

3-wire serial communication AC timing						
Serial clock	Tsck	200	-	-	ns	For SCL Pin
SCL pulse low period	Tckl	40	-	60	%	
SCL pulse high period	Tckh	40	-	60	%	
Serial data setup time	Tisu	50	-	-	ns	
Serial data hold time	Tihd	50	-	-	ns	
Serial clock high/low	Tssw	50	-	-	ns	
CSB to VSD	Tcv	1			us	
CSB distinguish time	Tcd	400	-	-	ns	
CSB input setup time	Tcsu	50	-	-	ns	
CSB input hold time	Tchd	50	-	-	ns	

2.3.4 Power Sequence

POWER ON

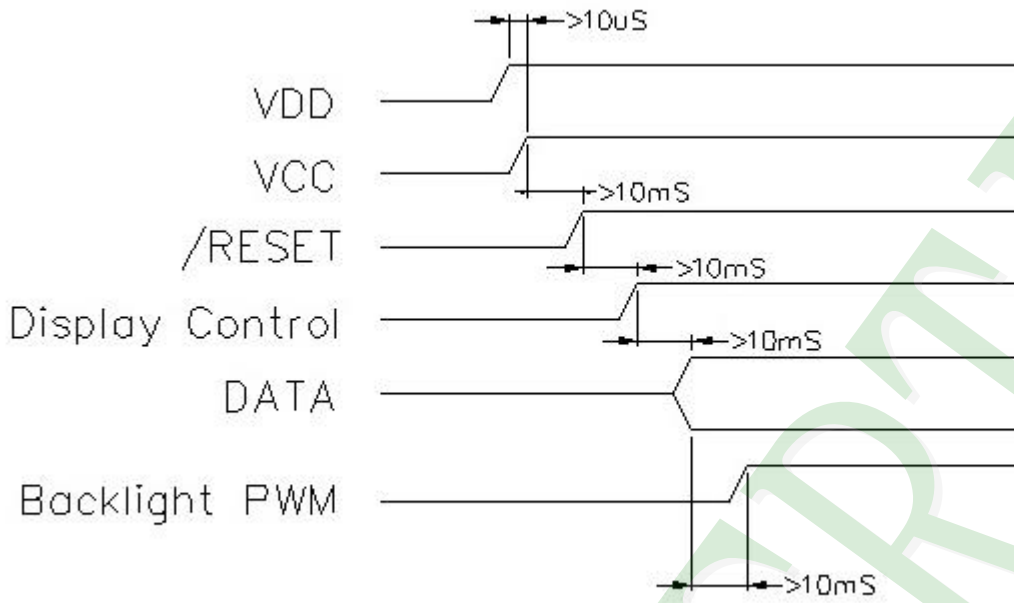

POWER OFF

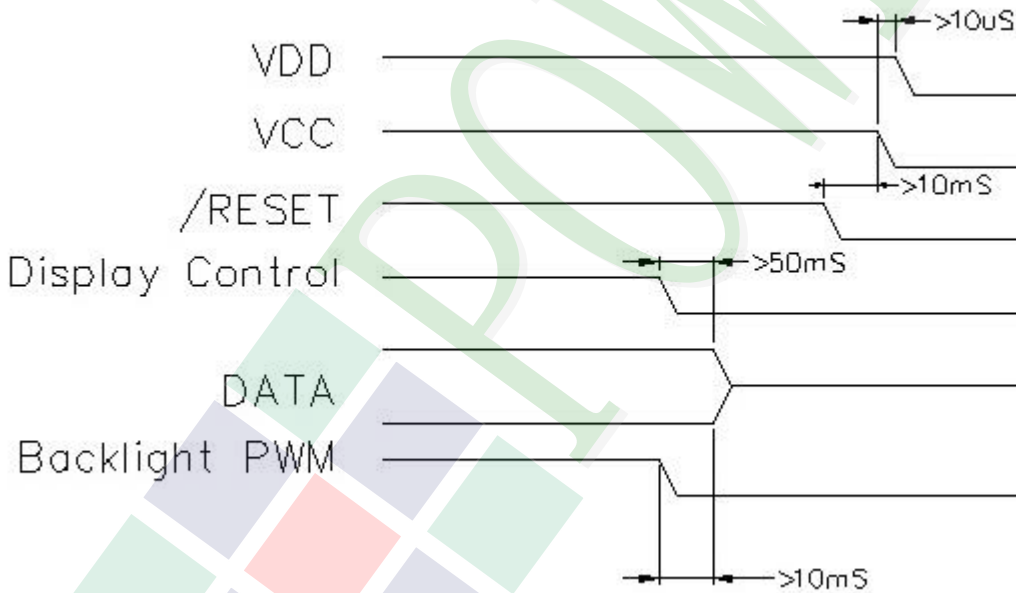

3. QUALITY ASSURANCE SYSTEM

3.1 Quality Assurance Flow Chart

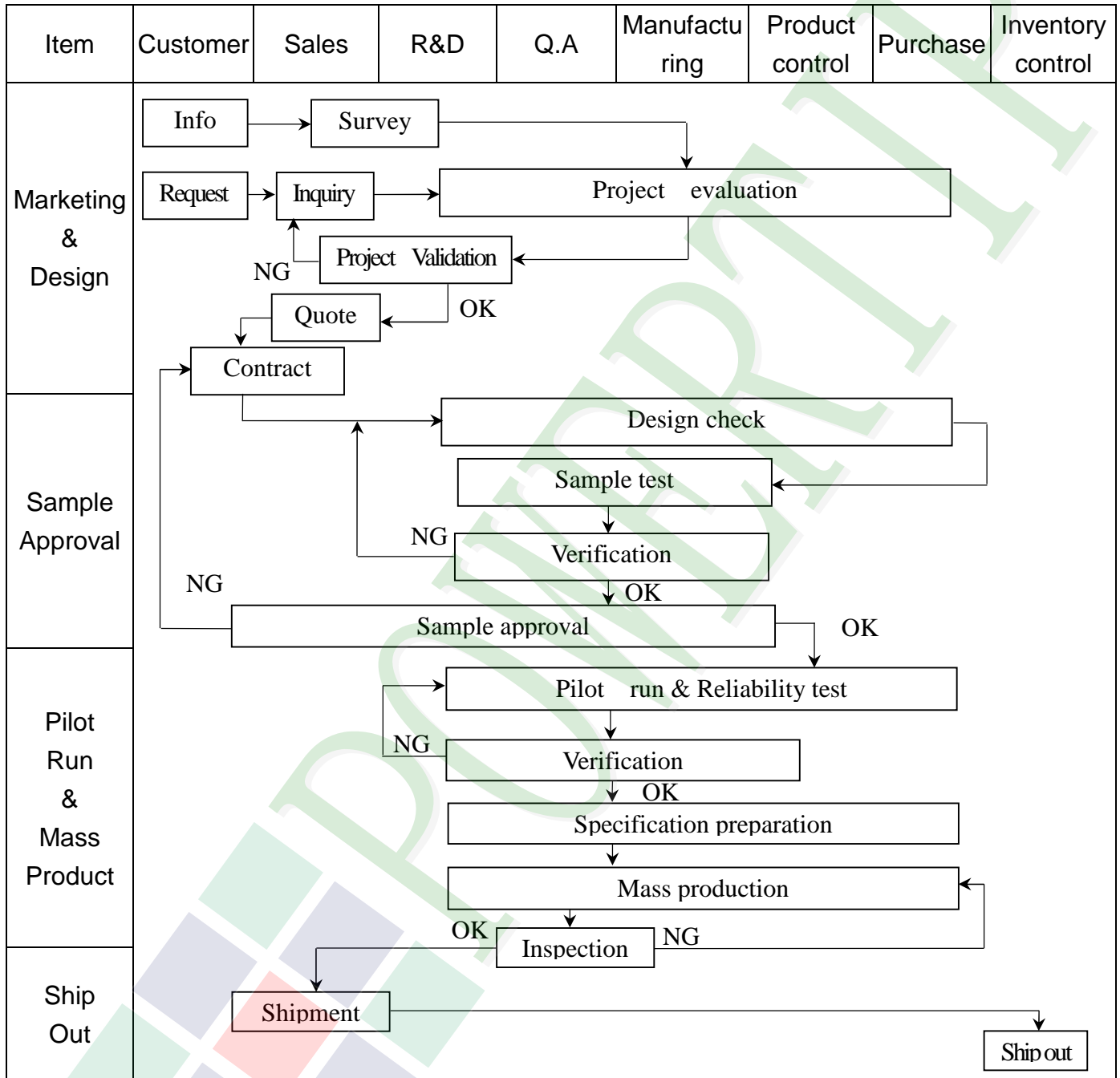

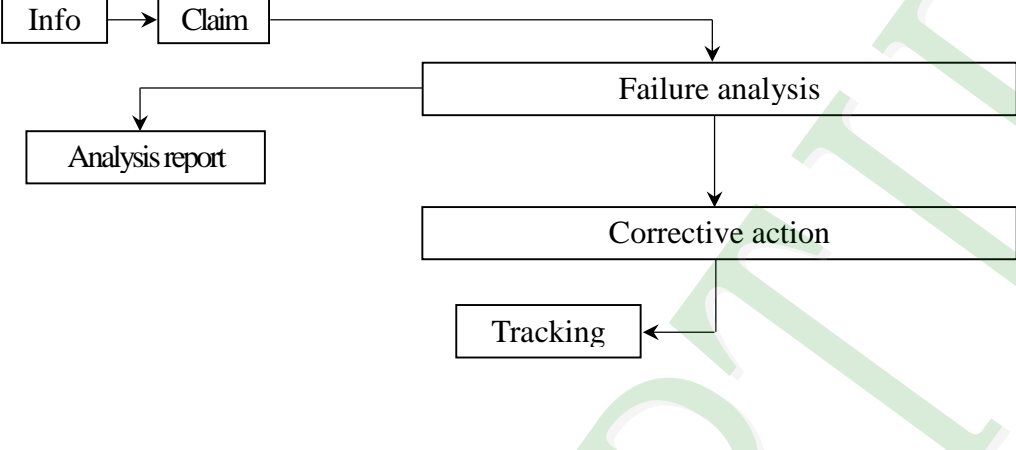
Item	Customer	Sales	R&D	Q.A	Manufacturing	Product control	Purchase	Inventory control
Sales Service	 <pre> graph TD Info[Info] --> Claim[Claim] Claim --> Failure[Failure analysis] Failure --> Report[Analysis report] Failure --> Action[Corrective action] Action --> Tracking[Tracking] </pre>							
Q.A Activity	1. ISO 9001 Maintenance Activities 3. Equipment calibration 5. Standardization Management				2. Process improvement proposal 4. Education And Training Activities			

3.2. Inspection Specification

◆Scope : The document shall be applied to TFT-LCD Module for 3.5" ~15" (Ver.B01).

◆Inspection Standard : MIL-STD-105E Table Normal Inspection Single Sampling Level II.

◆Equipment : Gauge 、MIL-STD 、Powertip Tester 、Sample

◆Defect Level : Major Defect AQL : 0.4 ; Minor Defect AQL : 1.5

◆OUT Going Defect Level : Sampling.

◆Standard of the product appearance test :

a. Manner of appearance test :

(1). The test best be under 20W×2 fluorescent light , and distance of view must be at 30 cm.

(2). The test direction is base on about around 45° of vertical line.

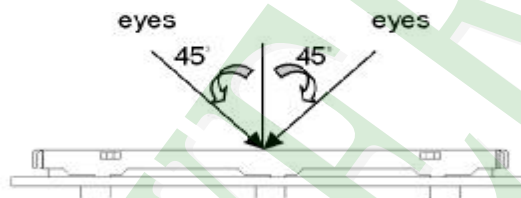

(3). Definition of area.

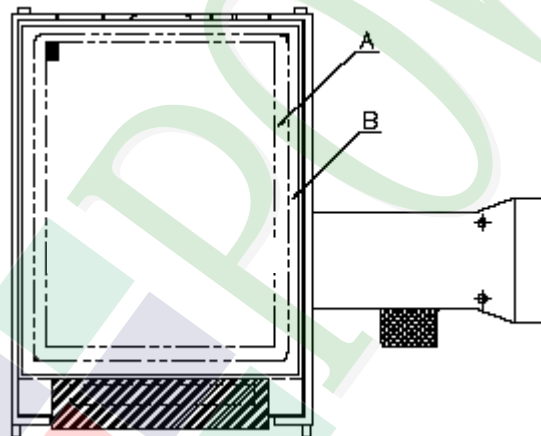

A area : viewing area

B area : Outside of viewing area

(4). Standard of inspection : (Unit : mm)

◆Specification For TFT-LCD Module 3.5" ~15" :
(Ver.B01)

NO	Item	Criterion	Level												
01	Product condition	1. 1 The part number is inconsistent with work order of production.	Major												
		1. 2 Mixed product types.	Major												
		1. 3 Assembled in inverse direction.	Major												
02	Quantity	2. 1 The quantity is inconsistent with work order of production.	Major												
03	Outline dimension	3. 1 Product dimension and structure must conform to structure diagram.	Major												
04	Electrical Testing	4. 1 Missing line character and icon.	Major												
		4. 2 No function or no display.	Major												
		4. 3 Display malfunction.	Major												
		4. 4 LCD viewing angle defect.	Major												
		4. 5 Current consumption exceeds product specifications.	Major												
		4. 6 Mura can not be seen through 5% ND filter. (Mura : Under the normal examination angle of view, the picture has the non-uniform phenomenon.)	Minor												
05	Dot defect (Bright dot 、 Dark dot) On -display	<table border="1"> <thead> <tr> <th colspan="2">Item</th> <th>Acceptance (Q'ty)</th> </tr> </thead> <tbody> <tr> <td rowspan="4">Dot Defect</td> <td>Bright Dot</td> <td>≤ 4</td> </tr> <tr> <td>Dark Dot</td> <td>≤ 5</td> </tr> <tr> <td>Joint Dot</td> <td>≤ 3</td> </tr> <tr> <td>Total</td> <td>≤ 7</td> </tr> </tbody> </table>	Item		Acceptance (Q'ty)	Dot Defect	Bright Dot	≤ 4	Dark Dot	≤ 5	Joint Dot	≤ 3	Total	≤ 7	Minor
		Item		Acceptance (Q'ty)											
		Dot Defect	Bright Dot	≤ 4											
			Dark Dot	≤ 5											
			Joint Dot	≤ 3											
Total	≤ 7														
5. 1 Inspection pattern : full white , full black , Red , Green and blue screens.															
5. 2 It is defined as dot defect if defect area $> 1/2$ dot.															
5. 3 The distance between two dot defect ≥ 5 mm.															
5. 4 Bright dot that can not be seen through 5% ND filter.															

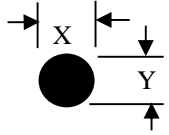
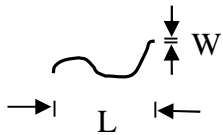
NO	Item	Criterion	Level																																																					
06	<p>Black or white dot、scratch、contamination</p> <p>Round type</p>  <p>$\Phi = (x + y) / 2$</p> <p>Line type</p> 	<p>6.1 Round type (Non-display or display) :</p> <table border="1"> <thead> <tr> <th rowspan="2">Dimension (diameter : Φ)</th> <th colspan="2">Acceptance (Q'ty)</th> </tr> <tr> <th>A area</th> <th>B area</th> </tr> </thead> <tbody> <tr> <td>$\Phi \leq 0.25$</td> <td colspan="2">Ignore</td> </tr> <tr> <td>$0.25 < \Phi \leq 0.50$</td> <td>5</td> <td rowspan="3">Ignore</td> </tr> <tr> <td>$\Phi > 0.50$</td> <td>0</td> </tr> <tr> <td>Total</td> <td>5</td> </tr> </tbody> </table> <p>6.2 Line type(Non-display or display) :</p> <table border="1"> <thead> <tr> <th rowspan="2">module size</th> <th rowspan="2">Length (L)</th> <th rowspan="2">Width (W)</th> <th colspan="2">Acceptance (Q'ty)</th> </tr> <tr> <th>A area</th> <th>B area</th> </tr> </thead> <tbody> <tr> <td rowspan="5">3.5" to less 9"</td> <td>---</td> <td>$W \leq 0.03$</td> <td>Ignore</td> <td rowspan="5">Ignore</td> </tr> <tr> <td>$L \leq 10.0$</td> <td>$0.03 < W \leq 0.05$</td> <td>4</td> </tr> <tr> <td>$L \leq 5.0$</td> <td>$0.05 < W \leq 0.10$</td> <td>2</td> </tr> <tr> <td>---</td> <td>$W > 0.10$</td> <td>As round type</td> </tr> <tr> <td colspan="2">Total</td> <td>5</td> </tr> <tr> <td rowspan="5">9" to 15"</td> <td>---</td> <td>$W \leq 0.05$</td> <td>Ignore</td> <td rowspan="5">Ignore</td> </tr> <tr> <td>$L \leq 10.0$</td> <td>$0.05 < W \leq 0.10$</td> <td>5</td> </tr> <tr> <td>---</td> <td>$W > 0.10$</td> <td>As round type</td> </tr> <tr> <td colspan="2">Total</td> <td>5</td> </tr> </tbody> </table>	Dimension (diameter : Φ)	Acceptance (Q'ty)		A area	B area	$\Phi \leq 0.25$	Ignore		$0.25 < \Phi \leq 0.50$	5	Ignore	$\Phi > 0.50$	0	Total	5	module size	Length (L)	Width (W)	Acceptance (Q'ty)		A area	B area	3.5" to less 9"	---	$W \leq 0.03$	Ignore	Ignore	$L \leq 10.0$	$0.03 < W \leq 0.05$	4	$L \leq 5.0$	$0.05 < W \leq 0.10$	2	---	$W > 0.10$	As round type	Total		5	9" to 15"	---	$W \leq 0.05$	Ignore	Ignore	$L \leq 10.0$	$0.05 < W \leq 0.10$	5	---	$W > 0.10$	As round type	Total		5	Minor
Dimension (diameter : Φ)	Acceptance (Q'ty)																																																							
	A area	B area																																																						
$\Phi \leq 0.25$	Ignore																																																							
$0.25 < \Phi \leq 0.50$	5	Ignore																																																						
$\Phi > 0.50$	0																																																							
Total	5																																																							
module size	Length (L)	Width (W)	Acceptance (Q'ty)																																																					
			A area	B area																																																				
3.5" to less 9"	---	$W \leq 0.03$	Ignore	Ignore																																																				
	$L \leq 10.0$	$0.03 < W \leq 0.05$	4																																																					
	$L \leq 5.0$	$0.05 < W \leq 0.10$	2																																																					
	---	$W > 0.10$	As round type																																																					
	Total		5																																																					
9" to 15"	---	$W \leq 0.05$	Ignore	Ignore																																																				
	$L \leq 10.0$	$0.05 < W \leq 0.10$	5																																																					
	---	$W > 0.10$	As round type																																																					
	Total		5																																																					
	07	<p>Polarizer Bubble</p>	<table border="1"> <thead> <tr> <th rowspan="2">Dimension (diameter : Φ)</th> <th colspan="2">Acceptance (Q'ty)</th> </tr> <tr> <th>A area</th> <th>B area</th> </tr> </thead> <tbody> <tr> <td>$\Phi \leq 0.25$</td> <td colspan="2">Ignore</td> </tr> <tr> <td>$0.25 < \Phi \leq 0.50$</td> <td>4</td> <td rowspan="4">Ignore</td> </tr> <tr> <td>$0.50 < \Phi \leq 0.80$</td> <td>1</td> </tr> <tr> <td>$\Phi > 0.80$</td> <td>0</td> </tr> <tr> <td>Total</td> <td>5</td> </tr> </tbody> </table>		Dimension (diameter : Φ)	Acceptance (Q'ty)		A area	B area	$\Phi \leq 0.25$	Ignore		$0.25 < \Phi \leq 0.50$	4	Ignore	$0.50 < \Phi \leq 0.80$	1	$\Phi > 0.80$	0	Total	5	Minor																																		
Dimension (diameter : Φ)	Acceptance (Q'ty)																																																							
	A area	B area																																																						
$\Phi \leq 0.25$	Ignore																																																							
$0.25 < \Phi \leq 0.50$	4	Ignore																																																						
$0.50 < \Phi \leq 0.80$	1																																																							
$\Phi > 0.80$	0																																																							
Total	5																																																							

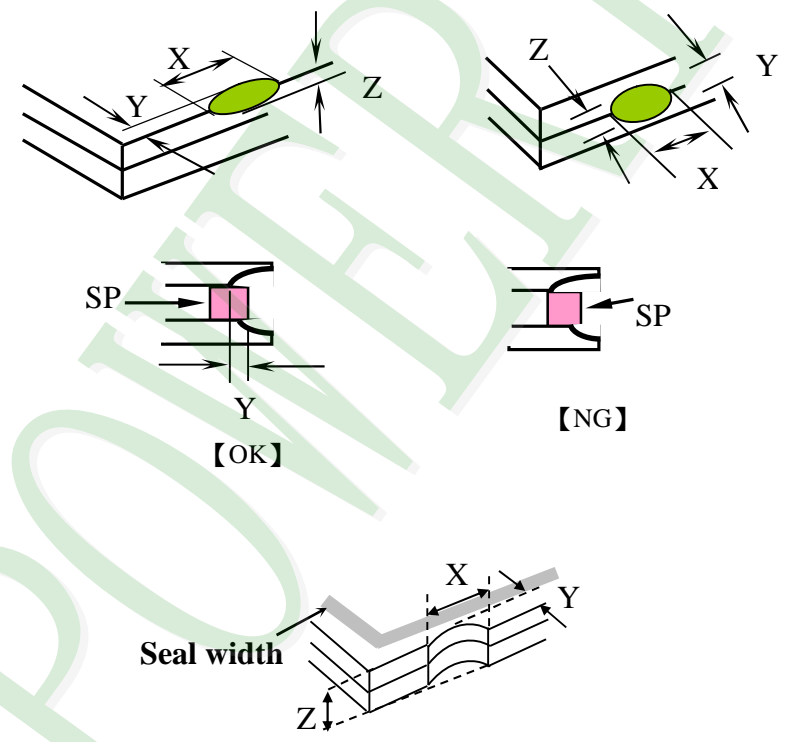
NO	Item	Criterion	Level						
08	The crack of glass	<p>Symbols :</p> <p>X : The length of crack Z : The thickness of crack t : The thickness of glass</p> <p>Y : The width of crack. W : terminal length a : LCD side length</p>	Minor						
		<p>8.1 General glass chip :</p> <p>8.1.1 Chip on panel surface and crack between panels:</p>  <table border="1" data-bbox="539 1579 1353 1870"> <thead> <tr> <th>X</th> <th>Y</th> <th>Z</th> </tr> </thead> <tbody> <tr> <td>$\leq a$</td> <td>Crack can't enter viewing area</td> <td>$\leq 1/2 t$</td> </tr> <tr> <td>$\leq a$</td> <td>Crack can't exceed the half of SP width.</td> <td>$1/2 t < Z \leq 2 t$</td> </tr> </tbody> </table>		X	Y	Z	$\leq a$	Crack can't enter viewing area	$\leq 1/2 t$
X	Y	Z							
$\leq a$	Crack can't enter viewing area	$\leq 1/2 t$							
$\leq a$	Crack can't exceed the half of SP width.	$1/2 t < Z \leq 2 t$							

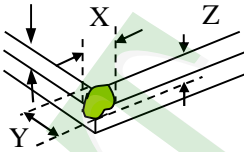
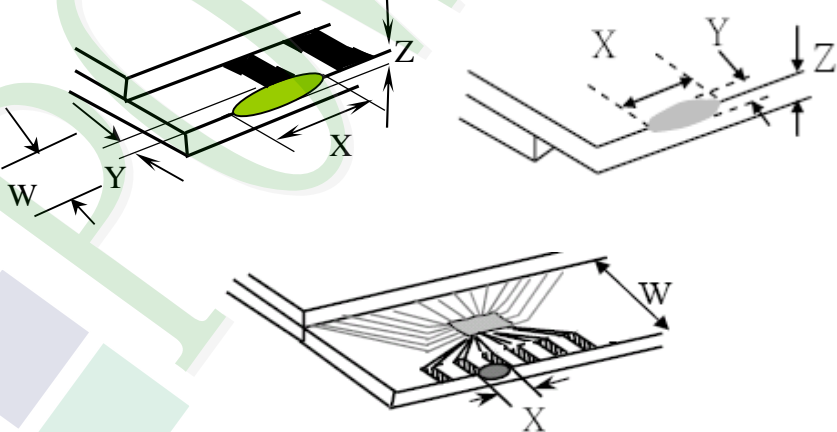
NO	Item	Criterion	Level												
08	The crack of glass	<p>Symbols :</p> <p>X : The length of crack Z : The thickness of crack t : The thickness of glass</p> <p>Y : The width of crack. W : terminal length a : LCD side length</p> <hr/> <p>8.1.2 Corner crack :</p>  <table border="1" data-bbox="520 768 1337 1059"> <thead> <tr> <th>X</th> <th>Y</th> <th>Z</th> </tr> </thead> <tbody> <tr> <td>$\leq 1/5 a$</td> <td>Crack can't enter viewing area</td> <td>$Z \leq 1/2 t$</td> </tr> <tr> <td>$\leq 1/5 a$</td> <td>Crack can't exceed the half of SP width.</td> <td>$1/2 t < Z \leq 2 t$</td> </tr> </tbody> </table>	X	Y	Z	$\leq 1/5 a$	Crack can't enter viewing area	$Z \leq 1/2 t$	$\leq 1/5 a$	Crack can't exceed the half of SP width.	$1/2 t < Z \leq 2 t$				
		X	Y	Z											
$\leq 1/5 a$	Crack can't enter viewing area	$Z \leq 1/2 t$													
$\leq 1/5 a$	Crack can't exceed the half of SP width.	$1/2 t < Z \leq 2 t$													
		<p>8.2 Protrusion over terminal :</p> <p>8.2.1 Chip on electrode pad :</p>  <table border="1" data-bbox="560 1697 1347 1872"> <thead> <tr> <th></th> <th>X</th> <th>Y</th> <th>Z</th> </tr> </thead> <tbody> <tr> <td>Front</td> <td>$\leq a$</td> <td>$\leq 1/2 W$</td> <td>$\leq t$</td> </tr> <tr> <td>Back</td> <td>$\leq a$</td> <td>$\leq W$</td> <td>$\leq 1/2 t$</td> </tr> </tbody> </table>		X	Y	Z	Front	$\leq a$	$\leq 1/2 W$	$\leq t$	Back	$\leq a$	$\leq W$	$\leq 1/2 t$	Minor
	X	Y	Z												
Front	$\leq a$	$\leq 1/2 W$	$\leq t$												
Back	$\leq a$	$\leq W$	$\leq 1/2 t$												

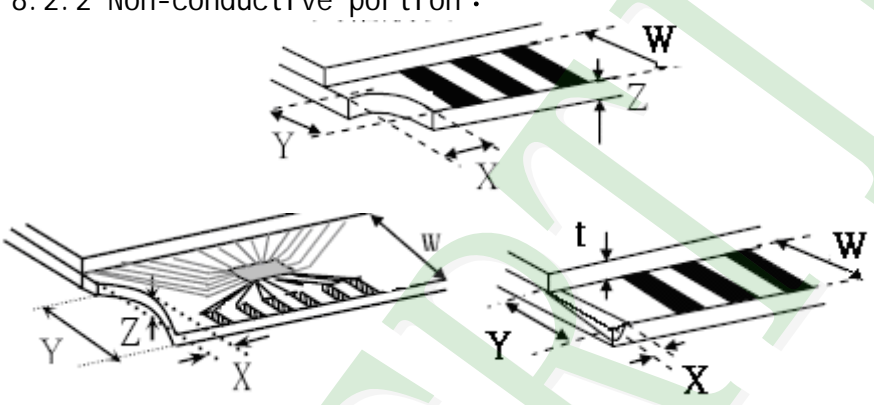
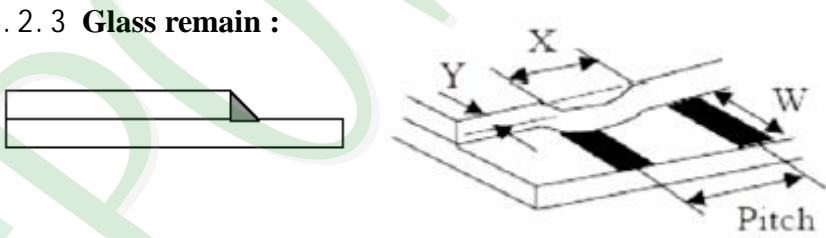
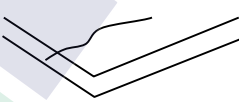
NO	Item	Criterion	Level												
08	The crack of glass	<p>Symbols :</p> <p>X : The length of crack Y : The width of crack. Z : The thickness of crack W : terminal length t : The thickness of glass a : LCD side length</p> <hr/> <p>8.2.2 Non-conductive portion :</p>  <table border="1" data-bbox="625 967 1257 1093"> <thead> <tr> <th>X</th> <th>Y</th> <th>Z</th> </tr> </thead> <tbody> <tr> <td>$\leq 1/3 a$</td> <td>$\leq W$</td> <td>$\leq t$</td> </tr> </tbody> </table> <p>⊙ If the chipped area touches the ITO terminal, over 2/3 of the ITO must remain and be inspected according to electrode terminal specifications.</p> <p>8.2.3 Glass remain :</p>  <table border="1" data-bbox="545 1523 1241 1648"> <thead> <tr> <th>X</th> <th>Y</th> <th>Z</th> </tr> </thead> <tbody> <tr> <td>$\leq a$</td> <td>$\leq 1/3 W$</td> <td>$\leq t$</td> </tr> </tbody> </table> <p>8.2.4 Cracking</p>  <p style="text-align: center;">Not Allowed</p>	X	Y	Z	$\leq 1/3 a$	$\leq W$	$\leq t$	X	Y	Z	$\leq a$	$\leq 1/3 W$	$\leq t$	Minor
X	Y	Z													
$\leq 1/3 a$	$\leq W$	$\leq t$													
X	Y	Z													
$\leq a$	$\leq 1/3 W$	$\leq t$													

◆Specification For TFT-LCD Module 3.5" ~15" :
(Ver.B01)

NO	Item	Criterion	Level
09	Backlight elements	9. 1 Backlight can't work normally.	Major
		9. 2 Backlight doesn't light or color is wrong.	Major
		9. 3 Illumination source flickers when lit.	Major
10	General appearance	10. 1 Pin type 、 quantity 、 dimension must match type in structure diagram.	Major
		10. 2 No short circuits in components on PCB or FPC .	Major
		10. 3 Parts on PCB or FPC must be the same as on the production characteristic chart .There should be no wrong parts , missing parts or excess parts.	Major
		10. 4 Product packaging must the same as specified on packaging specification sheet.	Minor
		10. 5 The folding and peeled off in polarizer are not acceptable.	Minor
		10. 6 The PCB or FPC between B/L assembled distance(PCB or FPC) is ≤ 1.5 mm.	Minor

5. PRECAUTION RELATING PRODUCT HANDLING

5.1 SAFETY

- 5.1.1 If the LCD panel breaks , be careful not to get the liquid crystal to touch your skin.
- 5.1.2 If the liquid crystal touches your skin or clothes , please wash it off immediately by using soap and water.

5.2 HANDLING

- 5.2.1 Avoid any strong mechanical shock which can break the glass.
- 5.2.2 Avoid static electricity which can damage the CMOS LSI—When working with the module , be sure to ground your body and any electrical equipment you may be using.
- 5.2.3 Do not remove the panel or frame from the module.
- 5.2.4 The polarizing plate of the display is very fragile. So , please handle it very carefully ,do not touch , push or rub the exposed polarizing with anything harder than an HB pencil lead (glass , tweezers , etc.)
- 5.2.5 Do not wipe the polarizing plate with a dry cloth , as it may easily scratch the surface of plate.
- 5.2.6 Do not touch the display area with bare hands , this will stain the display area.
- 5.2.7 Do not use ketonics solvent & aromatic solvent. Use with a soft cloth soaked with a cleaning naphtha solvent.
- 5.2.8 To control temperature and time of soldering is $320\pm 10^{\circ}\text{C}$ and 3-5 sec.
- 5.2.9 To avoid liquid (include organic solvent) stained on LCM .

5.3 STORAGE

- 5.3.1 Store the panel or module in a dark place where the temperature is $25^{\circ}\text{C} \pm 5^{\circ}\text{C}$ and the humidity is below 65% RH.
- 5.3.2 Do not place the module near organics solvents or corrosive gases.
- 5.3.3 Do not crush , shake , or jolt the module.

5.4 TERMS OF WARRANTY

- 5.4.1 Applicable warrant period
The period is within thirteen months since the date of shipping out under normal using and storage conditions.
- 5.4.2 Unaccepted responsibility
This product has been manufactured to your company's specification as a part for use in your company's general electronic products. It is guaranteed to perform according to delivery specifications. For any other use apart from general electronic equipment , we cannot take responsibility if the product is used in nuclear power control equipment , aerospace equipment , fire and security systems or any other applications in which there is a direct risk to human life and where extremely high levels of reliability are required.

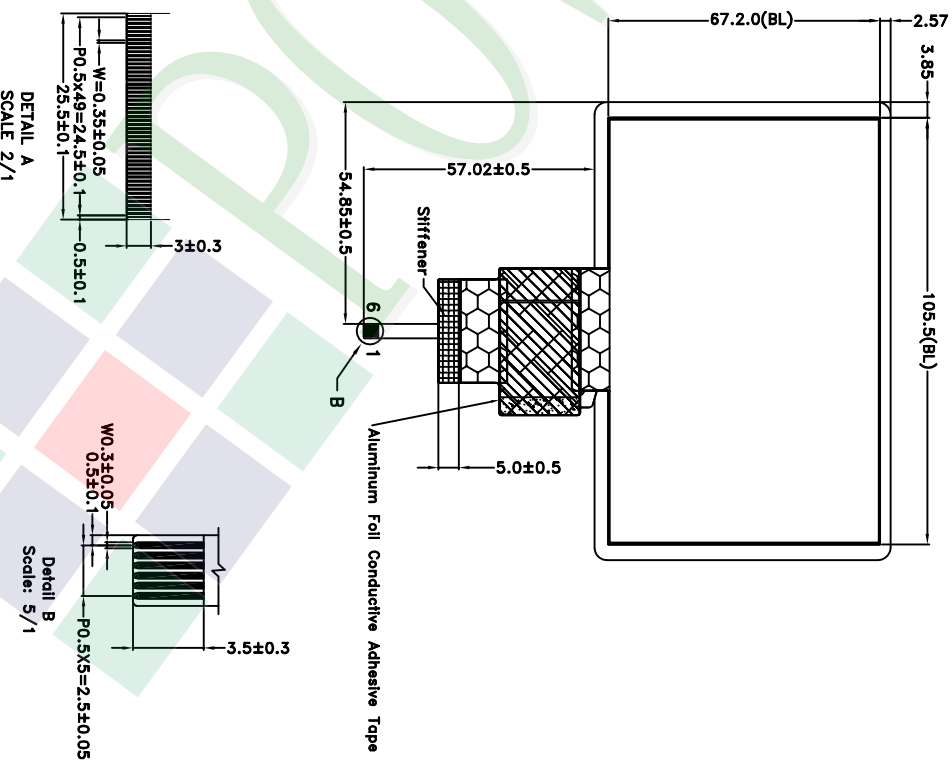
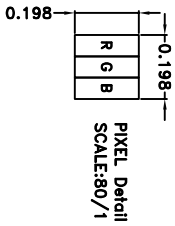
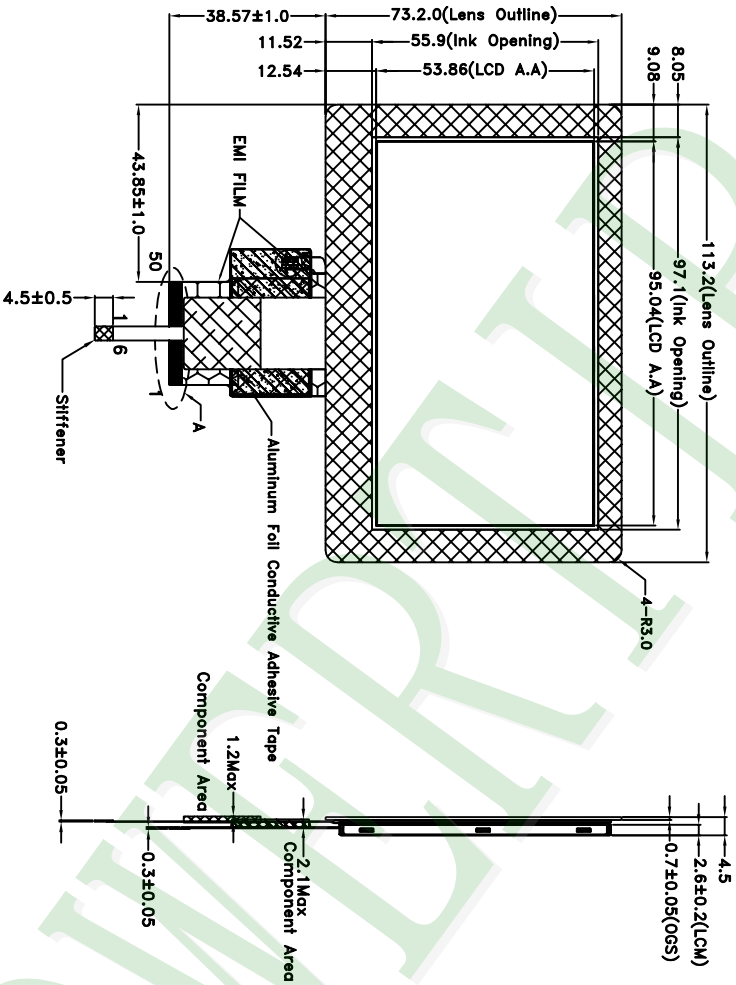

NOTES:
1.LCD TYPE: a-Si TFT
2.LCD DISPLAY: POSITIVE/TRANSMISSIVE
3.VIEW DIRECTION: 6 O'CLOCK
4.The tolerance unless classified ±0.3mm
5.FPC suggested connector : Cvilux CF31501D0R2-05-NH or compatible.
6.FPC Matching Connector: Livlux CF23041D0RN-LF or compatible.

007																					
006																					
005																					
004																					
003																					
002																					
001	NEW DRAWING																				
REV		REV BY	Sally	REVISER	DATE	2017/02/27															
PART NO:		PH4802721009-IHC05		DRAWING NAME:		JLMD-PH4802721009-IHC05		TITLE:		LCD MODULE DRAWING		Design		Sally		Unit		Surface		Precision Level	
		Check		Terry		Scale		1:1		Thickness		1 ~ 4		4 ~ 16		16 ~ 63		63 ~ 250		250 ~ 1000	
		Approve		Ryan		Page		1/1		Quantity											

久正光電股份有限公司
POWER TIP TECHNOLOGY CORPORATION

Ver.001

LCM包裝規格書

Documents NO. JPKG-PH480272T009-IHC05

LCM Packaging Specifications
(For Tray)

Approve	Check	Contact
Ryan	Terry	Sally

1. 包裝材料規格表 (Packaging Material) : (per carton)

No.	Item	Model	Dimensions (mm)	1Pcs Weight	Quantity	Total Weight
1	成品 (LCM)	PH480272T009-IHC05	113.2 X 73.2 X 4.5	0.0682	168	11.4576
2	多層薄膜(1)POF	OTFILM0BA03ABA	19"X350X0.015	—	6	—
3	TRAY 盤 (2)Tray	TYSG000000089	352 X 260 X 12.3	0.08	48	3.84
4	內盒(3)Product Box	BX36627063ABBA	383 X 270 X 66	0.182	6	1.092
5	保利龍板(4)Pollyon board	OTPLB00PL08ABA	550 X 393 X 20	0.0284	2	0.0568
6	外紙箱(5)Carton	BX57041027CCBA	570 X 410 X 265	1.0	1	1.0
7						
8						
9						

2. 一整箱總重量 (Total LCD Weight in carton) : 17.45 Kg±10%

3. 單箱數量規格表 (Packaging Specifications and Quantity) :

(1) LCM quantity per box : no per tray	4	x no of tray	7	=	28
(2) Total LCM quantity in carton : quantity per box	28	x no of boxes	6	=	168

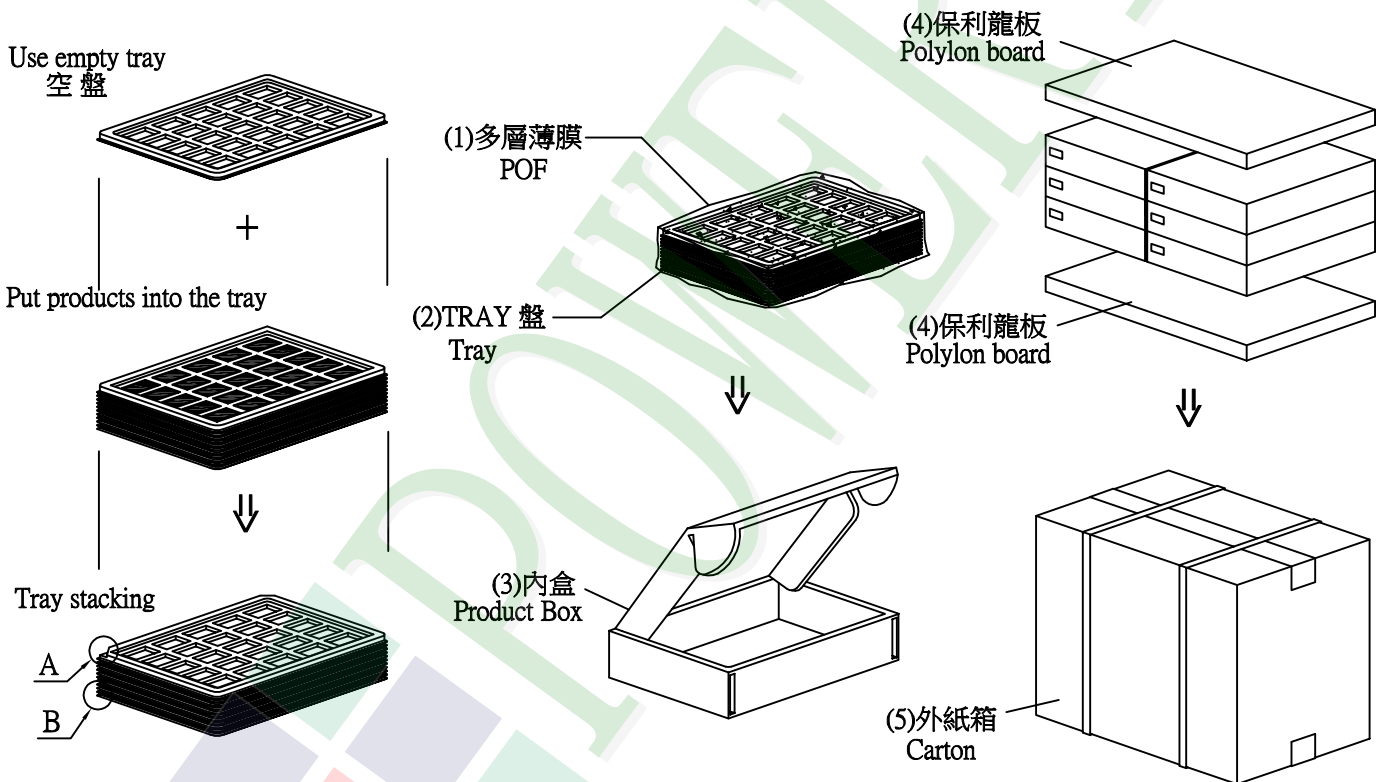

特 記 事 項 (REMARK)

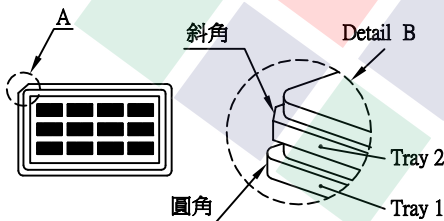

4. TRAY 盤相疊時, 需旋轉180度, 請詳見B視圖
Rotate tray 180 degrees and place on top of stack.
Check the tray stack using Fig. B.