



American Opto Plus LED Corp.

L199LWD-35K-TR

1.0 x 0.5 x 0.5mm 3500K White SMD LED

PACKAGE OUTLINES

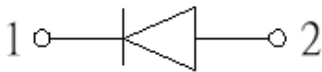
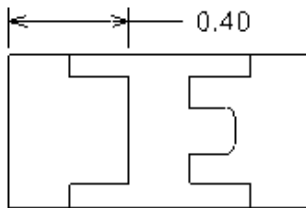
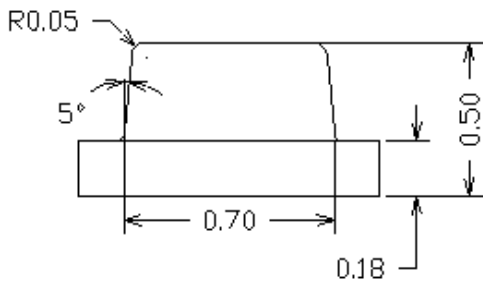
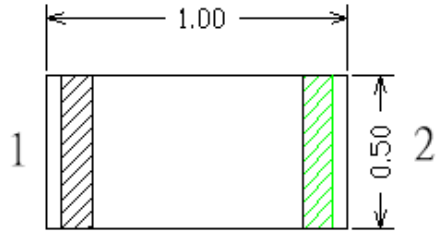

RECOMMEND PAD LAYOUT

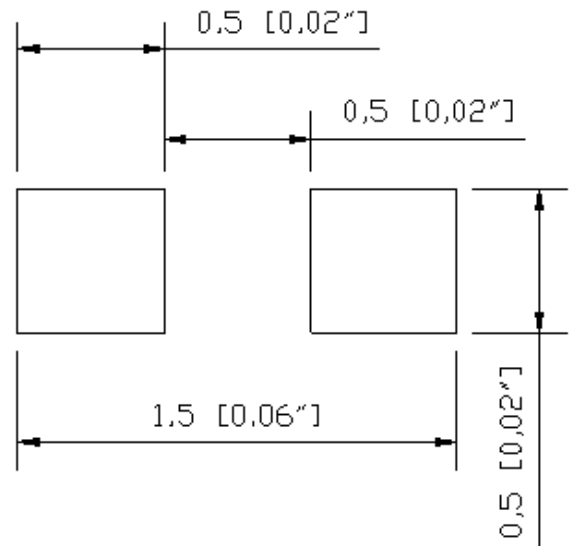

ITEM	MATERIALS
Resin (mold)	Epoxy
Lens Color	Yellow
Dice	InGaN
Emitted Color	White

Notes:

1. All dimensions are in millimeters (inches)
2. Tolerances are $\pm 0.1\text{mm}$ (0.004inch) unless otherwise noted

Version 1.0 Date: 11-27-2018 Specifications are subject to change without notice.

American Opto Plus LED Corp. 1206 E. Lexington Ave., Pomona CA 91766 Tel: 909-465-0080 Fax: 909-465-0130 www.aopled.com



American Opto Plus LED Corp.

L199LWD-35K-TR

1.0 x 0.5 x 0.5mm 3500K White SMD LED

ABSOLUTE MAXIMUM RATINGS

(Ta=25°C)

	Symbol	Value	Unit
Forward Current	If	30	mA
Reverse Voltage	Vr	5	V
Power Dissipation	Pd	111	mW
Operating Temperature	Top	-40~+80	°C
Storage Temperature	Tstg	-40~+85	°C
Peak Pulsing Current (1/8 duty f=1kHz)	Ifp	125	mA

ELECTRO-OPTICAL CHARACTERISTICS

(Ta=25°C)

	Test Condition	Symbol	Value			Unit
			Min	Typ	Max	
CIE Coordinates	If=20mA	X	--	0.402	--	--
		Y	--	0.393	--	
Forward Voltage		Vf	2.8	3.1	3.7	V
Luminous Intensity		Iv	160	310	500	mcd
Viewing Angle at 50% Iv	If=10mA	2θ1/2	--	150	--	Deg
Reverse Current	Vr=5V	Ir	--	--	10	µA



American Opto Plus LED Corp.

L199LWD-35K-TR

1.0 x 0.5 x 0.5mm 3500K White SMD LED

OPTICAL CHARACTERISTIC CURVES

Relative Intensity vs. Wavelength

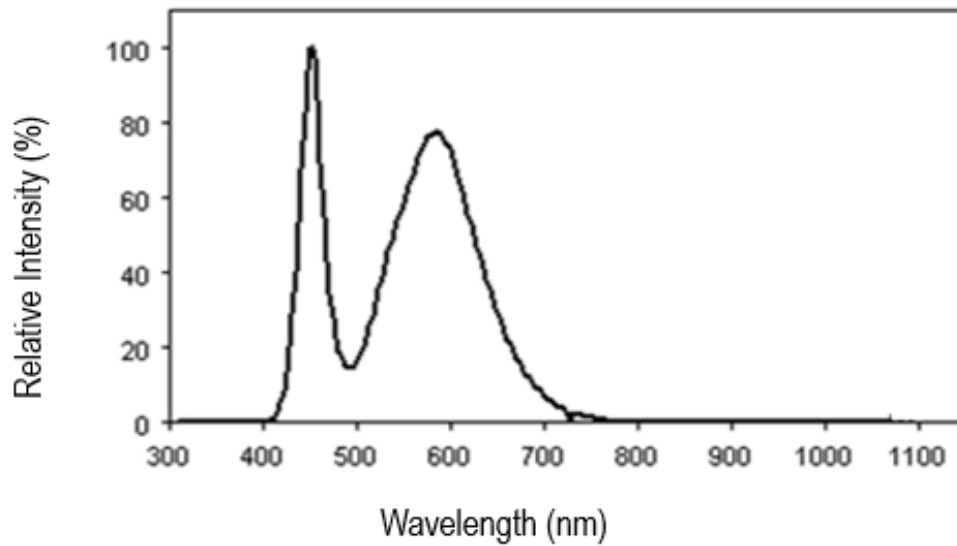

Forward Current vs. Forward Voltage

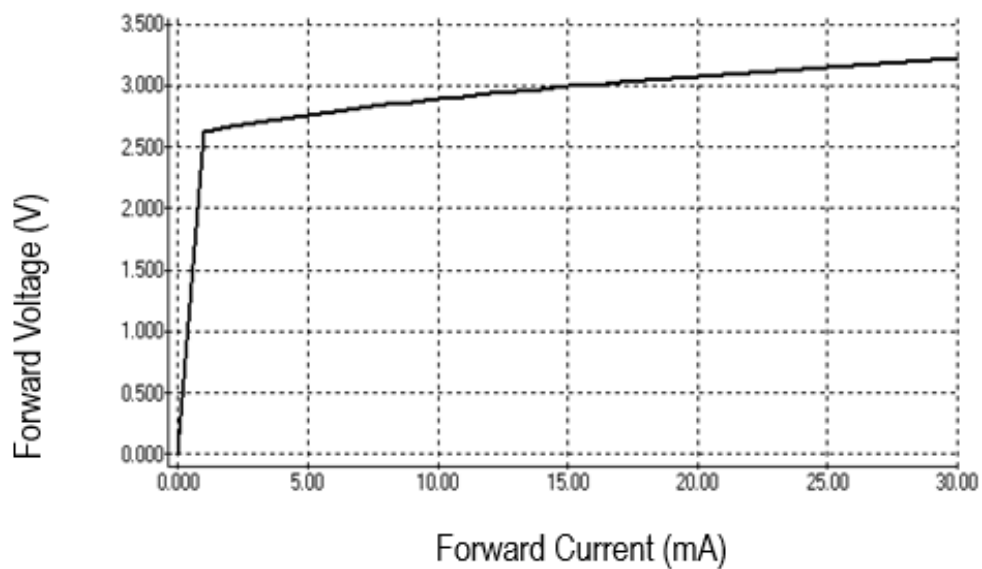



American Opto Plus LED Corp.

L199LWD-35K-TR

1.0 x 0.5 x 0.5mm 3500K White SMD LED

REFLOW PROFILE

- Reflow Temp/time

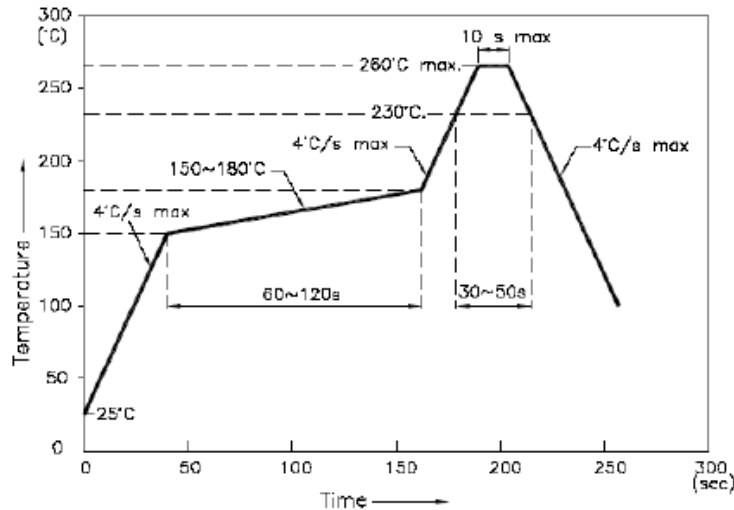

Notes:

1. We recommend the reflow temperature 245°C ($\pm 5^\circ\text{C}$). The maximum soldering temperature should be limited to 260°C
2. Do not cause stress to the epoxy resin while it is exposed to high temperature
3. Number of reflow process shall be 2 times or less

- Soldering Iron

Basic spec is $\leq 5\text{sec}$ when 260°C. If temperature is higher, time should be shorter ($+10^\circ\text{C} \rightarrow -1\text{sec}$). Power dissipation of iron should be smaller than 20W, and temperatures should be controllable. Surface temperature of the device should be under 230°C

- Rework

1. Customer must finish rework within 5 sec under 260°C
2. The head of iron cannot touch copper foil
3. Twin-head type is preferred

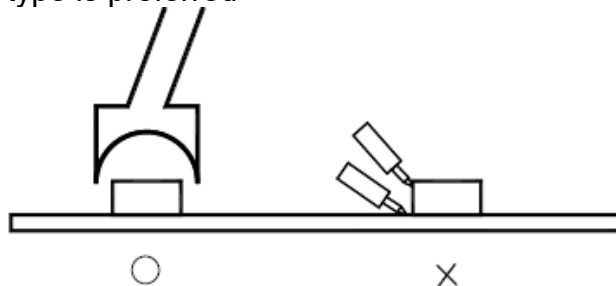

- Avoid rubbing or scraping the resin by any object, during high temperature, for example reflow, solder etc



American Opto Plus LED Corp.

L199LWD-35K-TR

1.0 x 0.5 x 0.5mm 3500K White SMD LED

TEST CIRCUIT

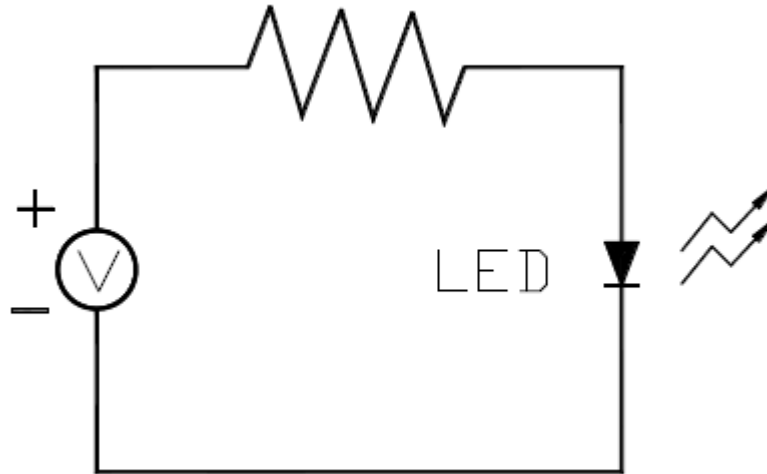

HANDLING PRECAUTIONS

1. Over-Current-Proof
Customer must apply resistors for protection; otherwise slight voltage shift will cause big current change (Burn out will happen)
2. Shelf life in sealed bag: 12 month at 5°C~30°C and <60% R.H;
3. After the package is opened:
 - 3.1. It is recommended to baking before the first use:
Baking condition:
 - a. 60±5°C x (24~48hrs) and <5%RH, taped reel type
 - b. 110±5°C x (8-16hr), bulk type
 - 3.2. The products should be used within a week or they should be keeping to be stored at ≤20 R.H. with zip-lock sealed
 - a. It is recommended to baking before soldering when the pack is unsealed after 24hrs
 - b. Baking condition as 3.1 baking condition



American Opto Plus LED Corp.

L199LWD-35K-TR

1.0 x 0.5 x 0.5mm 3500K White SMD LED

RELIABILITY TEST

Type	Test Item	Test Conditions	Note	Number of Damaged
Environmental Sequence	Temperature Cycle	-20°C 30min ↑↓ 80°C 30min	100 cycle	0/22
	Thermal Shock	-20°C 15min ↑↓ 80°C 15min	100 cycle	0/22
	High Humidity Heat Cycle	30°C ↔ 65°C 90%RH 24hrs/1cycle	10 cycle	0/22
	High Temperature Storage	T _a =80°C	1000 hrs	0/22
	Humidity Heat Storage	T _a =60°C RH=90%	1000 hrs	0/22
	Low Temperature Storage	T _a =-30°C	1000 hrs	0/22
Operation Sequence	Life Test	T _a =25°C I _F =20mA	1000 hrs	0/22
	High Humidity Heat Life Test	60°C RH=90% I _F =10mA	500 hrs	0/22
	Low Temperature Life Test	T _a =-20°C I _F =20mA	1000 hrs	0/22



American Opto Plus LED Corp.

L199LWD-35K-TR

1.0 x 0.5 x 0.5mm 3500K White SMD LED

PACKAGING SPECIFICATIONS

- Feeding Direction

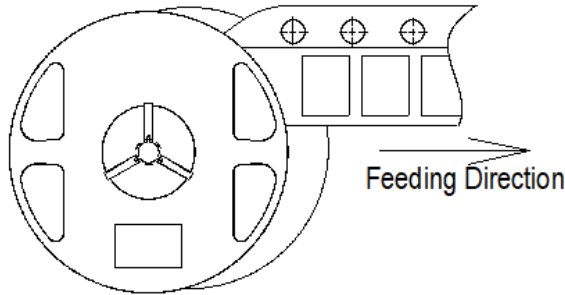

- Dimensions of Reel (Unit: mm)

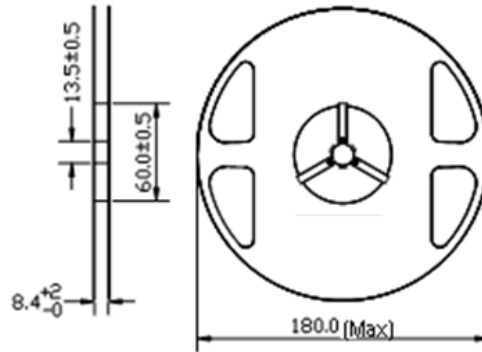

- Dimensions of Tape (Unit: mm)

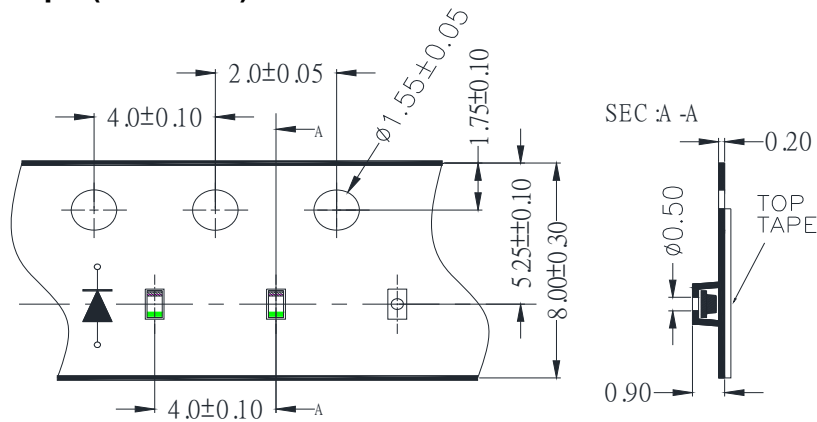

- Arrangement of Tape

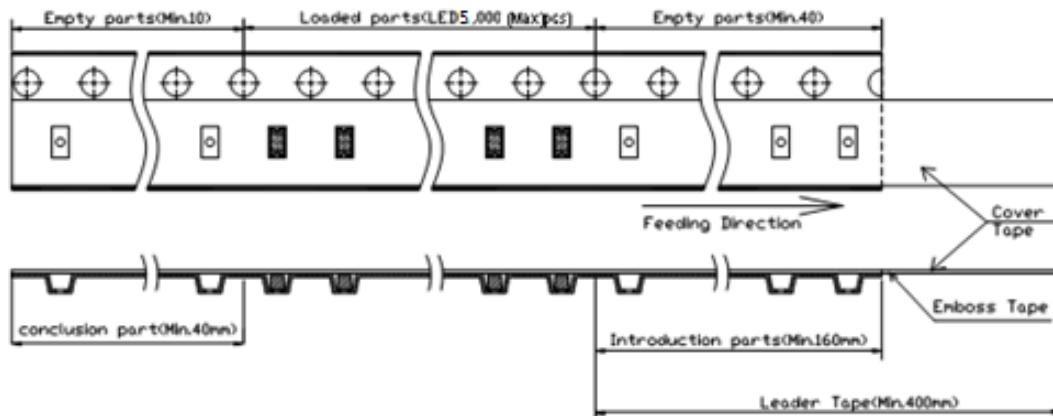

Notes:

1. Empty component pockets are sealed with top cover tape
2. The maximum number of missing lamps is two
3. The cathode is oriented towards the tape sprocket hole
4. 5,000(Max) pcs/Reel



American Opto Plus LED Corp.

L199LWD-35K-TR

1.0 x 0.5 x 0.5mm 3500K White SMD LED

PACKAGING SPECIFICATIONS

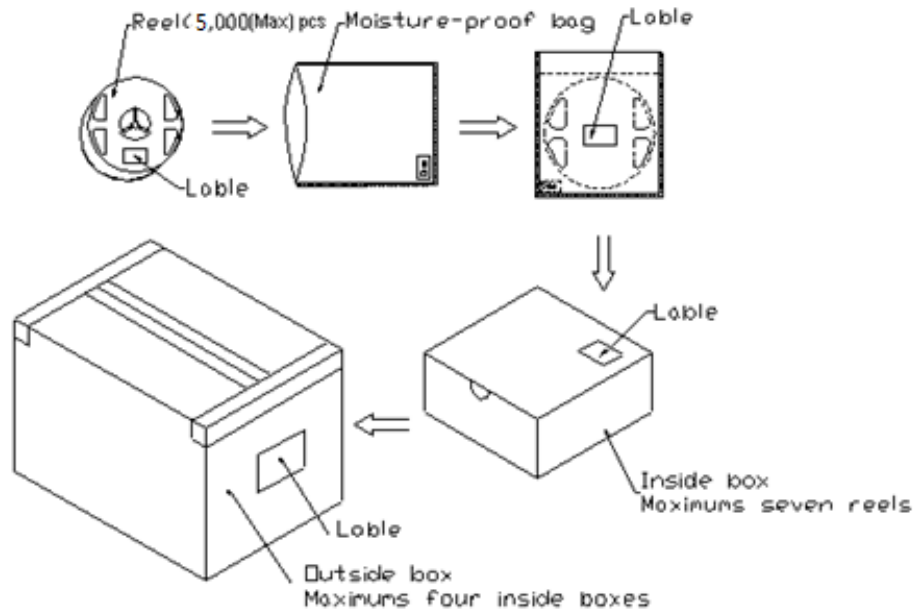

NOTES:

Reeled products [numbers of products are 5,000(Max)pcs] packed in a seal off moisture-proof bag along with a desiccant one by one, Seven moisture-proof bag of maximums [total maximum number of products are 35,000(Max)pcs] packed in an inside box (size: about 238mm x about 194mm x about 102mm) and four inside boxes of maximums are put in the outside box (size: about 410mm x about 254mm x about 229mm) Together with buffer material, and it is packed. (Part No., Lot No., quantity should appear on the label on the moisture-proof bag, part No. And quantity should appear on the label on the cardboard box.) The number of the loading steps of outside box (cardboard box) has it to three steps.



American Opto Plus LED Corp.

L199LWD-35K-TR

1.0 x 0.5 x 0.5mm 3500K White SMD LED

Forward Voltage Rank Combination (IF=20mA)

Rank	Min.	Max.	Unit
f	2.8	3.1	V
g	3.1	3.4	
h	3.4	3.7	

Luminous Intensity Rank Combination (IF=20mA)

Rank	Min.	Max.	Unit
L	160	200	mcd
M	200	250	
N	250	320	
O	320	400	
P	400	500	

Group Name on Label (Example DATA: gMB2 20)

DATA: gMB2 20	Vf(V)	Iv (mcd)	CIE(X,Y)	Test Condition
g→M→B2→20	3.1~3.4	200~250	X(0.392~0.412),Y(0.363~0.423)	IF=20mA

Notes:

1. The tolerance of luminous intensity (Iv) is ±15%
2. The tolerance of chromaticity coordinates is ±0.02
3. This specification is preliminary



American Opto Plus LED Corp.

L199LWD-35K-TR

1.0 x 0.5 x 0.5mm 3500K White SMD LED

Chromaticity coordinates Ranks combination (IF=20mA)

Rank	Chromaticity coordinates				
		X	Y	Z	u'
A1	X	0.372	0.372	0.392	0.392
	Y	0.363	0.393	0.423	0.393
A2	X	0.372	0.372	0.392	0.392
	Y	0.333	0.363	0.393	0.363
A3	X	0.372	0.372	0.392	0.392
	Y	0.303	0.333	0.363	0.333
B1	X	0.392	0.392	0.412	0.412
	Y	0.393	0.423	0.453	0.423
B2	X	0.392	0.392	0.412	0.412
	Y	0.363	0.393	0.423	0.393
B3	X	0.392	0.392	0.412	0.412
	Y	0.333	0.363	0.393	0.363
C1	X	0.412	0.412	0.432	0.432
	Y	0.423	0.453	0.483	0.453
C2	X	0.412	0.412	0.432	0.432
	Y	0.393	0.423	0.453	0.423
C3	X	0.412	0.412	0.432	0.432
	Y	0.363	0.393	0.423	0.393

