

Series: Low Profile Blade

Description: 3G/Active GNSS Blade Antenna

PART NUMBER: W4120GNSS5000



Features:

- 2-Feeds (3G, GNSS)
- GNSS Active Antenna
 - LNA gain 30dB
 - Pre and post LNA filtering
- Adhesive tape mount
- Size 136 x 37.7 x 13.8mm
- Connector SMA Male
- Cable 16.4 feet
- RoHS compliant

Applications:

- 3G 806-2170MHz
- GNSS (Beidou, GPS, Galileo, Glonass)
- Vehicular mounting
- Asset Tracking, Navigation, Fleet Management
- Mobile and Fixed broadband
- Utility boxes

All dimensions are in mm / inches

Issue: 1709

In the effort to improve our products, we reserve the right to make changes judged to be necessary.

CONFIDENTIAL AND PROPRIETARY INFORMATION

This document contains confidential and proprietary information of Pulse Electronics, Inc. (Pulse) and is protected by copyright, trade secret and other state and federal laws. Its receipt or possession does not convey any rights to reproduce, disclose its contents, or to manufacture, use or sell anything it may describe. Reproduction, disclosure or use without specific written authorization of Pulse is strictly forbidden.

For more information:

Pulse Worldwide Headquarters
15255 Innovation Drive #100
San Diego, CA 92128
USA
Tel: 1-858-674-8100

Pulse/Larsen Antennas
18110 SE 34th St Bldg 2 Suite 250
Vancouver, WA 98683
USA
Tel: 1-360-944-7551

Europe Headquarters
Pulse GmbH & Do, KG
Zeppelinstrasse 15
Herrenberg, Germany
Tel: 49 7032 7806 0

Pulse (Suzhou) Wireless Products Co, Inc.
99 Huo Ju Road(#29 Bldg,4th Phase
Suzhou New District
Jiangsu Province, Suzhou 215009 PR China
Tel: 86 512 6807 9998



Description: 3G/Active GNSS Blade Antenna

Series: Low Profile Blade

PART NUMBER: W4120GNSS5000

ELECTRICAL SPECIFICATIONS

Frequency(LTE Cable)	806-960/1710-2170	MHz
	1561.098 ± 2.046/	
Frequency(GNSS cable)	1575.42 ± 1.023/	MHz
	1602.5625 ± 4	
Nominal Impedance	50	Ω
VSWR (LTE)*	2.5:1	Max
VSWR (GNSS)*	2:1	Max
Peak Gain (LTE,698-960MHz,Typical)**	1.7	dBi
Peak Gain (LTE,1710-2700MHz,Typical)**	2.9	dBi
Efficiency (LTE,698-960MHz,Typical)**	55	%
Efficiency (LTE,1710-2700MHz,Typical)**	75	%
HPBW / Horizontal Plane (LTE/WiFi)**		Omni
HPBW / Vertical Plane (LTE, 698-960MHz, Typical)**		32°
HPBW / Vertical Plane (LTE,1710-2700MHz, Typical)**		50°
Polarization (LTE)		Vertical
Polarization (GNSS)		RHCP
RHCP Peak Gain (GNSS Radiating element, Typical)***	1	dBic
Gain (LNA gain)	30	dB ± 2 dB
Out of Band Rejection		
698 MHz	>70	dB
960MHz	>65	dB
1710MHz	>60	dB
2170MHz	>65	dB
2400MHz	>65	dB
2700MHz	>65	dB

Issue: 1709

In the effort to improve our products, we reserve the right to make changes judged to be necessary.

CONFIDENTIAL AND PROPRIETARY INFORMATION

This document contains confidential and proprietary information of Pulse Electronics, Inc. (Pulse) and is protected by copyright, trade secret and other state and federal laws. Its receipt or possession does not convey any rights to reproduce, disclose its contents, or to manufacture, use or sell anything it may describe. Reproduction, disclosure or use without specific written authorization of Pulse is strictly forbidden.

Series: Low Profile Blade

Description: 3G/Active GNSS Blade Antenna

PART NUMBER: W4120GNSS5000

ELECTRICAL SPECIFICATIONS

Noise Figure	<2.4 dB
Operating Voltage	3.3-5 Vdc±0.5V
Current Consumption	9 mA± 2 mA

MECHANICAL SPECIFICATIONS

Overall size	136 x 37.7 x 13.8mm
Weight	194g
Antenna Color	black
Connector type	SMA male
Cable type (LTE)	RG174
Cable type (GNSS)	RG174
Cable length	16.4' (5 m)

ENVIRONMENTAL SPECIFICATIONS

Operating Temperature	-40/+85 ° C
Storage Temperature	-40/+85 ° C
Ingress Protection	IP67
Wind-loading	100mph
RoHS Compliant	Yes

OTHER SPECIFICATIONS

Mounting	Adhesive Tape
Radome Material	PC/PET, UV resistant

Issue: 1709

In the effort to improve our products, we reserve the right to make changes judged to be necessary.

CONFIDENTIAL AND PROPRIETARY INFORMATION

This document contains confidential and proprietary information of Pulse Electronics, Inc. (Pulse) and is protected by copyright, trade secret and other state and federal laws. Its receipt or possession does not convey any rights to reproduce, disclose its contents, or to manufacture, use or sell anything it may describe. Reproduction, disclosure or use without specific written authorization of Pulse is strictly forbidden.

Description: 3G/Active GNSS Blade Antenna

Series: Low Profile Blade

PART NUMBER: W4120GNSS5000

MECHANICAL DRAWING

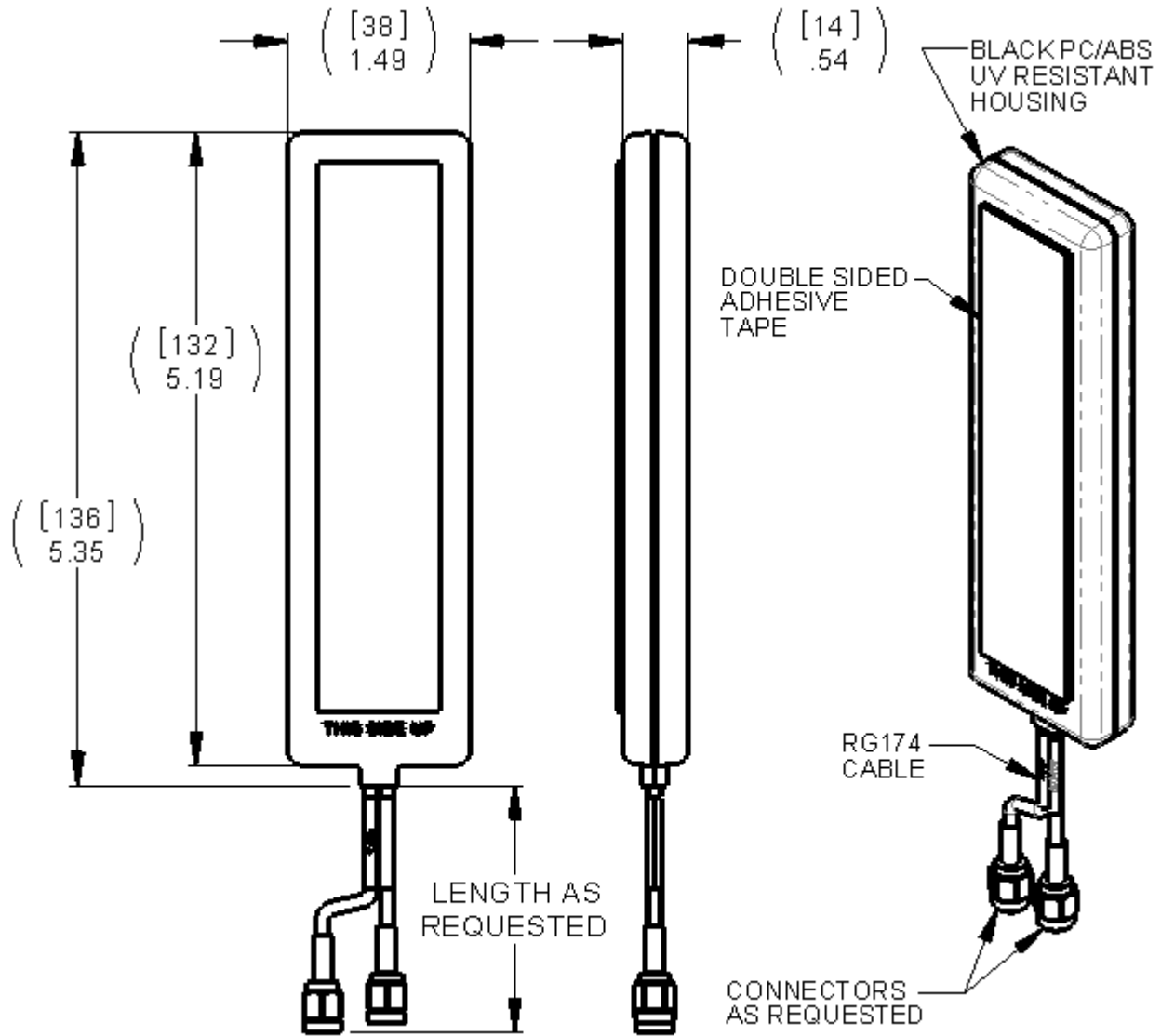

Issue: 1709

In the effort to improve our products, we reserve the right to make changes judged to be necessary.

CONFIDENTIAL AND PROPRIETARY INFORMATION

This document contains confidential and proprietary information of Pulse Electronics, Inc. (Pulse) and is protected by copyright, trade secret and other state and federal laws. Its receipt or possession does not convey any rights to reproduce, disclose its contents, or to manufacture, use or sell anything it may describe. Reproduction, disclosure or use without specific written authorization of Pulse is strictly forbidden.

Series: Low Profile Blade

Description: 3G/Active GNSS Blade Antenna

PART NUMBER: W4120GNSS5000

Test Setup

*VSWR is tested with 5m cable in free space

** Radiation Performance is tested with 200mm cable in free space

***GNSS module is tested on 70X70mm ground plane

Description: 3G/Active GNSS Blade Antenna

Series: Low Profile Blade

PART NUMBER: W4120GNSS5000

CHARTS

VSWR of 3G antenna

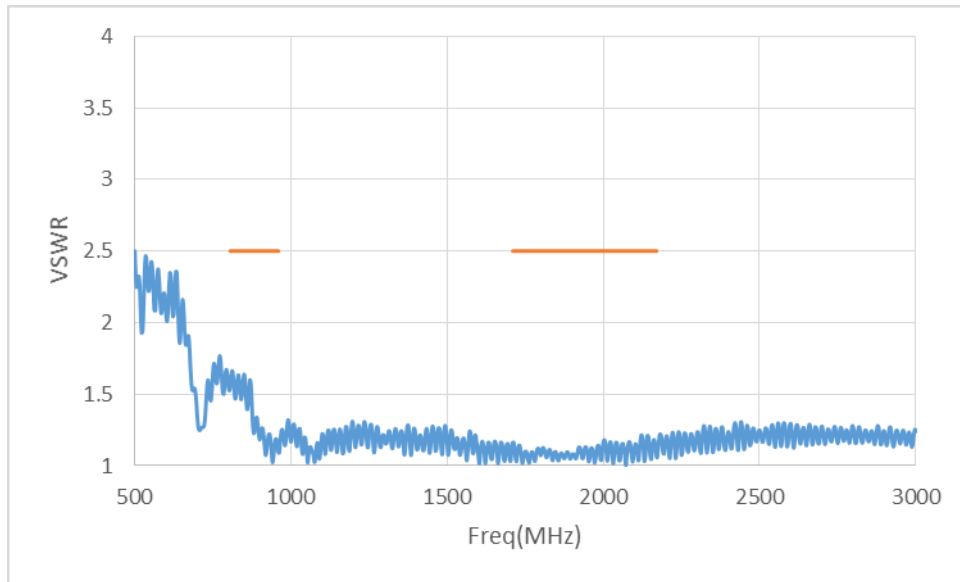

Radiation efficiency of 3G antenna

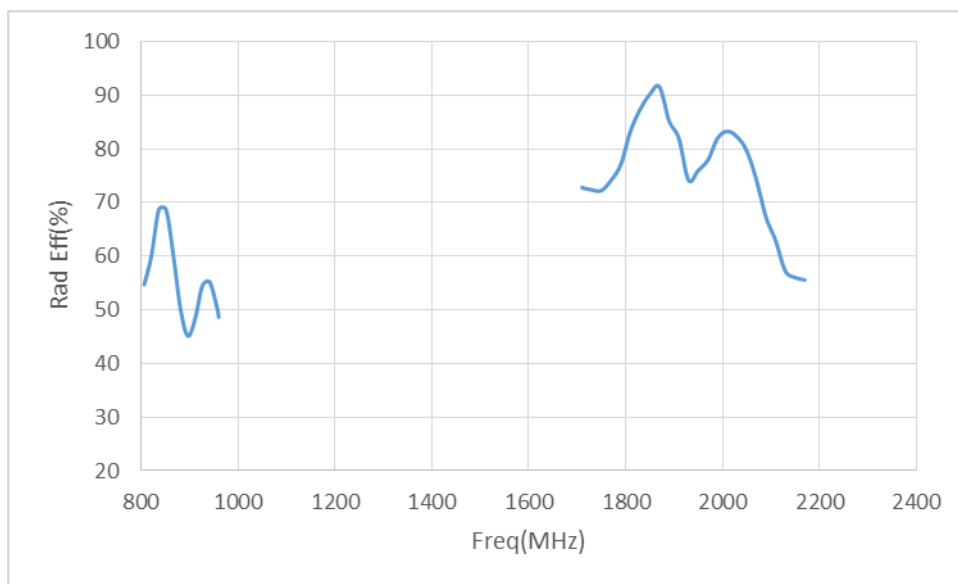

Issue: 1709

In the effort to improve our products, we reserve the right to make changes judged to be necessary.

CONFIDENTIAL AND PROPRIETARY INFORMATION

This document contains confidential and proprietary information of Pulse Electronics, Inc. (Pulse) and is protected by copyright, trade secret and other state and federal laws. Its receipt or possession does not convey any rights to reproduce, disclose its contents, or to manufacture, use or sell anything it may describe. Reproduction, disclosure or use without specific written authorization of Pulse is strictly forbidden.

Description: 3G/Active GNSS Blade Antenna

Series: Low Profile Blade

PART NUMBER: W4120GNSS5000

CHARTS

Peak Gain of 3G antenna

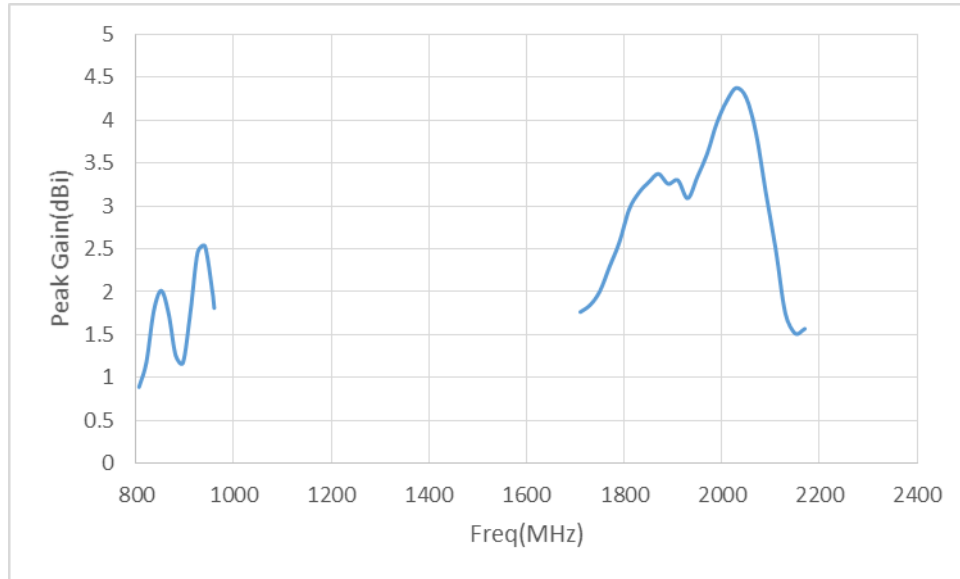

3G antenna X-Y plane radiation pattern at 3G low band

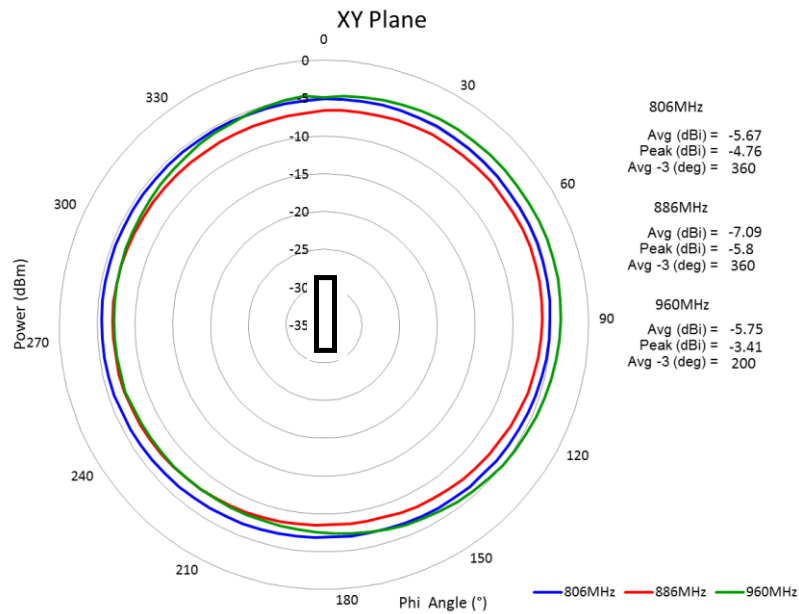

Issue: 1709

In the effort to improve our products, we reserve the right to make changes judged to be necessary.

CONFIDENTIAL AND PROPRIETARY INFORMATION

This document contains confidential and proprietary information of Pulse Electronics, Inc. (Pulse) and is protected by copyright, trade secret and other state and federal laws. Its receipt or possession does not convey any rights to reproduce, disclose its contents, or to manufacture, use or sell anything it may describe. Reproduction, disclosure or use without specific written authorization of Pulse is strictly forbidden.

Description: 3G/Active GNSS Blade Antenna

Series: Low Profile Blade

PART NUMBER: W4120GNSS5000

CHARTS

3G antenna Z-X plane radiation pattern at 3G low band

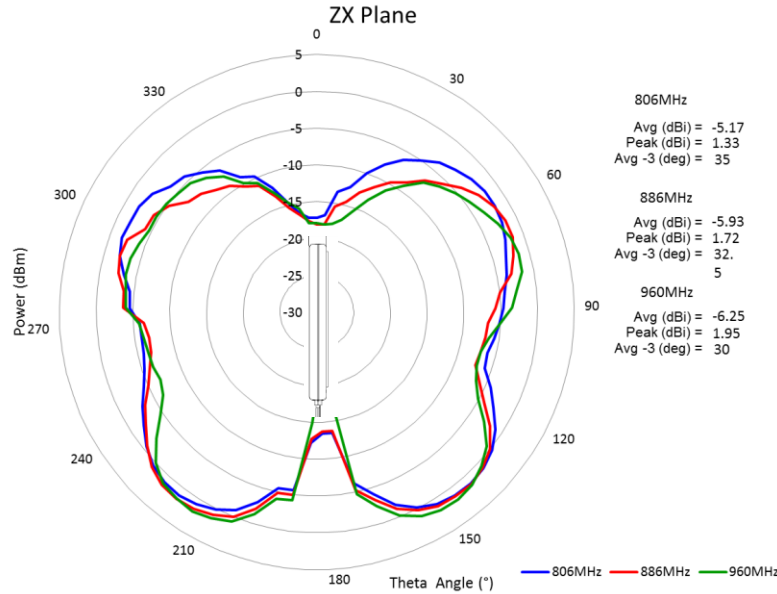

3G antenna Y-Z plane radiation pattern at 3G low band

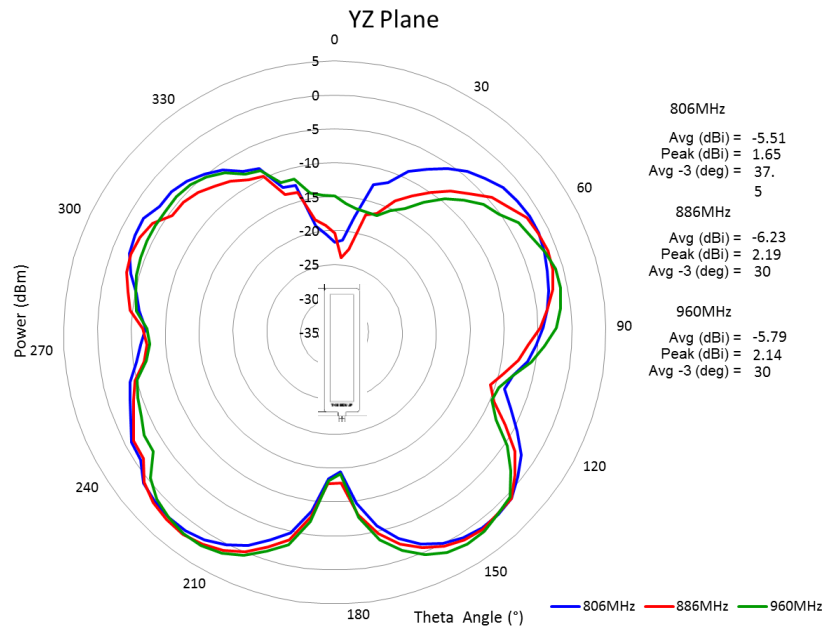

Issue: 1709

In the effort to improve our products, we reserve the right to make changes judged to be necessary.

CONFIDENTIAL AND PROPRIETARY INFORMATION

This document contains confidential and proprietary information of Pulse Electronics, Inc. (Pulse) and is protected by copyright, trade secret and other state and federal laws. Its receipt or possession does not convey any rights to reproduce, disclose its contents, or to manufacture, use or sell anything it may describe. Reproduction, disclosure or use without specific written authorization of Pulse is strictly forbidden.

Description: 3G/Active GNSS Blade Antenna

Series: Low Profile Blade

PART NUMBER: W4120GNSS5000

CHARTS

3G antenna X-Y plane radiation pattern at 3G high band

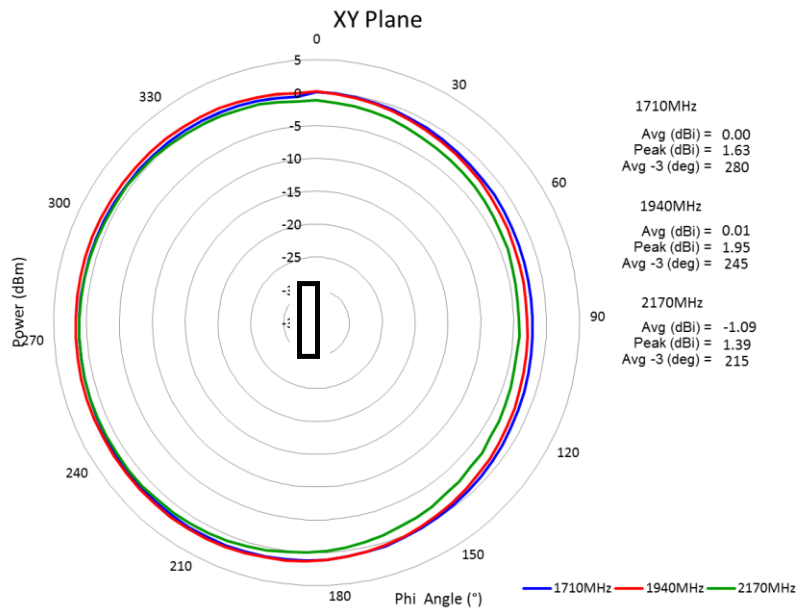

3G antenna Z-X plane radiation pattern at 3G high band

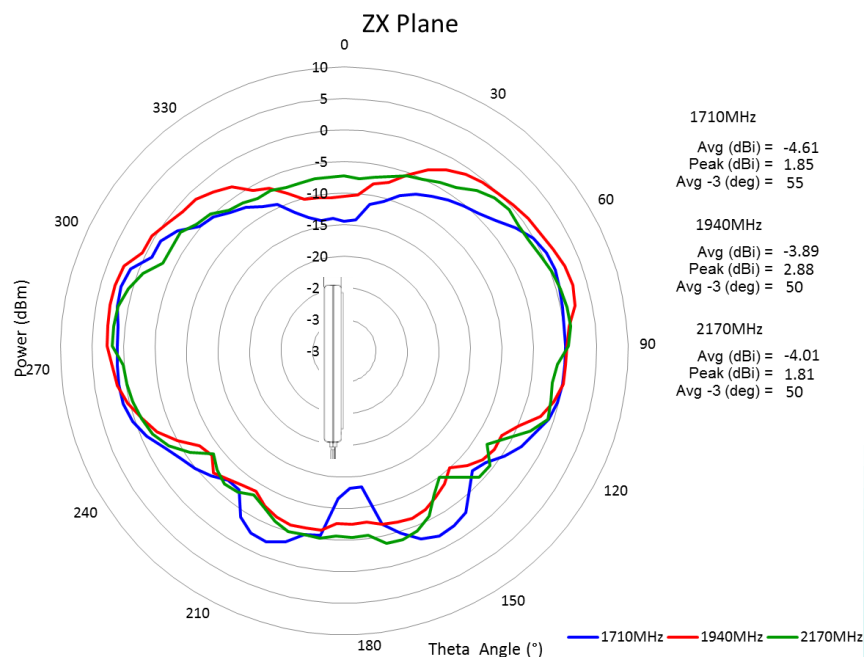

Issue: 1709

In the effort to improve our products, we reserve the right to make changes judged to be necessary.

CONFIDENTIAL AND PROPRIETARY INFORMATION

This document contains confidential and proprietary information of Pulse Electronics, Inc. (Pulse) and is protected by copyright, trade secret and other state and federal laws. Its receipt or possession does not convey any rights to reproduce, disclose its contents, or to manufacture, use or sell anything it may describe. Reproduction, disclosure or use without specific written authorization of Pulse is strictly forbidden.

Description: 3G/Active GNSS Blade Antenna

Series: Low Profile Blade

PART NUMBER: W4120GNSS5000

CHARTS

3G antenna Y-Z plane radiation pattern at 3G high band

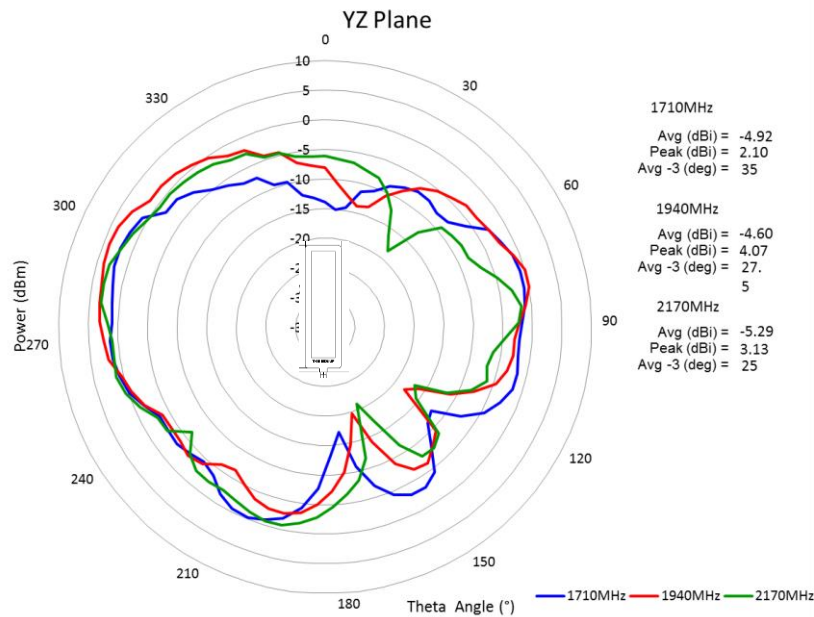

LNA Gain and out-of-band rejection

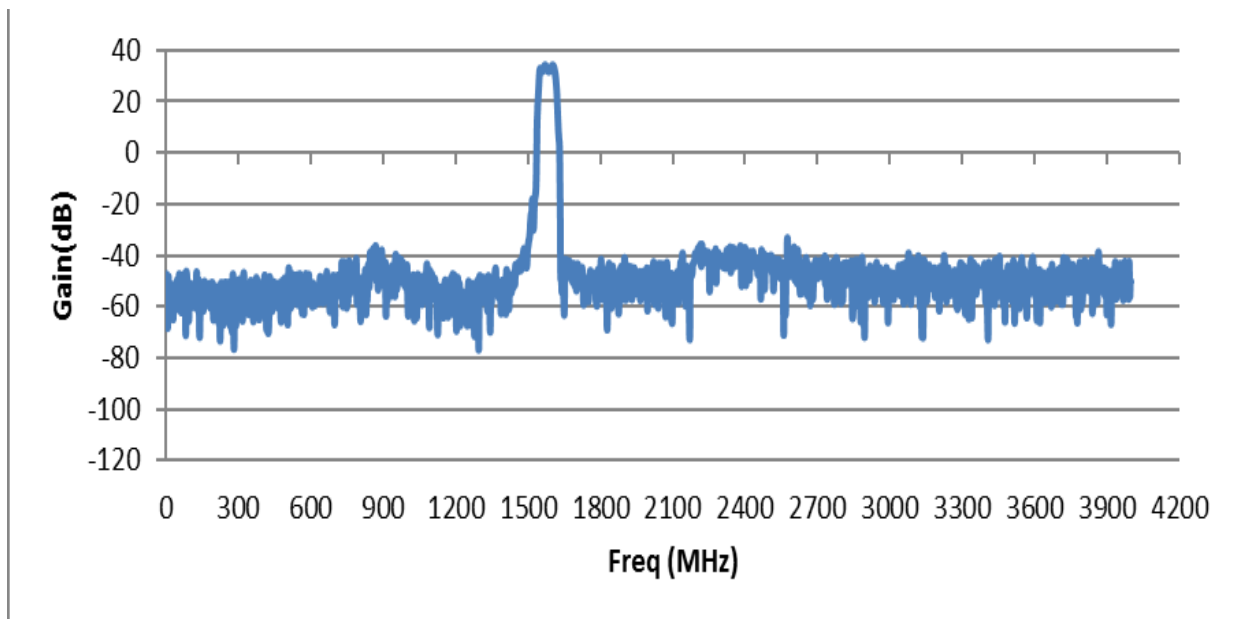

Issue: 1709

In the effort to improve our products, we reserve the right to make changes judged to be necessary.

CONFIDENTIAL AND PROPRIETARY INFORMATION

This document contains confidential and proprietary information of Pulse Electronics, Inc. (Pulse) and is protected by copyright, trade secret and other state and federal laws. Its receipt or possession does not convey any rights to reproduce, disclose its contents, or to manufacture, use or sell anything it may describe. Reproduction, disclosure or use without specific written authorization of Pulse is strictly forbidden.

Series: Low Profile Blade

Description: 3G/Active GNSS Blade Antenna

PART NUMBER: W4120GNSS5000

CHARTS

Radiation Pattern (70mm x 70mm ground plane) GPS & Galileo

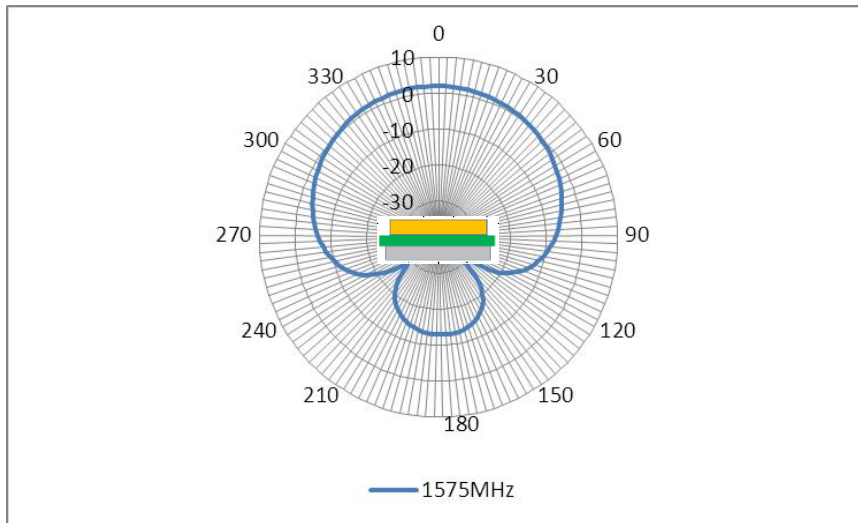

Radiation Pattern (70mm x 70mm ground plane) GLONASS

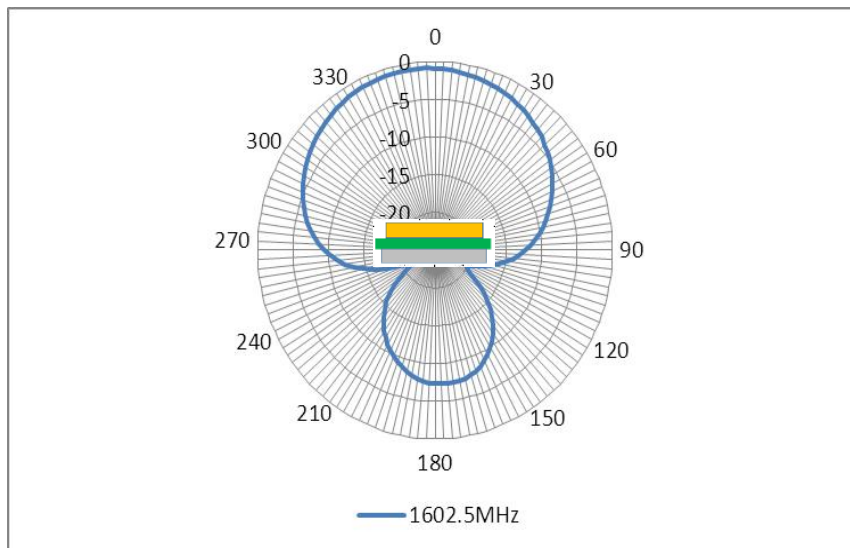

Issue: 1709

In the effort to improve our products, we reserve the right to make changes judged to be necessary.

CONFIDENTIAL AND PROPRIETARY INFORMATION

This document contains confidential and proprietary information of Pulse Electronics, Inc. (Pulse) and is protected by copyright, trade secret and other state and federal laws. Its receipt or possession does not convey any rights to reproduce, disclose its contents, or to manufacture, use or sell anything it may describe. Reproduction, disclosure or use without specific written authorization of Pulse is strictly forbidden.

Series: Low Profile Blade

Description: 3G/Active GNSS Blade Antenna

PART NUMBER: W4120GNSS5000

CHARTS

Radiation Pattern (70mm x 70mm ground plane) BD2

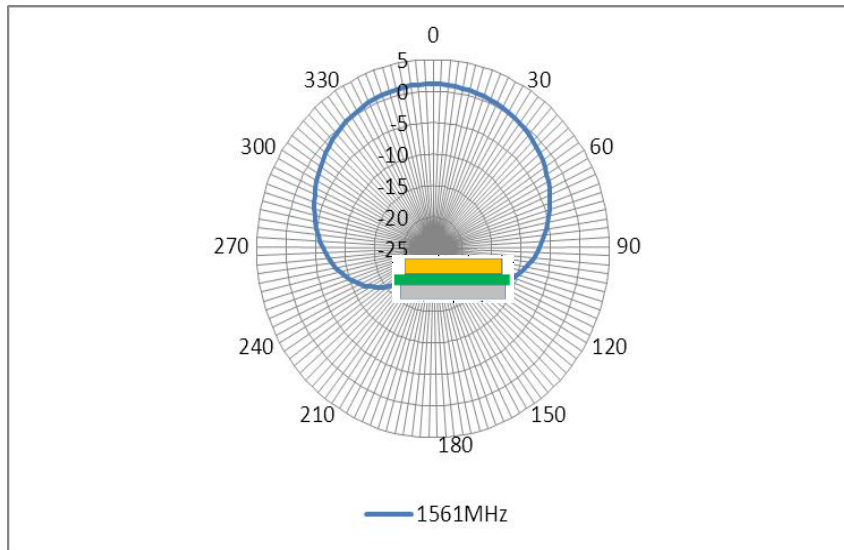

Series: Low Profile Blade

Description: 3G/Active GNSS Blade Antenna

PART NUMBER: W4120GNSS5000

PACKAGING

56pcs antennas per package box

56pcs PE bags per package box

1pcs antenna per PE bag

Package box: 440mm*292mm*310mm