

# SRBP-80A2P0

## Non-Isolated DC-DC Converter

The SRBP-80A2P0 is a 2-phase non-isolated step-down digital DC/DC converter providing up to 80 A of output current.

All operating features can be configured through Power Management bus. The output voltage range is from 0.6 VDC to 5.2 VDC over a wide range of input voltage from 7.5 VDC to 14 VDC.

The module is provided in a quite small dimension SMD package of (L x W x H): 1 x 0.5 x 0.48 [inch] / 25.4 x 12.7 x 12.2 [mm].



### Key Features & Benefits

- 7.5 – 14 VDC Input / 0.6 - 5.2 VDC @ 80 A (single) or 40 A (dual) Output
- Non-isolated Digital DC-DC Converter with Power Management bus
- Two Phase Design, Dual or Single Output Configurable
- High Efficiency
- High Power Density
- Output Over-Voltage Protection
- Over Temperature Protection
- Remote On/Off
- Undervoltage Lockout
- Over Current and Short Circuit Protection
- 2-Wire Remote Sense
- Wide Trim
- Parallelable Up To 8 Phase
- Small Dimension SMD Package
- Class II, Category 2, Non-Isolated DC/DC Converter (refer to IPC-9592B)



### Applications

- Networking
- Computers and Peripherals
- Telecommunications

## 1. MODEL SELECTION

MODEL NUMBER	OUTPUT VOLTAGE	INPUT VOLTAGE	MAX. OUTPUT CURRENT	MAX. OUTPUT POWER	TYPICAL EFFICIENCY
SRPB-80A2P0	0.6 – 5.2 V	7.5 - 14 V	80 A	200 W	90% (11Vin,1.0V/80Aout)

**NOTE:** Add "G" suffix at the end of the model number to indicate Tray Packaging.  
Add "R" suffix to indicate Tape & Reel package.

### PART NUMBER EXPLANATION

S	R	BP	-	80	A	2P	0	x
Mounting Type	RoHS Status	Series Name		Output Current	Input Range	Output Voltage	Active Logic	Package Type
SMD	RoHS	POL		80A	7.5 – 14 V	0.6 – 5.2 V	Active High	G – Tray package R – T&R package

## 2. ABSOLUTE MAXIMUM RATINGS

PARAMETER	DESCRIPTION	MIN	TYP	MAX	UNITS
Continuous non-operating Input Voltage		-0.3	-	15	V
Output Voltage		0.6	-	5.2	V
SHARE, EN1, EN2, PG1, PG2, ADDR, SCL, SDA, SALERT, SYNC, CFG, ASCR, Vtrim1, Vtrim2, Terminal Voltage		-0.3	-	5.5	V
VS0+, VS0-, VS1+, VS1-,		-0.3	-	6.0	V
Ambient Temperature		-40	-	85	°C
Storage Temperature		-40	-	125	°C
Altitude		-	-	3000	m

**NOTE:** Ratings used beyond the maximum ratings may cause a reliability degradation of the converter or may permanently damage the device.

## 3. INPUT SPECIFICATIONS

All specifications are typical at 25°C unless otherwise state

PARAMETER	DESCRIPTION	MIN	TYP	MAX	UNITS
Operating Input Voltage	Vout=0.6 - 3.3 V	7.5	11	14	V
Input Current	Vin = 7.5 V, Vout = 3.3 V Iout = 60 A, Fsw = 457 kHz, Tamb = 55°C, 200 LFM	-	-	33	A
Input Current under Disable	Enable off	-	40	60	mA
Input Capacitance (Internal)	16 x 10 µF/16 V Ceramic Cap	-	160	-	µF
Input Capacitance (Recommended External)	2x 47 µF / 25 V Polymer Cap and 4x 10 µF / 16 V Ceramic Cap	-	140	-	µF
Turn on Voltage Threshold		-	6.8	-	V
Turn off Voltage Threshold		-	6.1	-	V
Logic Input Low		-	-	0.8	V
Logic Input High		2.0	-	-	V
Logic Output Low	2 mA Sinking	-	-	0.5	V
Logic Output High	2 mA Sourcing	2.25	-	-	V
Logic Input Leakage Current		-100	-	+100	nA

**CAUTION:** All specifications are typical at nominal input, full load at 25°C unless noted.

## 4. OUTPUT SPECIFICATIONS

All specifications are typical at nominal input, full load at 25°C unless otherwise stated.

PARAMETER	DESCRIPTION	MIN	TYP	MAX	UNITS
Output Voltage		0.6	-	5	V
Output Voltage Set Point Accuracy	$I_{out}=50\%$ $I_{outmax}$ , with +/-1% $R_{vtrim}$ , Measured at $VS_{x+}$ and $VS_{x-}$	-1	-	1	%
Line Regulation	0.6-1.0V	-	2	-	mV
	1.0-5.0V	-	0.2	-	%
Load Regulation	0.6-1.0V in Single Output Mode	-	5	-	mV
	1.0-5.0V in Single Output Mode	-	0.5	-	%
	0.6-1.0V in Dual Output Mode	-	5	-	mV
	1.0-5.0V in Dual Output Mode	-	0.5	-	%
	0.6-2.5V in 4-phase Mode	-	32	-	mV
	3.3V in 4-phase Mode	-	24	-	mV
	5.0V in 4-phase Mode	-	16	-	mV
	0.6-2.5V in 6-phase Mode	-	48	-	mV
	3.3V in 6-phase Mode	-	36	-	mV
	5.0V in 6-phase Mode	-	24	-	mV
	0.6-2.5V in 8-phase Mode	-	64	-	mV
	3.3V in 8-phase Mode	-	48	-	mV
5.0V in 8-phase Mode	-	32	-	mV	
Regulation Over Temperature (-40°C - 85°C)		-	10	-	mV
Output Ripple and Noise with Minimum Cout	$V_{out}=0.6V$ to $1.0V$ in Single Output Mode	-	25	-	mV
	$V_{out}=0.6V$ to $1.0V$ in Dual Outputs Mode	-	20	-	mV
	$V_{out}=1.8V$ in Single Output Mode	-	45	-	mV
	$V_{out}=1.8V$ in Dual Outputs Mode	-	35	-	mV
	$V_{out}=2.5V$ in Single Output Mode	-	65	-	mV
	$V_{out}=2.5V$ in Dual Outputs Mode	-	55	-	mV
	$V_{out}=3.3V$ in Single Output Mode	-	95	-	mV
	$V_{out}=3.3V$ in Dual Outputs Mode	-	85	-	mV
	$V_{out}=5V$ in Single Output Mode	-	120	-	mV
	$V_{out}=5V$ in Dual Outputs Mode	-	100	-	mV
Output Current Range	$V_{out}=0.6V$ to $1.0V$ in Single Output Mode	0	-	80	A
	$V_{out}=0.6V$ to $1.0V$ in Dual Outputs Mode	0	-	40	A
	$V_{out}=1.8V$ in Single Output Mode	0	-	70	A
	$V_{out}=1.8V$ in Dual Outputs Mode	0	-	35	A
	$V_{out}=2.5V$ in Single Output Mode	0	-	65	A
	$V_{out}=2.5V$ in Dual Outputs Mode	0	-	32.5	A
	$V_{out}=3.3V$ in Single Output Mode	0	-	60	A
	$V_{out}=3.3V$ in Dual Outputs Mode	0	-	30	A
	$V_{out}=5V$ in Single Output Mode	0	-	40	A
	$V_{out}=5V$ in Dual Outputs Mode	0	-	20	A
Ton Ramp/Toff Ramp Time	Default	-	5	-	ms
Ton Delay/Toff Delay	Default	-	5	-	ms
Ton Delay/Toff Delay Range	Set by Power Management bus	2	-	5000	ms
Power-good Delay	Default	-	1	-	ms
Power-good Delay Range	Set by Power Management bus	0	-	5000	ms
Transient Response	11Vin, 1Vout, 50% Load to 75% Load to 50% Load, 1A/us with Minimum Cout	-	30	-	mV
	Minimum Cout 2*220uF/6.3V Polymer Cap and 3*100uF/6.3V Ceramic Cap	-	100	-	µs
Output Capacitance per Phase	Minimum Cout 2*220uF/6.3V Polymer Cap and 3*100uF/6.3V Ceramic Cap	740	2320	4700	µF

## 5. GENERAL SPECIFICATION

PARAMETER	DESCRIPTION	MIN	TYP	MAX	UNITS
<i>General Specifications</i>					
Efficiency	Full load 1 Vout	-	90	-	%
	Full load 1.8 Vout	-	93	-	%
	Full load 2.5 Vout	-	94.5	-	%
	Full load 3.3 Vout	-	95	-	%
	Full load 5 Vout	-	95.5	-	%
Power Management Bus Clock Frequency		100	-	400	kHz
Switching Frequency	RSYNC=23.7 kohm	-	457	-	kHz
Configurable Switching Frequency		400	-	800	kHz
Over Temperature Protection		-	120	-	°C
Weight		-	9.5	-	g
MTBF	Vin=11 V, Vo=1 V, Io=80 A with 200 LFM, Ta=40°C	-	45,283,015	-	Hours
Dimensions (L x W x H)			1 x 0.5 x 0.48		inch
			25.4 x 12.7 x 12.2		mm
<i>Control/Supervisory Specifications</i>					
ENABLE					
Signal Low	ENABLE pin open, unit on default.	-0.3	-	0.8	V
Signal High		2	-	5	V

### Enable

The enable pins (EN1 and EN2) are used to enable and disable Vo1 and Vo2 separately. When working in Single Output Mode, use only EN1 and ground EN2.

The Enable pins should be held LOW whenever a configuration file, or script is used to configure the module, or a Power Management Bus command is sent to prevent potential damage to application circuit. When the module is used in a self-enabled mode, for example, when EN1 or EN2 is tied to an external 5V, or to a resistor divider to VIN, the user must consider the module's default factory settings. When a configuration file is used to configure the module, the factory default settings are restored to both the user and default stores in order to set the module to an initialized state. Since the default state of the module is to be enabled when the enable pin is high, it is possible for the module to be enabled while the Power Management bus commands are sent to the module during the configuration process.

The Enable pin is edge triggered to achieve fast turn-off times. As a result, minimum Enable high and Enable low pulse widths must be observed to ensure correct operation. The minimum high and low pulse widths are dependent on the configured rise, fall and delay times and can be calculated:

$$\text{EN low} > \text{TOFF\_DELAY} + \text{TOFF\_FALL} + 10.5\text{ms}$$

$$\text{EN high} > \text{TON\_DELAY} + \text{TON\_RISE} + \text{POWER\_GOOD\_DELAY} + 5.5\text{ms}$$

EN low and EN high times shorter than these minimums may result in the module not responding to the trailing edge of the pulse. For example, a EN low pulse below the EN low minimum pulse width may stay in the OFF state until a valid EN low pulse is applied to the EN pin.

6. EFFICIENCY DATA

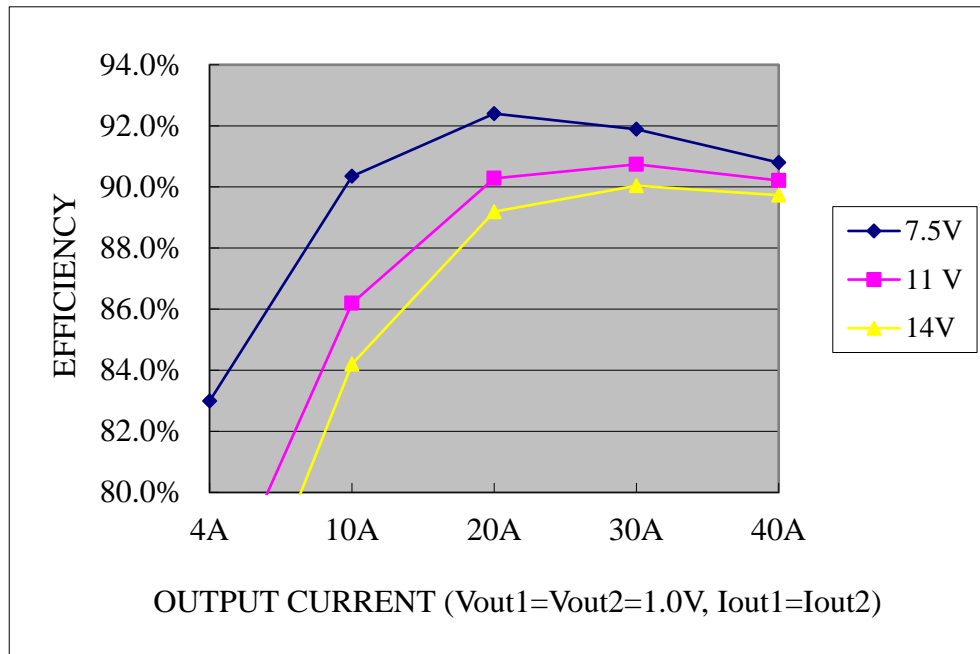

Figure 1. Efficiency data-1

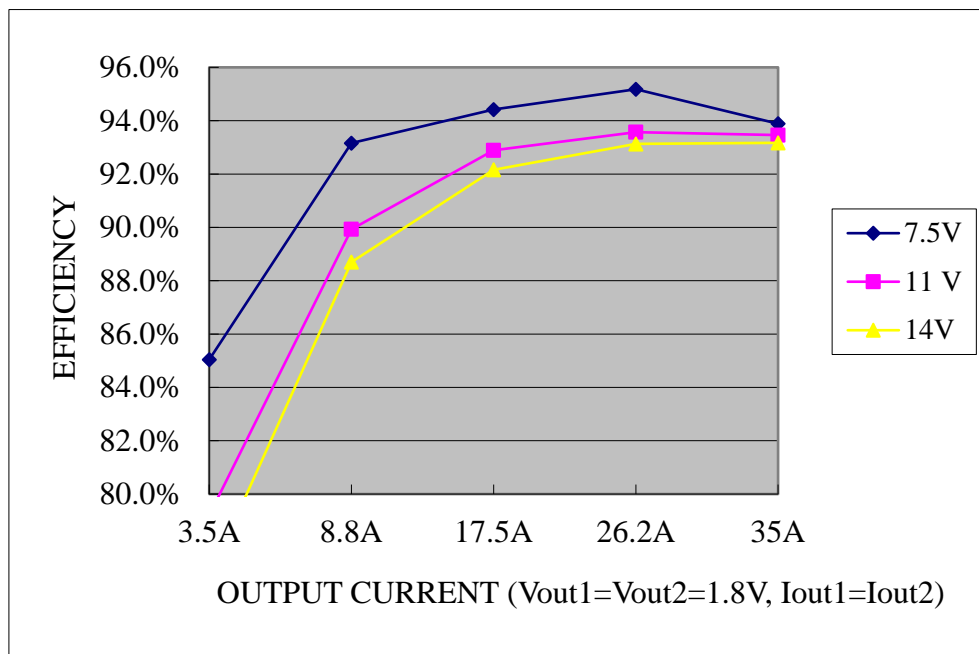

Figure 2. Efficiency data-2

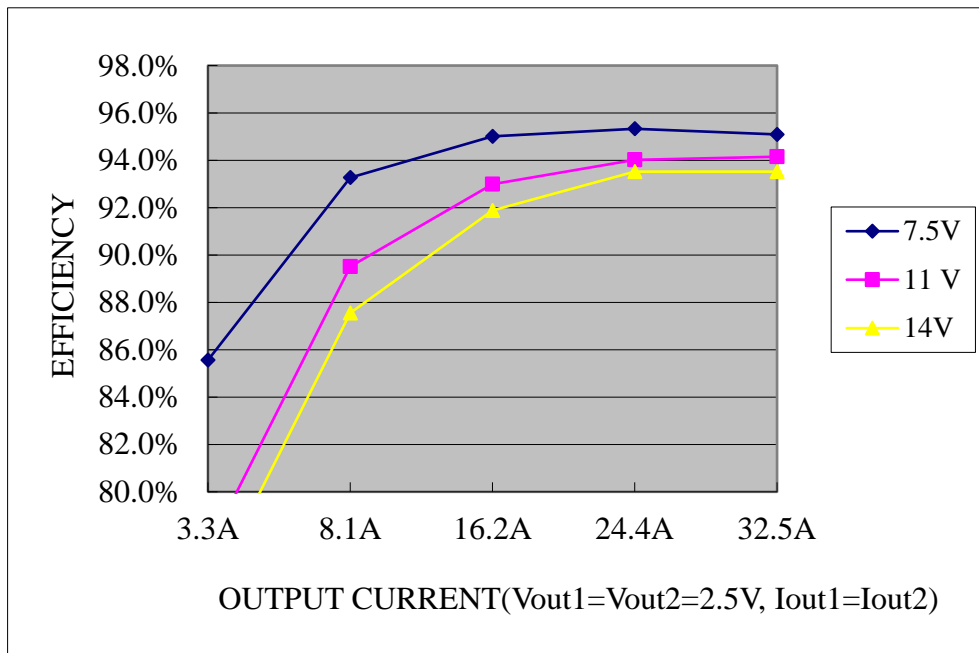

Figure 3. Efficiency data-3

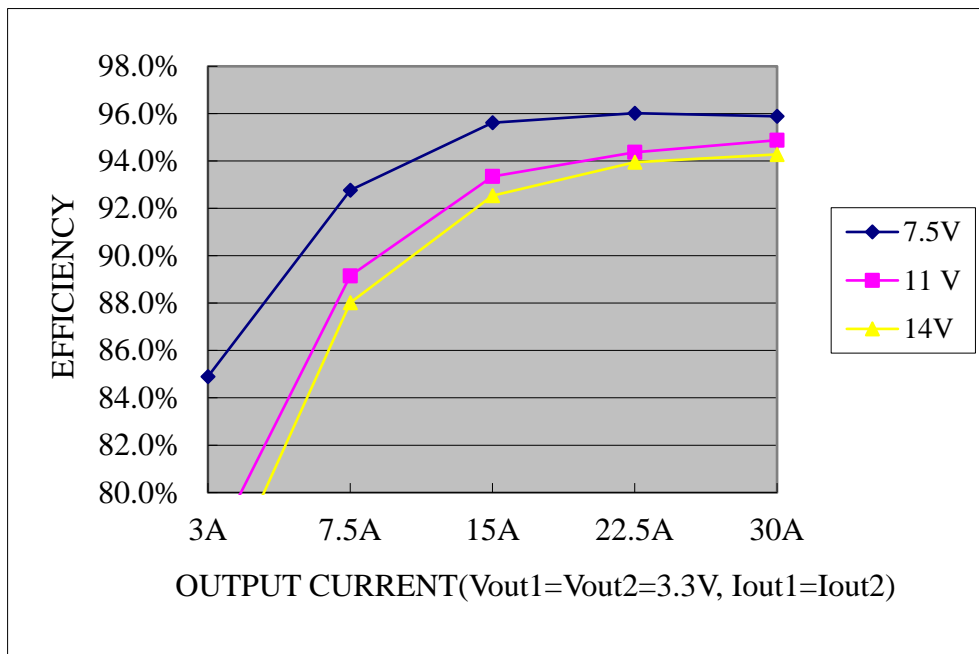

Figure 4. Efficiency data-4

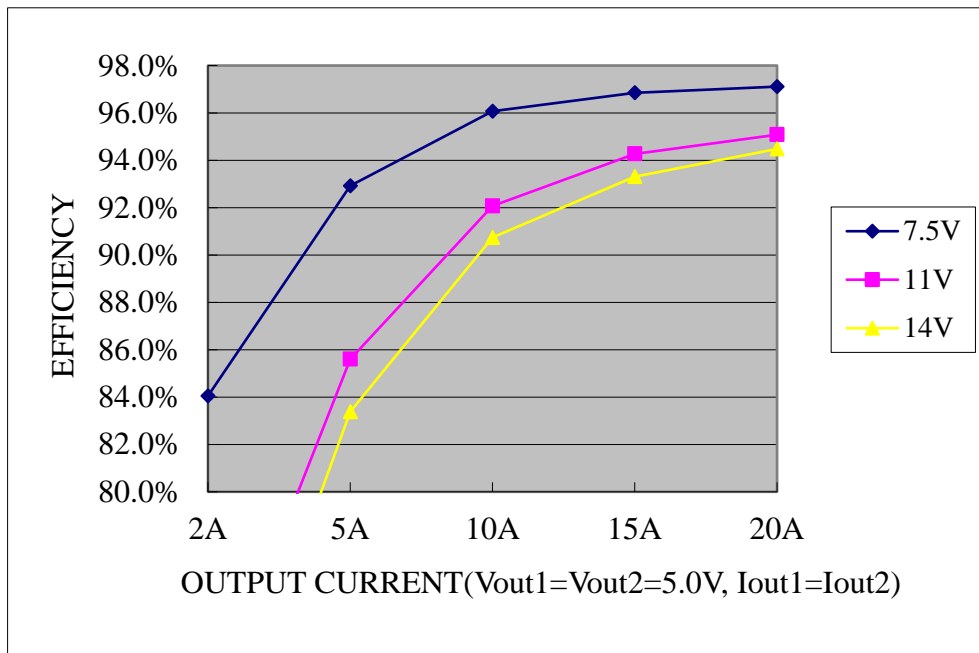

Figure 5. Efficiency data-5

## 7. INPUT REFLECTED RIPPLE CURRENT

### TEST SETUP

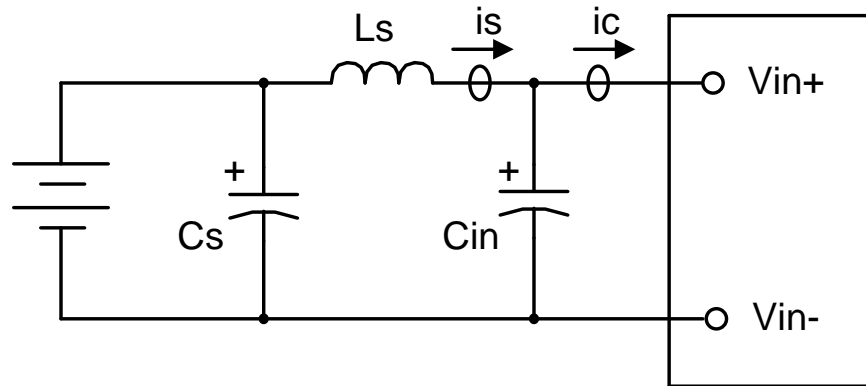

Figure 6.

Notes and values in testing.

$i_s$ : Simulated Source Impedance

$i_c$ : Input Terminal Ripple Current

$L_s$ : Offset possible source Impedance ( $1\mu\text{F}$ )

$C_{in}$ : Capacitors should be as closed as possible to the power module to damped  $i_c$  ripple current and enhance stability.

Recommendation: 1\*1000uF/16V Aluminum electrolytic, 16YXF1000+1\*330uF/16V OS-CON, 16SVP330M+3\*22uF/16V/1210

Below measured waveforms are based on above simulated and recommended inductance and capacitance.

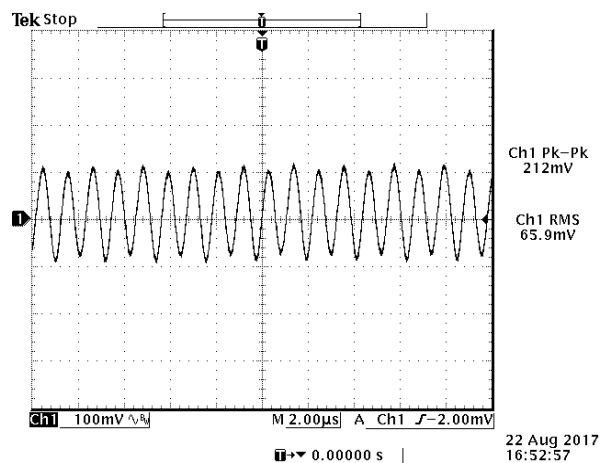

Figure 7.  $i_s$  (input reflected ripple current), AC component



8. THERMAL DERATING CURVE

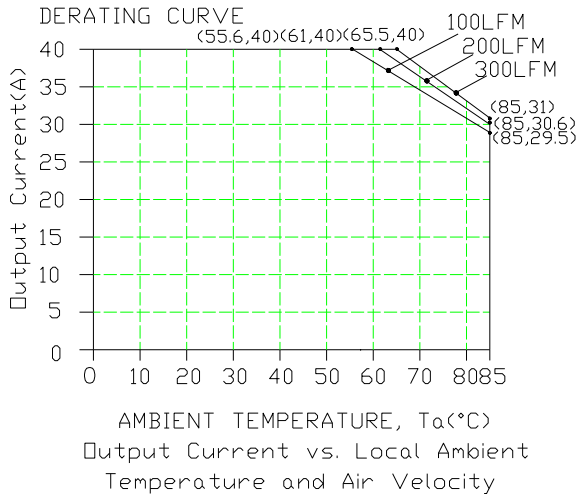

Figure 8. Test Condition:  $V_{out1} = 1.0V/40A$ ,  $V_{out2} = 1.0V/40A$  at  $V_{in}=11V@T_a=25^{\circ}C$

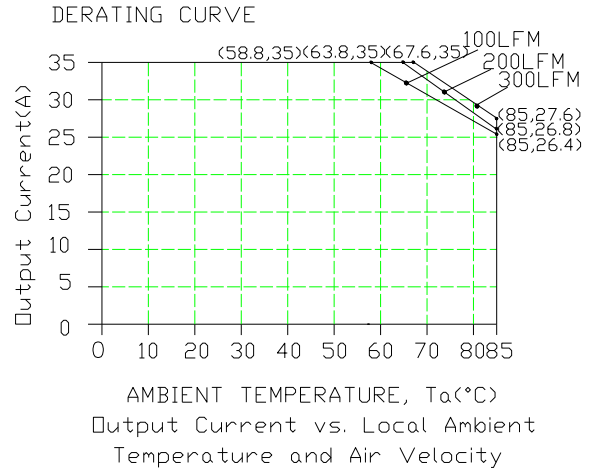

Figure 9. Test Condition:  $V_{out1} = 1.8V/35A$ ,  $V_{out2} = 1.8V/35A$  at  $V_{in}=11V@T_a=25^{\circ}C$

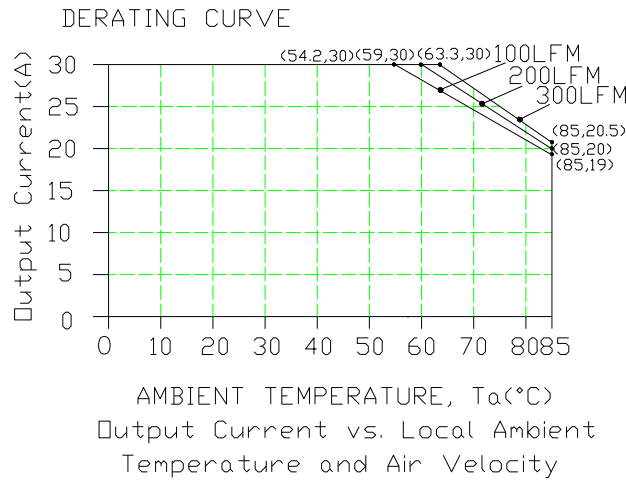

Figure 10. Test Condition:  $V_{out1} = 3.3V/30A$ ;  $V_{out2} = 3.3V/30A$  at  $V_{in}=11V@T_a=25^{\circ}C$

9. RIPPLE AND NOISE WAVEFORM

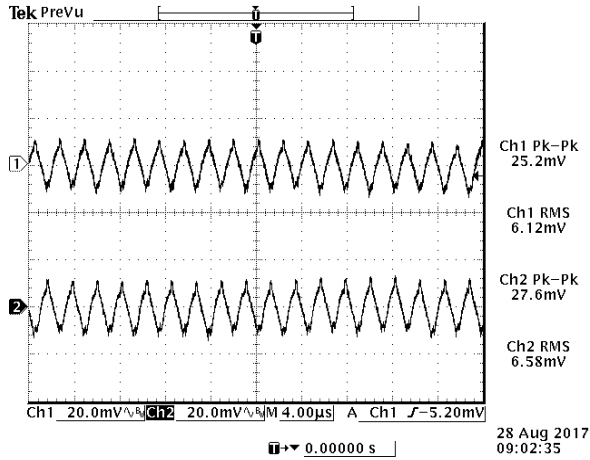

Figure 11.

**NOTE:** Ripple and noise at full load,  $V_{in}=11V$ ,  $V_o=1.0V$ , 0-20MHz BW, with 3\*100uF ceramic and 2\*220uF polymer capacitors at the output,  $T_a=25^\circ C$ .

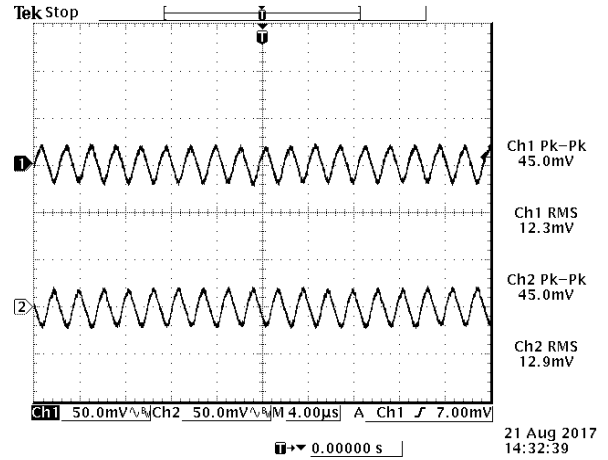

Figure 12.

**NOTE:** Ripple and noise at full load,  $V_{in}=11V$ ,  $V_o=1.8V$ , 0-20MHz BW, with 3\*100uF ceramic and 2\*220uF polymer capacitors at the output,  $T_a=25^\circ C$ .

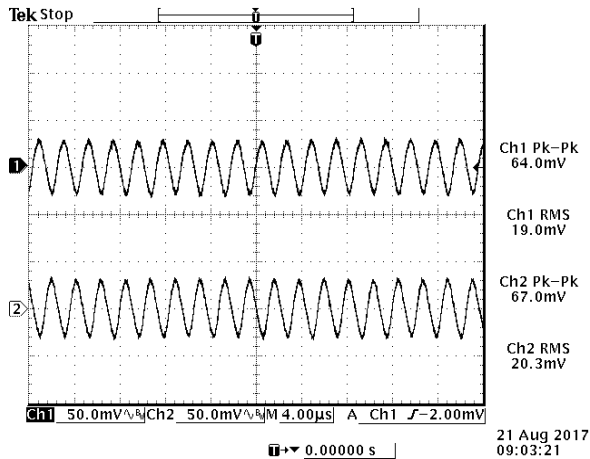

Figure 13.

**NOTE:** Ripple and noise at full load,  $V_{in}=11V$ ,  $V_o=2.5V$ , 0-20MHz BW, with 3\*100uF ceramic and 2\*220uF polymer capacitors at the output,  $T_a=25^\circ C$ .

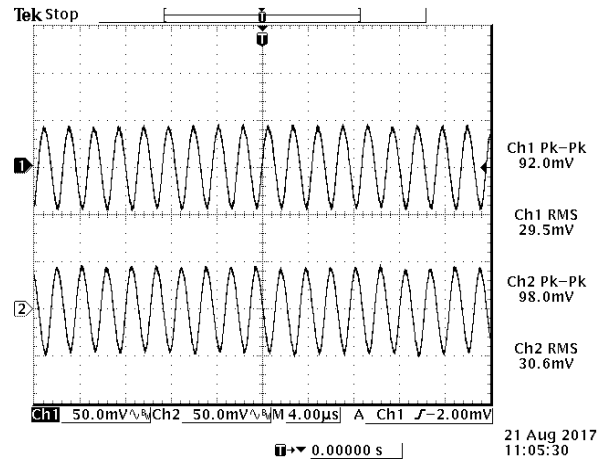

Figure 14.

**NOTE:** Ripple and noise at full load,  $V_{in}=11V$ ,  $V_o=3.3V$ , 0-20MHz BW, with 3\*100uF ceramic and 2\*220uF polymer capacitors at the output,  $T_a=25^\circ C$ .

## 10. TRANSIENT RESPONSE

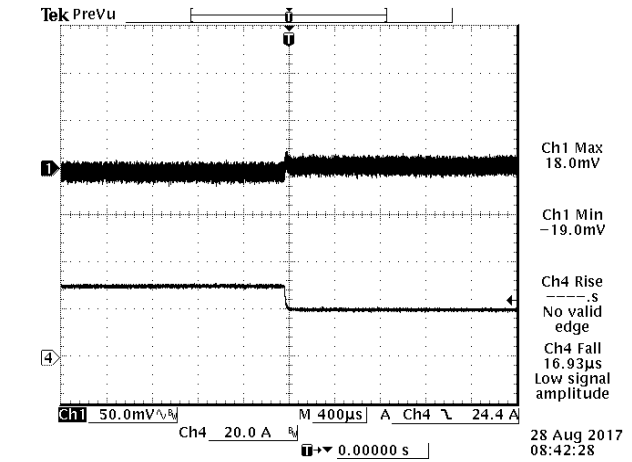
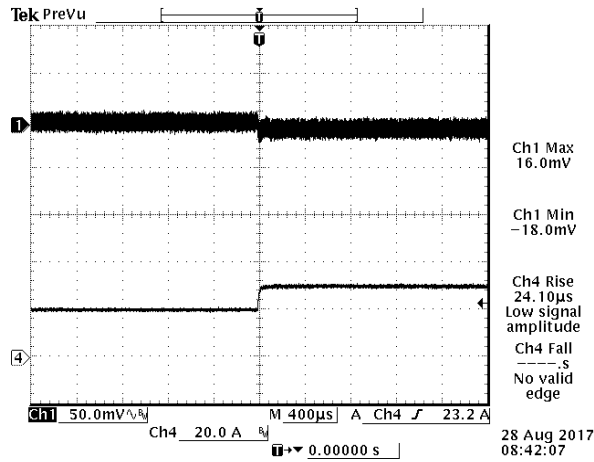

Figure 15.  $V_{in}=11V$ ,  $V_o=1.0V$ ,  $I_o=50\%-75\%I_o \text{ max}$ ,  $di/dt=1A/us$

Figure 16.  $V_{in}=11V$ ,  $V_o=1.0V$ ,  $I_o=75\%-50\%I_o \text{ max}$ ,  $di/dt=1A/us$

**NOTE:** 0-20MHz BW, with 3\*100uF ceramic and 2\*220uF polymer capacitors at the output,  $T_a=25^\circ C$ .

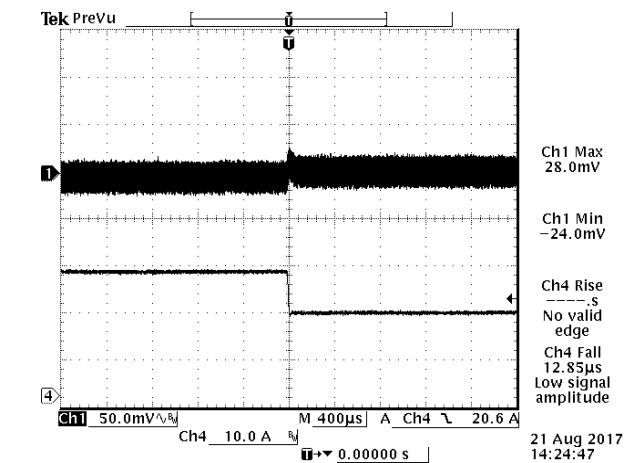
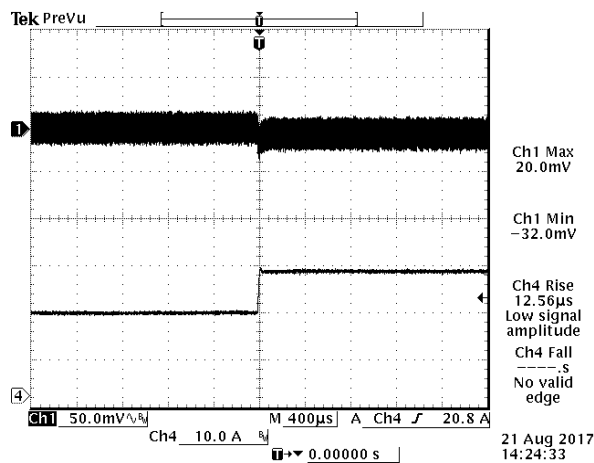

Figure 17.  $V_{in}=11V$ ,  $V_o=1.8V$ ,  $I_o=50\%-75\%I_o \text{ max}$ ,  $di/dt=1A/us$

Figure 18.  $V_{in}=11V$ ,  $V_o=1.8V$ ,  $I_o=75\%-50\%I_o \text{ max}$ ,  $di/dt=1A/us$

**NOTE:** 0-20MHz BW, with 3\*100uF ceramic and 2\*220uF polymer capacitors at the output,  $T_a=25^\circ C$

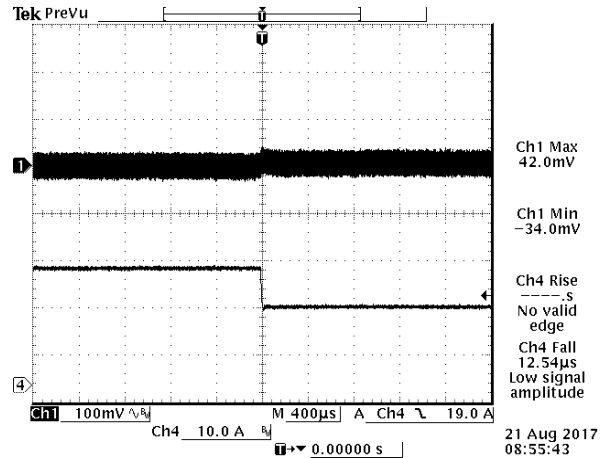
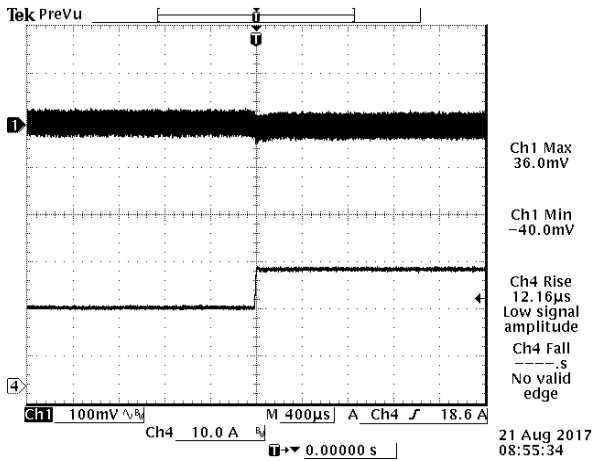

Figure 19.  $V_{in}=11V$ ,  $V_o=2.5V$ ,  $I_o=50\%-75\%I_{o\ max}$ ,  $di/dt=1A/us$

Figure 20.  $V_{in}=11V$ ,  $V_o=2.5V$ ,  $I_o=75\%-50\%I_{o\ max}$ ,  $di/dt=1A/us$

**NOTE:** 0-20MHz BW, with 3\*100uF ceramic and 2\*220uF polymer capacitors at the output,  $T_a=25\ ^\circ C$ .

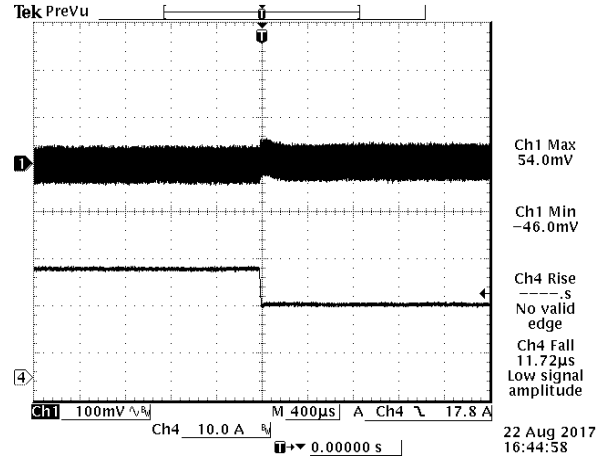
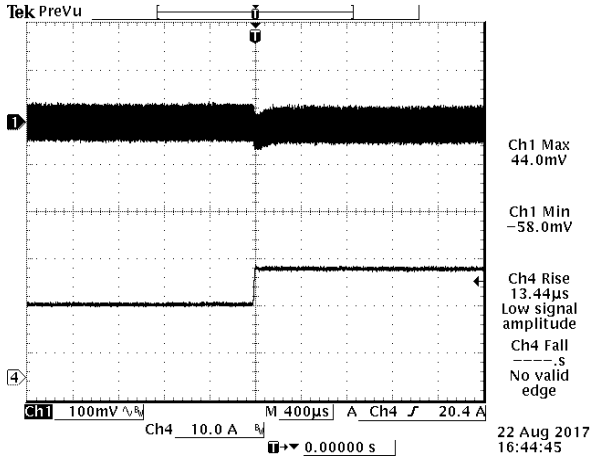

Figure 21.  $V_{in}=11V$ ,  $V_o=3.3V$ ,  $I_o=50\%-75\%I_{o\ max}$ ,  $di/dt=1A/us$

Figure 22.  $V_{in}=11V$ ,  $V_o=3.3V$ ,  $I_o=75\%-50\%I_{o\ max}$ ,  $di/dt=1A/us$

**NOTE:** 0-20MHz BW, with 3\*100uF ceramic and 2\*220uF polymer capacitors at the output,  $T_a=25\ ^\circ C$ .

## 11. OVER TEMPERATURE PROTECTION

Once the module has been disabled due to over temperature fault, the unit will auto recovery once temperature is below  $OT\_WARN\_LIMIT + 110^\circ C$ .

The OTP limit, hysteresis and response are configured using the Power Management bus commands  $OT\_FAULT\_LIMIT$ ,  $OT\_WARN\_LIMIT$  and  $OT\_FAULT\_RESPONSE$ .

## 12. OVER CURRENT PROTECTION

Hiccup: To provide protection in output overload condition, the module is equipped with internal current-limiting circuitry which can endure current limiting for a few milliseconds. If the overcurrent condition persists beyond a few milliseconds, the module will shut down then goes into hiccup mode and restart every 280 ms. The module operates normally when the output current goes into specified range. The typical average output current is 4 A during hiccup.

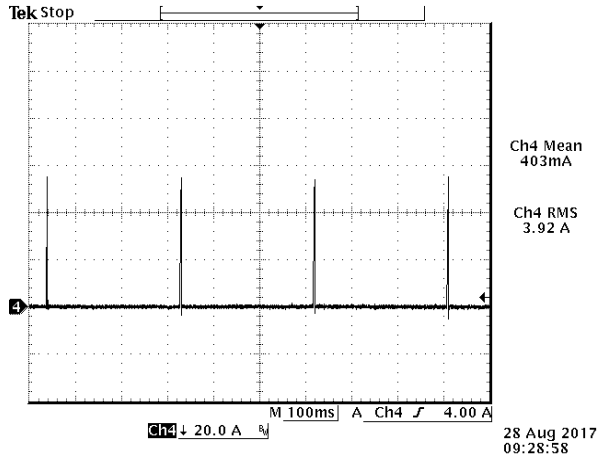

Figure 23. Vout1,  
Output current @ SCP,  $V_{in} = 11V$ ,  $V_{out} = 1.0V$ ,  $T_a = 25^\circ C$

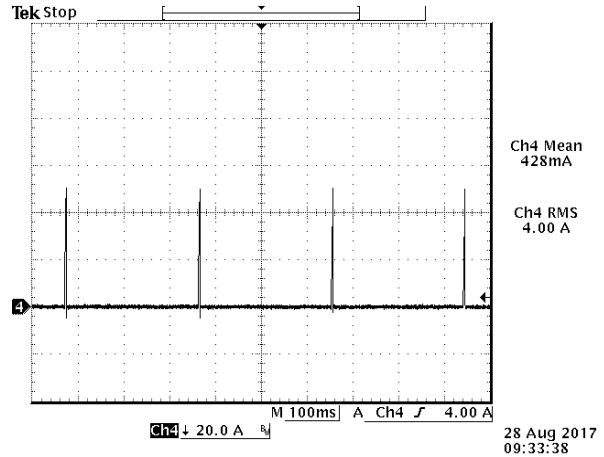

Figure 24. Vout2  
Output current @ SCP,  $V_{in} = 11V$ ,  $V_{out} = 1.0V$ ,  $T_a = 25^\circ C$

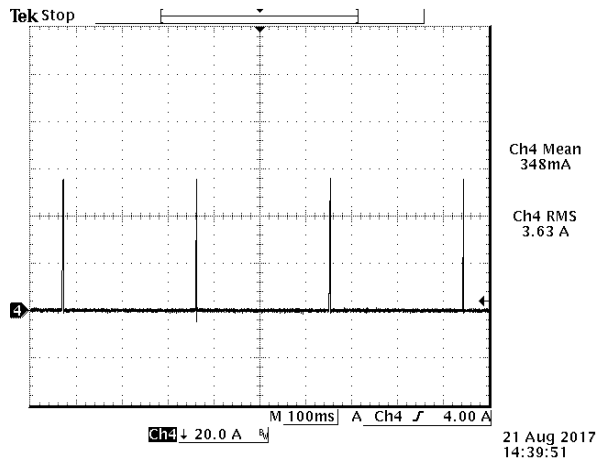

Figure 25. Vout1  
Output current @ SCP,  $V_{in} = 11V$ ,  $V_{out} = 1.8V$ ,  $T_a = 25^\circ C$

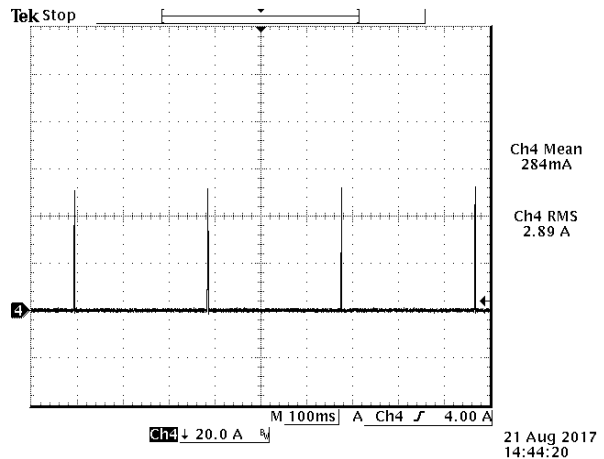

Figure 26. Vout2  
Output current @ SCP,  $V_{in} = 11V$ ,  $V_{out} = 1.8V$ ,  $T_a = 25^\circ C$

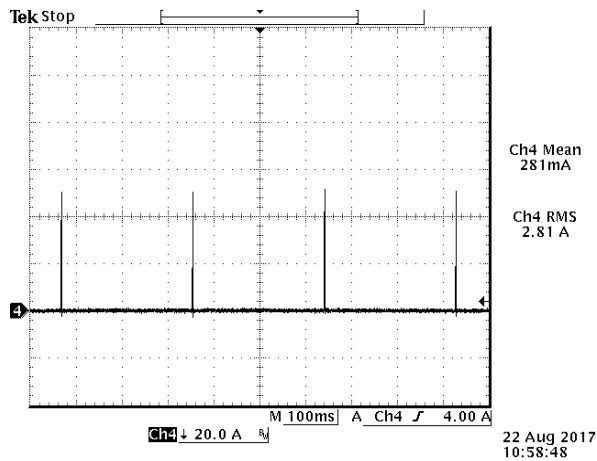

Figure 27. Vout1  
Output current @ SCP,  $V_{in} = 11V$ ,  $V_{out} = 2.5V$ ,  $T_a = 25^\circ C$

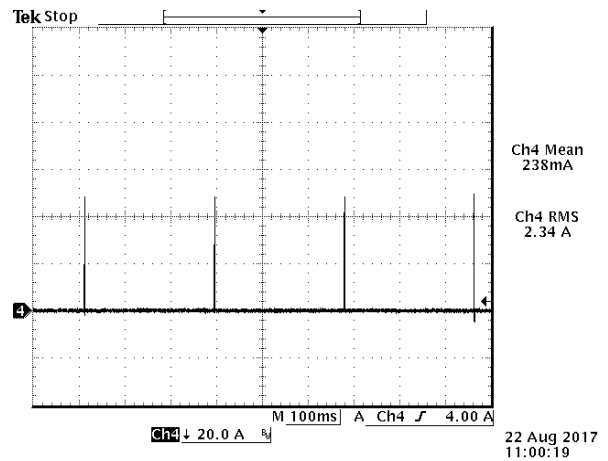

Figure 28. Vout2  
Output current @ SCP,  $V_{in} = 11V$ ,  $V_{out} = 2.5V$ ,  $T_a = 25^\circ C$

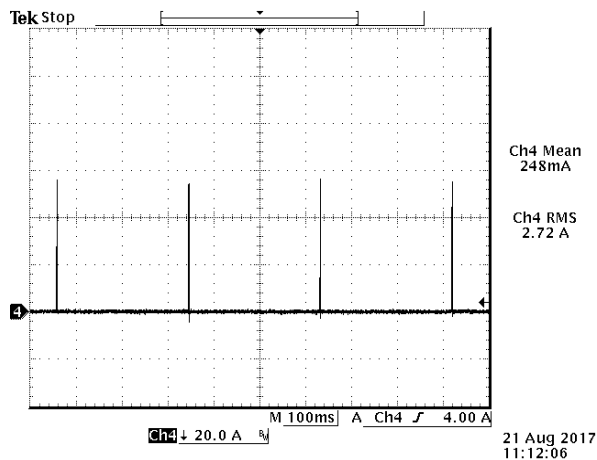

Figure 29. Vout1,  
Output current @ SCP,  $V_{in} = 11V$ ,  $V_{out} = 3.3V$ ,  $T_a = 25^\circ C$

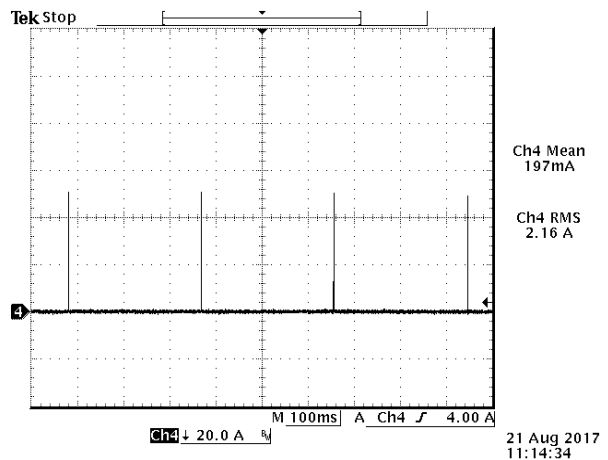

Figure 30. Vout2,  
Output current @ SCP,  $V_{in} = 11V$ ,  $V_{out} = 3.3V$ ,  $T_a = 25^\circ C$

### 13. INPUT UNDER-VOLTAGE LOCKOUT

The input undervoltage lockout (UVLO) prevents the module from operating when the input falls below a preset threshold. The default UVLO value is 6.7V. The input voltage undervoltage lock-out threshold can be set between 2.85V and 16V using the VIN\_UV\_FAULT\_LIMIT command.

The default response from an undervoltage fault is shut down and stay off until the fault has cleared, and the module has been disabled and re-enabled.

When controlling the module exclusively through the Power Management bus, a high voltage setting for UVLO can be used to prevent the module from being enabled until a lower voltage for UVLO is set using the VIN\_UV\_FAULT\_LIMIT command.

14. STARTUP & SHUTDOWN

Rise time

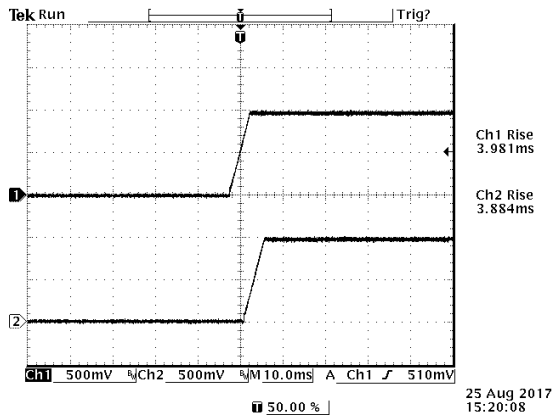

Figure 31. Test Condition:  $V_{out1} = 1.0V/40A$ ;  $V_{out2} = 1.0V/40A$  at  $V_{in} = 11V$  @  $T_a = 25^\circ C$

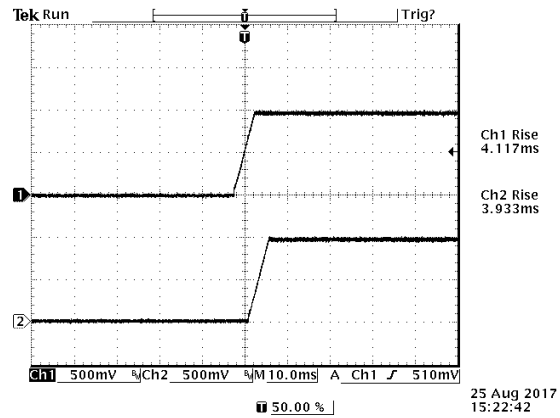

Figure 32. Test Condition:  $V_{out1} = 1.0V/40A$ ;  $V_{out2} = 1.0V/40A$  at  $V_{in} = 11V$  @  $T_a = 25^\circ C$   $C_{ext} = 3300\mu F$

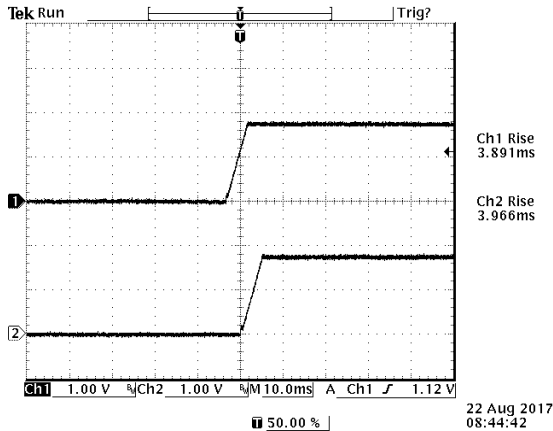

Figure 33. Test Condition:  $V_{out1} = 1.8V/35A$ ;  $V_{out2} = 1.8V/35A$  at  $V_{in} = 11V$  @  $T_a = 25^\circ C$

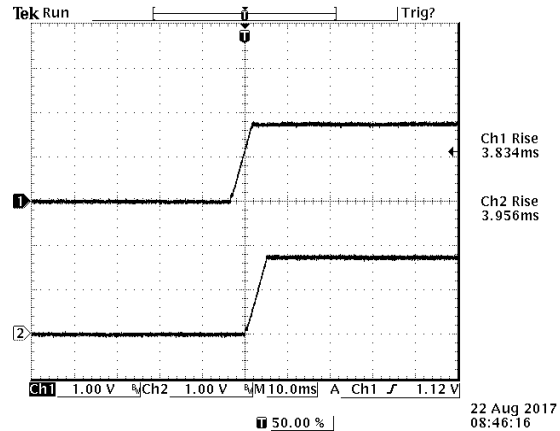

Figure 34. Test Condition:  $V_{out1} = 1.8V/35A$ ;  $V_{out2} = 1.8V/35A$  at  $V_{in} = 11V$  @  $T_a = 25^\circ C$   $C_{ext} = 3300\mu F$

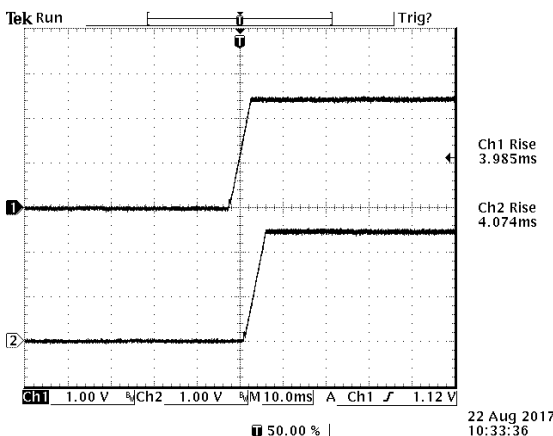

Figure 35. Test Condition:  $V_{out1} = 2.5V/32.5A$ ;  $V_{out2} = 2.5V/32.5A$  at  $V_{in} = 11V$  @  $T_a = 25^\circ C$

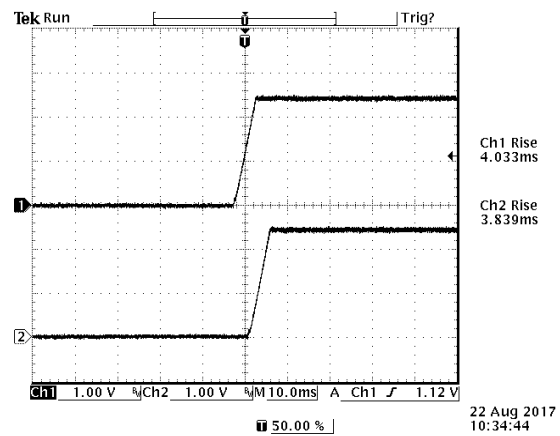

Figure 36. Test Condition:  $V_{out1} = 12.5V/32.5A$ ;  $V_{out2} = 2.5V/32.5A$  at  $V_{in} = 11V$  @  $T_a = 25^\circ C$   $C_{ext} = 3300\mu F$



Asia-Pacific  
+86 755 298 85888

Europe, Middle East  
+353 61 225 977

North America  
+1 408 785 5200

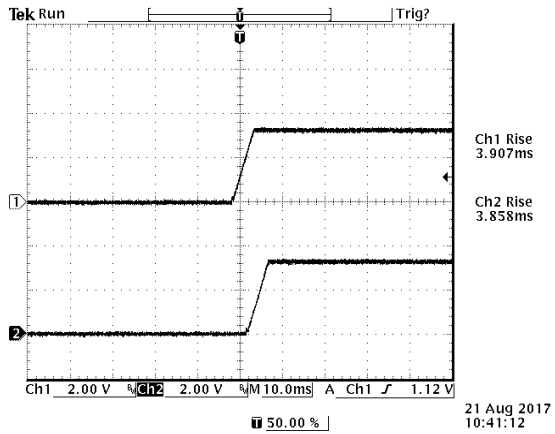

Figure 37. Test Condition:  $V_{out1} = 3.3V/30A$ ;  $V_{out2} = 3.3V/30A$  at  $V_{in} = 11V @ T_a = 25^\circ C$

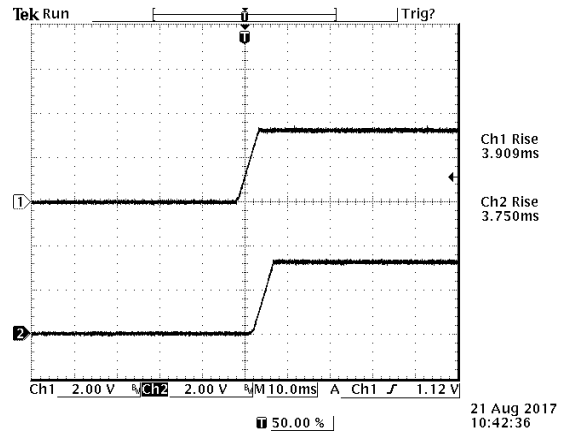

Figure 38. Test Condition:  $V_{out1} = 3.3V/30A$ ;  $V_{out2} = 3.3V/30A$  at  $V_{in} = 11V @ T_a = 25^\circ C$   $C_{ext} = 3300\mu F$

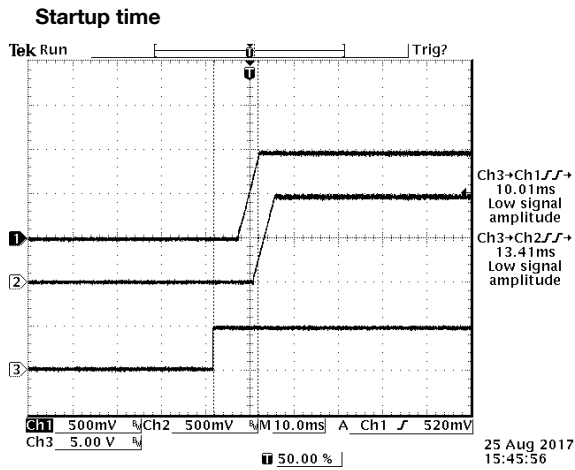

Figure 39. Startup from EN  
 Ch1:  $V_{out1}$ ; Ch2:  $V_{out2}$ ; Ch3: EN (EN1&EN2)  
 Test Condition:  $V_{out1} = 1.0V/40A$ ;  $V_{out2} = 1.0V/40A$  at  $V_{in} = 11V @ T_a = 25^\circ C$

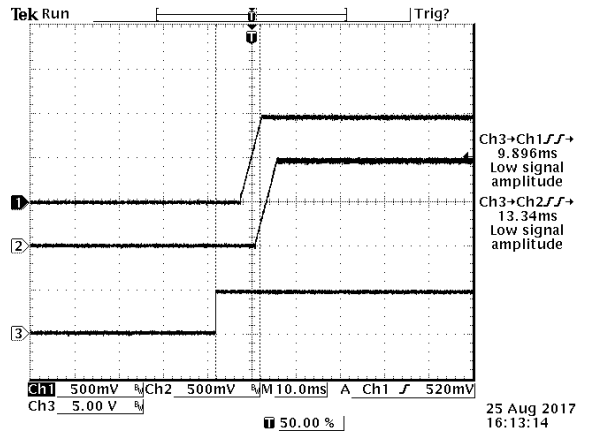

Figure 40. Startup from EN  
 Ch1:  $V_{out1}$ ; Ch2:  $V_{out2}$ ; Ch3: EN (EN1&EN2)  
 Test Condition:  $V_{out1} = 1.0V/40A$ ;  $V_{out2} = 1.0V/40A$  at  $V_{in} = 11V @ T_a = 25^\circ C$   $C_{ext} = 3300\mu F$



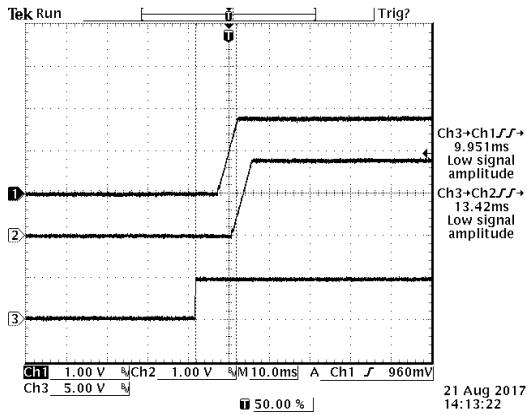

Figure 41. Startup from EN  
 Ch1: Vout1 ; Ch2: Vout2; Ch3: EN (EN1&EN2)  
 Test Condition: Vout1= 1.8V/35A; Vout2= 1.8V/35A at  
 Vin=11V@Ta=25°C

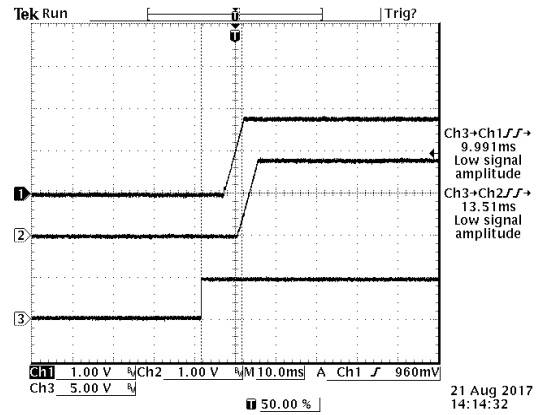

Figure 42. Startup from EN  
 Ch1: Vout1 ; Ch2: Vout2; Ch3: EN (EN1&EN2)  
 Test Condition: Vout1= 1.8V/35A; Vout2= 1.8V/35A at  
 Vin=11V@Ta=25°C Cext = 3300uF

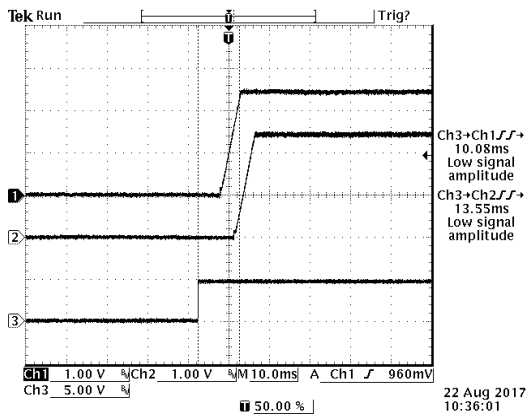

Figure 43. Startup from EN  
 Ch1: Vout1 ; Ch2: Vout2; Ch3: EN (EN1&EN2)  
 Test Condition: Vout1= 2.5V/32.5A; Vout2= 2.5V/32.5A  
 Vout2= 2.5V/32.5A at Vin=11V@Ta=25°C

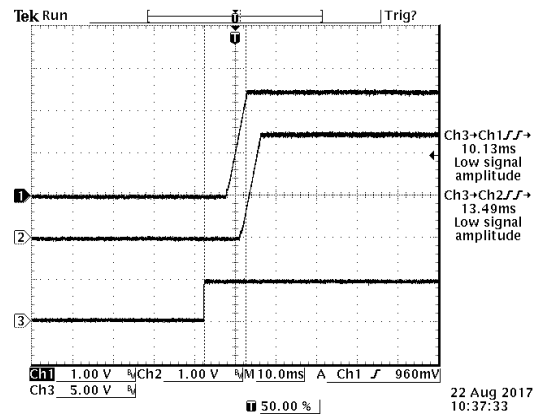

Figure 44.. Startup from EN  
 Ch1: Vout1 ; Ch2: Vout2; Ch3: EN (EN1&EN2)  
 Test Condition: Vout1= 2.5V/32.5A;  
 at Vin=11V@Ta=25°C Cext = 3300uF

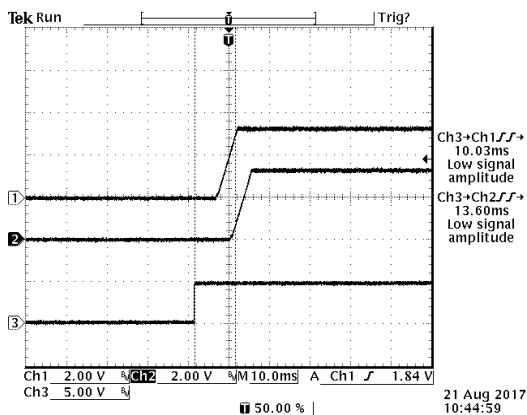

Figure 45. Startup from EN  
 Ch1: Vout1 ; Ch2: Vout2; Ch3: EN (EN1&EN2)  
 Test Condition: Vout1= 3.3V/30A; Vout2= 3.3V/30A at  
 Vin=11V@Ta=25°C

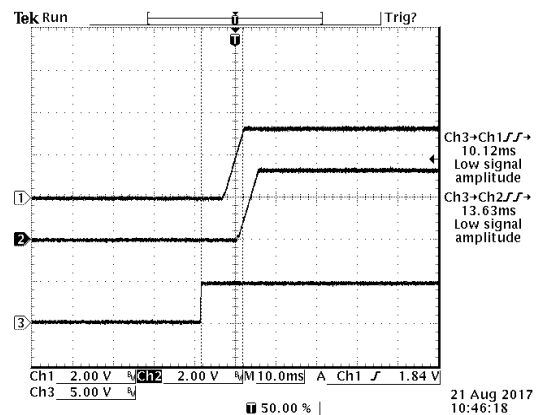

Figure 46.Startup from EN  
 Ch1: Vout1 ; Ch2: Vout2; Ch3: EN (EN1&EN2)  
 Test Condition: Vout1= 3.3V/30A; Vout2= 3.3V/30A at  
 Vin=11V@Ta=25°C Cext = 3300uF



Shutdown

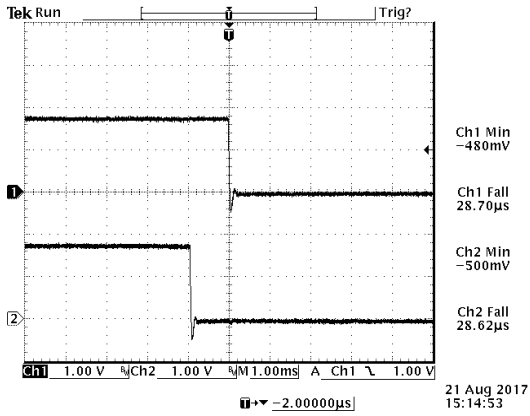

Figure 47. Ch1: Vout1 ; Ch2: Vout2  
Test Condition: Vout1= 1.0V/40A; Vout2= 1.0V/40A at Vin=11V@Ta=25°C

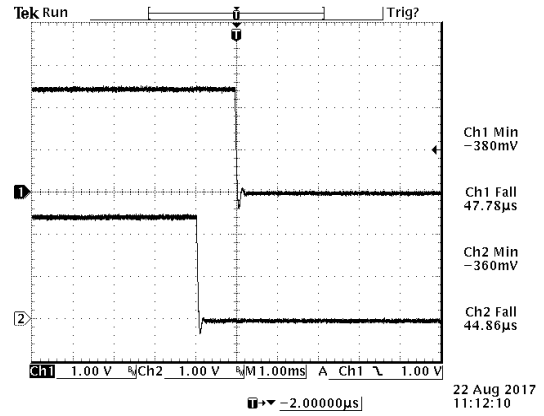

Figure 48. Ch1: Vout1 ; Ch2: Vout2  
Test Condition: Vout1= 1.8V/35A; Vout2= 1.8V/35A at Vin=11V@Ta=25°C

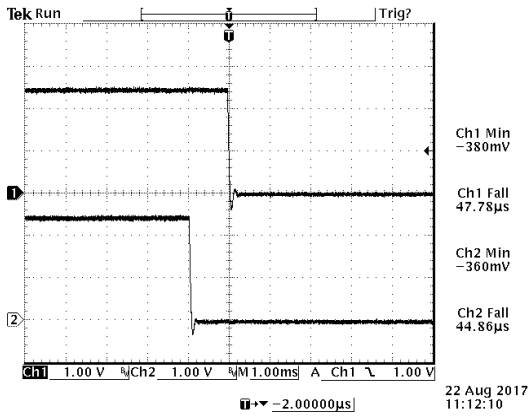

Figure 49. Ch1: Vout1 ; Ch2: Vout2  
Test Condition: Vout1= 2.5V/32.5A; Vout2= 2.5V/32.5A at Vin=11V@Ta=25°C

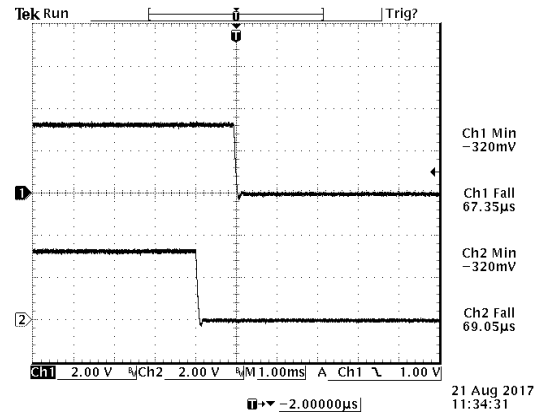

Figure 50. Ch1: Vout1 ; Ch2: Vout2  
Test Condition: Vout1= 3.3V/30A; Vout2= 3.3V/30A at Vin=11V@Ta=25°C

## 15. POWER GOOD

The module provides power good (PG1, PG2) for each output that indicates the output voltage is within a specified tolerance of its target level and no-fault condition exists. By default, the PG pin will assert if the output is within 10% of the target voltage. These limits and the polarity of the pin may be changed using power management bus commands.

A PG delay period is defined as the time from when all conditions within the module for asserting PG are met to when the PG pin is asserted. This feature is commonly used instead of using an external reset controller to control external digital logic. By default, the module PG delay is set equal to 1ms. The PG delay may be set using a Power Management bus command as described in “POWER\_GOOD\_DELAY (D4h)”.

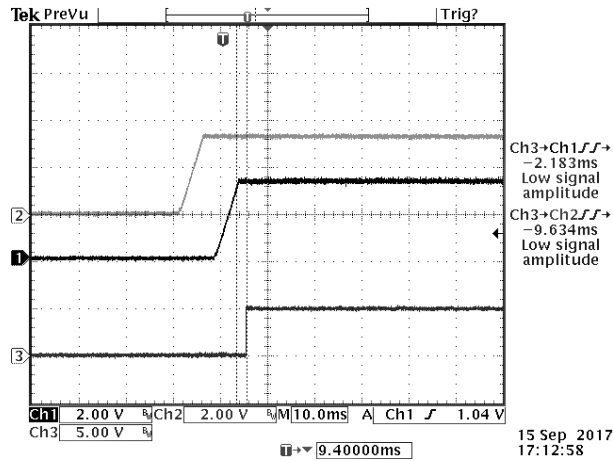

Figure 51.  
Ch1: Vout1 ; Ch2: Vout2; Ch3: PG (PG1&PG2)



## Block Diagram - 4 Phases in Single Output Mode

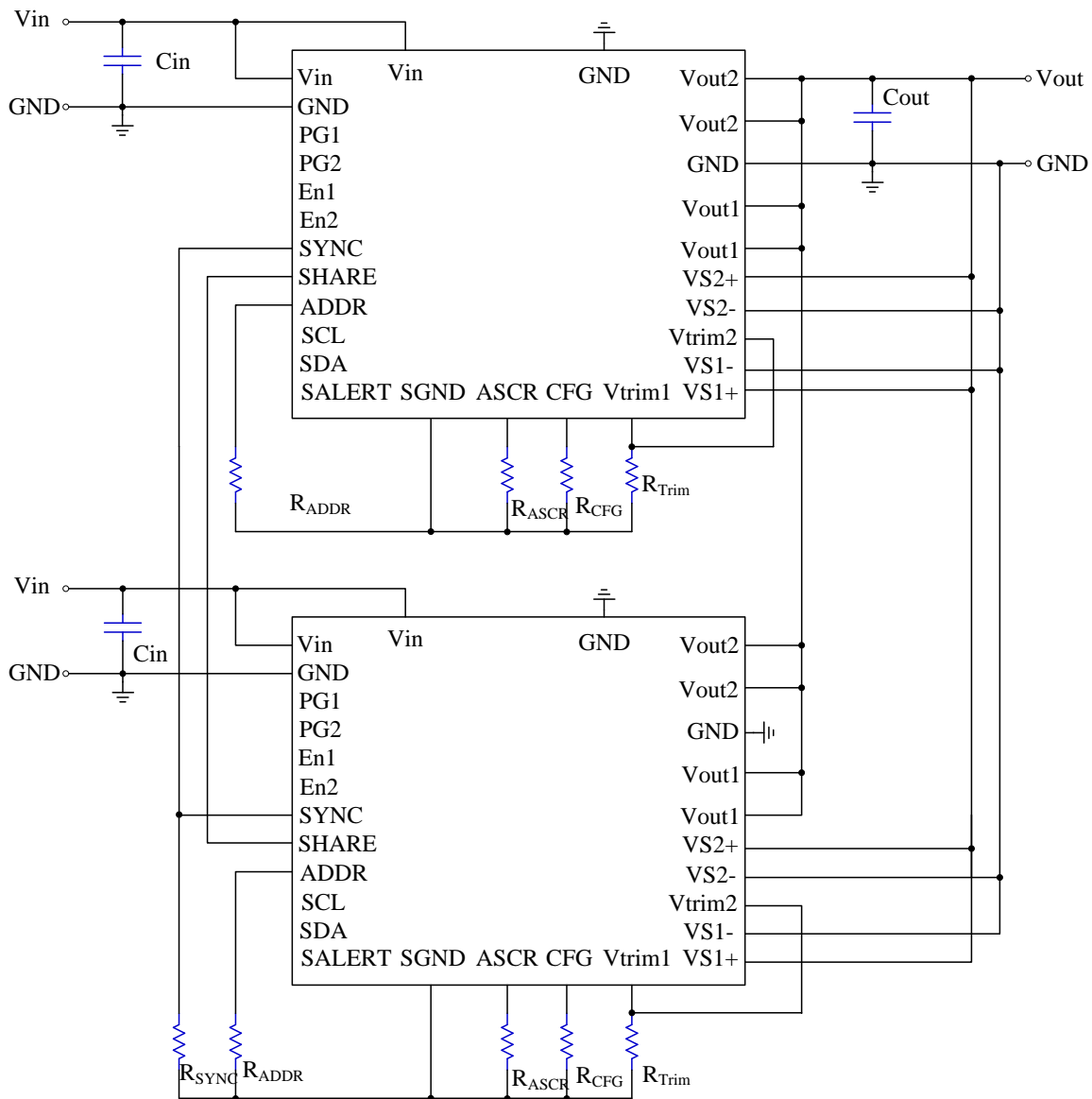

Figure 54.

## 17. TRIM/OUTPUT VOLTAGE ADJUSTMENT

The output voltage is adjustable from 0.6V to 5.0 V. The outputs can be adjusted with an external resistor placed between the “Vtrim1 or Vtrim2” and “GND”. Vo1 and Vo2 can also be set by Power Management bus command. VOUT\_MAX is also determined by this pin-strap setting, and is 15% greater than the Vtrim0 and Vtrim1 voltage settings by default, however VOUT\_MAX can be changed via the Power Management bus.

### Trim Resistor

RTrim (kΩ)	VOUT (V)	RTrim (kΩ)	VOUT (V)
LOW	1	38.3	1.3
OPEN	1.2	42.2	1.4
HIGH	0.9	46.4	1.5
10	0.6	51.1	1.6
11	0.65	56.2	1.7
12.1	0.7	61.9	1.8
13.3	0.75	68.1	1.9
14.7	0.8	75	2
16.2	0.85	82.5	2.1
17.8	0.9	90.9	2.2
19.6	0.95	100	2.3
21.5	1	110	2.5
23.7	1.05	121	2.8
26.1	1.1	133	3
28.7	1.15	147	3.3
31.6	1.2	162	4
34.8	1.25	178	5

## 18. CHARGE MODE CONTROL SETTING (ASCR)

The device's Charge-Mode response can be optimized by adjusting the ASCR gain and residual settings, either by resistor between ASCR and GND, or by using the ASCR\_CONFIG Power Management Bus command.

### Charge Mode Setting Resistor (RASCR)

RASCR(kΩ)	Vo1 GAIN	Vo2 GAIN	RASCR(kΩ)	Vo1 GAIN	Vo2 GAIN
10	200	200	51.1	800	600
11	200	400	56.2	800	800
12.1	200	600	61.9	800	1000
13.3	200	800	68.1	1000	200
14.7	200	1000	75	1000	400
16.2	400	200	82.5	1000	600
17.8	400	400	90.9	1000	800
19.6	400	600	100	1000	1000
21.5	400	800	110	100	100
23.7	400	1000	121	300	300
26.1	600	200	133	500	500
28.7	600	400	147	700	700
31.6	600	600	162	900	900
34.8	600	800	178	1100	1100
38.3	600	1000	LOW	300	300
42.2	800	200	OPEN	500	500
46.4	800	400	HIGH	700	700

## 19. CONFIGURATION SETTING (CFG)

The Configuration pin (CFG) sets several module configuration settings allowing the module to be used in applications without the need for loading configuration files. When using the module in a 4-phase application, the master module address must be 1 higher than the slave address. This must be done in order for the 2 modules to be recognized as part of a current sharing group. See Power Management bus command “DDC\_CONFIG (D3h)” for details.

### Configuration Setting Resistor (RCFG)

RCFG(kΩ)	Vo1 AVERAGE OC LIMIT (A)	Vo1 PEAK OC LIMIT (A)	Vo2 AVERAGE OC LIMIT (A)	Vo2 PEAK OC LIMIT (A)	MODE
10	25	28	25	28	2 Outputs
11	35	40	35	40	2 Outputs
12.1	45	50	45	50	2 Outputs
13.3	55	60	55	60	2 Outputs
17.8	35	40	25	28	2 Outputs
19.6	45	50	25	28	2 Outputs
21.5	55	60	25	28	2 Outputs
23.7	45	50	35	40	2 Outputs
26.1	55	60	35	40	2 Outputs
28.7	55	60	45	50	2 Outputs
31.6	25	28	35	40	2 Outputs
34.8	25	28	45	50	2 Outputs
38.3	25	28	55	60	2 Outputs
42.2	35	40	45	50	2 Outputs
46.4	35	40	55	60	2 Outputs
51.1	45	50	55	60	2 Outputs
56.2	25	28	25	28	2-Phase
61.9	35	40	35	40	2-Phase
68.1	45	50	45	50	2-Phase
75	55	60	55	60	2-Phase
90.9	35	40	35	40	4-PH Master
100	35	40	35	40	4-PH Slave
110	45	50	45	50	4-PH Master
121	45	50	45	50	4-PH Slave
133	55	60	55	60	4-PH Master
147	55	60	55	60	4-PH Slave
162	65	70	65	70	4-PH Master
178	65	70	65	70	4-PH Slave
LOW	20	22.5	20	22.5	2-Phase
OPEN	20	22.5	20	22.5	2 Output
HIGH	35	40	35	40	2 Output

## 20. SWITCHING FREQUENCY SETTING (SYNC)

The module switching frequency can be set from 400kHz to 800kHz by connect a RSYNC to SGND or using the Power Management bus command REQUENCY\_SWITCH. Switching frequency of 457kHz is recommended.

The module can be driven by an external clock source connected to the SYNC pin. When using the internal oscillator, the SYNC pin can be configured as a clock source. By default, the SYNC pin is configured as an input. The module will automatically check for a clock signal on the SYNC pin each time ON/OFF is asserted. The module will then synchronize with the rising edge of the external clock.

The incoming clock signal must be in the range of 400kHz to 800kHz and must be stable when the ON/OFF pin (ON/OFF0, ON/OFF1) is asserted. When using an external clock, the frequencies are not limited to discrete values as when using the internal clock. The external clock signal must not vary more than 10% from its initial value, and should have a minimum pulse width of 150ns. In the event of a loss of the external clock signal, the output voltage may show transient over shoot or undershoot. If loss of synchronization occurs, the module will automatically switch to its internal oscillator and switch at its programmed frequency.

The SYNC pin can also be configured as an output. The module will run from its internal oscillator and will drive the SYNC pin so other modules can be synchronized to it. The SYNC pin will not be checked for an incoming clock signal while in this mode. The switching frequency can be set to any value between 400kHz to 800kHz using a Power Management bus command. The available frequencies below 800kHz are defined by  $f_{SW} = 16\text{MHz}/N$ , where  $20 \leq N \leq 40$ .

If a value other than  $f_{SW} = 16\text{MHz}/N$  is entered using a Power Management bus command, the internal circuitry will select the switching frequency value using N as a whole number to achieve a value close to the entered value. For example, if 810kHz is entered, the module will select 800kHz ( $N=20$ ).

### Resistor for switching frequency setting

RSYNC(k $\Omega$ )	FREQ(kHz)	RSYNC(k $\Omega$ )	FREQ(kHz)
OPEN	400	28.7	571
HIGH	485	31.6	615
21.5	432	34.8	727
23.7	457	38.3	800
26.1	533		

## 21. CURRENT SHARING (SHARE)

By connecting the SHARE and SYNC pins of each module and configuring the modules as a current sharing rail, the modules will share the current equally. Current sensing element tolerances should be taken into account, or adjusted for using the IOUT\_CAL\_GAIN and IOUT\_CAL\_OFFSET commands when necessary. Up to 4 modules can be configured in a given current sharing group.



## 22. POWER MANAGEMENT BUS ADDRESS SELECTION (SA)

When communicating with multiple Power Management bus modules using the Power Management bus interface, each module must have its own unique address so the host can distinguish between the module. The module address can be set by a resistor from pin ADDR to SGND. When operating in 2-channel mode, care must be taken when using sequential Power Management bus addresses. Since DDC(SHARE) addresses are automatically set using the Power Management bus address, it is possible for a module with a Power Management bus address immediately after a 2-channel module to be automatically configured with the same DDC address as one of the module channels, which could cause unintended operating modes. For this reason, do not use the next higher Power Management bus address when using the module as a 2-channel module. See Power Management bus command “DDC\_CONFIG (D3h)” for details. The Power Management bus address cannot be changed with a Power Management bus command.

### Power Management Bus Address (RADDR)

RADDR(kΩ)	POWER MANAGEMENT BUS ADDRESS	RADDR (kΩ)	POWER MANAGEMENT BUS ADDRESS
LOW	40h	42.2	51h
OPEN	42h	46.4	52h
10	41h	51.1	53h
11	43h	56.2	54h
12.1	44h	61.9	55h
13.3	45h	68.1	56h
14.7	46h	75	57h
16.2	47h	82.5	58h
17.8	48h	90.9	59h
19.6	49h	100	5Ah
21.5	4Ah	110	5Bh
23.7	61h	121	5Ch
26.1	4Ch	133	5Dh
28.7	4Dh	147	5Eh
31.6	4Eh	162	5Fh
34.8	4Fh	178	60h

## 23. POWER MANAGEMENT BUS COMMAND SUMMARY

CODE	COMMAND NAME	DESCRIPTION	TYPE	DATA FORMAT	DEFAULT VALUE	DEFAULT SETTING
00h	PAGE	Selects Controller 0, 1, or both	R/W	BIT	00h	Page 0 Controller addressed
01h	OPERATION	Enable/disable, margin settings	R/W	BIT	00h	Immediate off, nominal margin
02h	ON_OFF_CONFIG	On/off configuration settings	R/W	BIT	17h	ENABLE pin control, active high
03h	CLEAR_FAULTS	Clears faults	Write	N/A	N/A	N/A
11h	STORE_DEFAULT_ALL	Stores values to default store	Write	N/A	N/A	N/A
12h	RESTORE_DEFAULT_ALL	Restores values from default store	Write	N/A	N/A	N/A
15h	STORE_USER_ALL	Stores values to user store	Write	N/A	N/A	N/A
16h	RESTORE_USER_ALL	Restores values from user store	Write	N/A	N/A	N/A
20h	VOUT_MODE	Reports VOOUT mode and exponent	Read	BIT	13h	Linear mode, exponent = -13
21h	VOUT_COMMAND	Sets nominal VOOUT set-point	R/W	L16u	N/A	Pin-strap setting
22h	VOUT_TRIM	Applies offset voltage to VOOUT set-point	R/W	L16s	0000h	0V
23h	VOUT_CAL_OFFSET	Applies offset voltage to VOOUT set-point	R/W	L16s	0000h	0V
24h	VOUT_MAX	Sets maximum VOOUT set-point	R/W	L16u	N/A	1.15 x VSET pin-strap setting
25h	VOUT_MARGIN_HIGH	Sets VOOUT set-point during margin high	R/W	L16u	N/A	1.05 x VSET pin-strap setting
26h	VOUT_MARGIN_LOW	Sets VOOUT set-point during margin low	R/W	L16u	N/A	0.95 x VSET pin-strap setting
27h	VOUT_TRANSITION_RATE	Sets VOOUT transition rate during margin commands	R/W	L11	BA00h	1V/ms
28h	VOUT_DROOP	Sets V/I slope for total rail output current (all phases combined)	R/W	L11	N/A	CFG pin-strap setting
33h	FREQUENCY_SWITCH	Sets switching frequency	R/W	L11	N/A	SYNC pin-strap setting
37h	INTERLEAVE	Configures phase offset during group operation	R/W	BIT	N/A	CFG pin-strap setting
38h	IOUT_CAL_GAIN	Sets impedance of current sense circuit	R/W	L11	B3CCh	0.95mV/A,
39h	IOUT_CAL_OFFSET	Sets an offset to IOUT sense circuit	R/W	L11	BD00h	-1.5A
40h	VOOUT_OV_FAULT_LIMIT	Sets the VOOUT overvoltage fault threshold	R/W	L16u	N/A	1.10 x VSET pin-strap setting
41h	VOOUT_OV_FAULT_RESPONSE	Sets the VOOUT overvoltage fault response	R/W	BIT	80h	Disable, no retry
44h	VOOUT_UV_FAULT_LIMIT	Sets the VOOUT undervoltage fault threshold	R/W	L16u	N/A	0.85 x VSET pin-strap setting
45h	VOOUT_UV_FAULT_RESPONSE	Sets the VOOUT undervoltage fault response	R/W	BIT	80h	Disable, no retry
46h	IOUT_OC_FAULT_LIMIT	Sets the IOUT peak overcurrent fault threshold for each phase	R/W	L11	N/A	CFG pin-strap setting
4Bh	IOUT_UC_FAULT_LIMIT	Sets the IOUT valley undercurrent fault threshold for each phase	R/W	L11	N/A	1*IOUT_OC_FAULT_LIMIT from CFG pin-strap setting
4Fh	OT_FAULT_LIMIT	Sets the over-temperature fault limit	R/W	L11	EBE8h	+125°C
50h	OT_FAULT_RESPONSE	Sets the over-temperature fault response	R/W	BIT	FFh	Continuous retry, 280ms retry delay
51h	OT_WARN_LIMIT	Sets the over-temperature warning limit	R/W	L11	EB70h	+110°C
52h	UT_WARN_LIMIT	Sets the under-temperature warning limit	R/W	L11	E580h	-40°C
53h	UT_FAULT_LIMIT	Sets the under-temperature fault limit	R/W	L11	E440h	-60°C
54h	UT_FAULT_RESPONSE	Sets the under-temperature fault response	R/W	BIT	FFh	Continuous retry, 280ms retry delay
55h	VIN_OV_FAULT_LIMIT	Sets the VIN overvoltage fault threshold	R/W	L11	D3C0h	15V

56h	VIN_OV_FAULT_RESPONSE	Sets the VIN overvoltage fault response	R/W	BIT	80h	Disable, no retry
57h	VIN_OV_WARN_LIMIT	Sets the VIN overvoltage warning threshold	R/W	L11	D360h	13.5V
58h	VIN_UV_WARN_LIMIT	Sets the VIN undervoltage warning threshold	R/W	L11	N/A	1.1 x UVLO pin-strap setting
59h	VIN_UV_FAULT_LIMIT	Sets the VIN undervoltage fault threshold	R/W	L11	N/A	UVLO pin-strap setting
5Ah	VIN_UV_FAULT_RESPONSE	Sets the VIN undervoltage fault response	R/W	BIT	BFh	Continuous retries, 280ms retry delay
5Eh	POWER_GOOD_ON	Sets the voltage threshold for power-good indication	R/W	L16u	N/A	0.9 x VSET pin-strap setting
60h	TON_DELAY	Sets the delay time from enable to VOUT rise	R/W	L11	CA80h	5ms
61h	TON_RISE	Sets the rise time of VOUT after ENABLE and TON_DELAY	R/W	L11	CA80h	5ms
64h	TOFF_DELAY	Sets the delay time from DISABLE to start of VOUT fall	R/W	L11	CA80h	5ms
65h	TOFF_FALL	Sets the fall time for VOUT after DISABLE and TOFF_DELAY	R/W	L11	CA80h	5ms
78h	STATUS_BYTE	First byte of STATUS_WORD	Read	BIT	00h	No faults
79h	STATUS_WORD	Summary of critical faults	Read	BIT	0000h	No faults
7Ah	STATUS_VOUT	Reports VOUT warnings/faults	Read	BIT	00h	No faults
7Bh	STATUS_IOUT	Reports IOUT warnings/faults	Read	BIT	00h	No faults
7Ch	STATUS_INPUT	Reports input warnings/faults	Read	BIT	00h	No faults
7Dh	STATUS_TEMP	Reports temperature warnings/faults	Read	BIT	00h	No faults
7Eh	STATUS_CML	Reports communication, memory, logic errors	Read	BIT	00h	No faults
80h	STATUS_MFR_SPECIFIC	Reports voltage monitoring/clock synchronization faults	Read	BIT	00h	no faults
88h	READ_VIN	Reports input voltage measurement	Read	L11	N/A	N/A
89h	READ_IIN	Reports input current measurement	Read	L11	N/A	N/A
8Bh	READ_VOUT	Reports output voltage measurement	Read	L16u	N/A	N/A
8Ch	READ_IOUT	Reports output current measurement	Read	L11	N/A	N/A
8Dh	READ_TEMPERATURE_1	Reports internal temperature measurement	Read	L11	N/A	N/A
8Eh	READ_TEMPERATURE_2	Reports external temperature measurement from XTEMP pins	Read	L11	N/A	N/A
8Fh	READ_TEMPERATURE_3	Reports external temperature measurement from VMON/TMON pin.	Read	L11	N/A	N/A
94h	READ_DUTY_CYCLE	Reports actual duty cycle	Read	L11	N/A	N/A
95h	READ_FREQUENCY	Reports actual switching frequency	Read	L11	N/A	N/A
98h	POWER MANAGEMENT BUS_REVISION	Reports the POWER MANAGEMENT BUS revision used	Read	BIT	22h	P1 R1.2, P2 R1.2
99h	MFR_ID	Sets a user defined identification	R/W	ASC	N/A	<null>
9Ah	MFR_MODEL	Sets a user defined model	R/W	ASC	N/A	<null>
9Bh	MFR_REVISION	Sets a user defined revision	R/W	ASC	N/A	<null>
9Ch	MFR_LOCATION	Sets a user defined location identifier	R/W	ASC	N/A	<null>
9Dh	MFR_DATE	Sets a user defined date	R/W	ASC	N/A	<null>
9Eh	MFR_SERIAL	Sets a user defined serialized identifier	R/W	ASC	N/A	<null>
ADh	IC_DEVICE_ID	Reports device identification information	Read	CUS	49A02D00h	Intersil MODULE
AEh	IC_DEVICE_REV	Reports device revision information	Read	CUS	01000000h	Initial Release
B0h	USER_DATA_00	Sets user defined data	R/W	ASC	N/A	<null>
CEh	MIN_VOUT_REG	Sets a minimum start-up voltage	R/W	L11	0000h	0mV
D0h	ISENSE_CONFIG	Configures current sensing circuitry	R/W	BIT	620Eh	Downslope, 5 fault count, 384ns blanking, high range
D1h	USER_CONFIG	Configures several user-level features	R/W	BIT	N/A	Set by CFG pin-strap setting
D2h	IIN_CAL_GAIN	Sets the resistance of the input current sensing resistor	R/W	L11	C200h	2mfi

D3h	DDC_CONFIG	Configures the DDC addressing and current sharing	R/W	BIT	N/A	Set by pin-strapped Power Management bus address and CFG pin-strap setting
D4h	POWER_GOOD_DELAY	Sets the delay between PG threshold and PG assertion	R/W	L11	BA00h	1ms
D5h	MULTI_PHASE_RAMP_GAIN	Adjusts the ramp-up and ramp-down rate by setting the feedback gain	R/W	CUS	03h	3
D6h	INDUCTOR	Sets the inductor value	R/W	L11	B133h	0.3μH
D7h	SNAPSHOT_FAULT_MASK	Masks faults that cause a snapshot to be taken	R/W	BIT	0000h	No faults masked
D8h	OVUV_CONFIG	Configures output voltage OV/UV fault detection	R/W	BIT	00h	Low side FET off on fault, 1 violation triggers fault.
D9h	XTEMP_SCALE	Calibrates external temperature sensor	R/W	L11	BA00h	1/degree C
DAh	XTEMP_OFFSET	Offset calibration for external temperature sensor	R/W	L11	0000h	No offset
DBh	MFR_SMBALERT_MASK	Identifies which fault limits will not assert SALRT	R/W	Custom	00..00h	N/A
DCh	TEMPCO_CONFIG	Sets tempco settings	R/W	BIT	00h	0ppm/°C
DDh	PINSTRAP_READ_STATUS	Reads pin-strap settings	Read	BIT	N/A	Set by pin-straps
DFh	ASCR_CONFIG	Configures the ASCR settings	R/W	BIT	N/A	ASCRCFG pin-strap setting
E0h	SEQUENCE	DDC rail sequencing configuration	R/W	BIT	00h	Prequel and sequel disabled
E1h	TRACK_CONFIG	Configures voltage tracking.	R/W	BIT	00h	Tracking disabled
E2h	DDC_GROUP	Configures group ID, fault spreading, OPERATION and VOUT	R/W	BIT	N/A	Set by CFG pin-strap
E4h	DEVICE_ID	Returns the device identifier string	Read	ASC	TBD	MODULE, current revisions
E5h	MFR_IOUT_OC_FAULT_RESPONSE	Configures the IOUT overcurrent fault response	R/W	BIT	BFh	Continuous retries, 280ms retry delay
E6h	MFR_IOUT_UC_FAULT_RESPONSE	Configures the IOUT undercurrent fault response	R/W	BIT	BFh	Continuous retries, 280ms retry delay
E7h	IOUT_AVG_OC_FAULT_LIMIT	Sets the IOUT average overcurrent fault threshold	R/W	L11	N/A	Set by CFG pin-strap
E8h	IOUT_AVG_UC_FAULT_LIMIT	Sets the IOUT average undercurrent fault threshold	R/W	L11	N/A	<sup>-1*</sup> IOUT_AVG_OC_FAULT_LIMIT
E9h	USER_GLOBAL_CONFIG	Sets options pertaining to advanced features	R/W	BIT	N/A	Set by CFG pin-strap setting
EAh	SNAPSHOT	32-byte read-back of parametric and status values	Read	BIT	N/A	<null>
F0h	LEGACY_FAULT_GROUP	Configures fault group compatibility with older Intersil digital power devices	R/W	BIT	00000000h	<null>
F3h	SNAPSHOT_CONTROL	Snapshot feature control command	R/W	BIT	00h	N/A
F4h	RESTORE_FACTORY	Restores device to the hard-coded default values	Write	N/A	N/A	N/A
F5h	MFR_VMON_OV_FAULT_LIMIT	Sets the VMON overvoltage fault threshold	R/W	L11	C266h	2.4V, SPS OT trip voltage
F6h	MFR_VMON_UV_FAULT_LIMIT	Sets the VMON undervoltage fault threshold	R/W	L11	A333h	0.2V
F7h	MFR_READ_VMON	Reads the VMON voltage	Read	L11	N/A	N/A
F8h	VMON_OV_FAULT_RESPONSE	Configures the VMON overvoltage fault response	R/W	BIT	BFh	Continuous retry
F9h	VMON_UV_FAULT_RESPONSE	Configures the VMON undervoltage fault response	R/W	BIT	BFh	Continuous retry
FAh	SECURITY_LEVEL	Reports the security level	Read	Hex	01h	Public security level
FBh	PRIVATE_PASSWORD	Sets the private password string	R/W	ASC	00...00h	<null>
FCh	PUBLIC_PASSWORD	Sets the public password string	R/W	ASC	00...00h	<null>
FDh	UNPROTECT	Identifies which commands are protected	R/W	Custom	FF...FFh	No commands are protected

## 24. POWER MANAGEMENT BUS USE GUIDELINES

The Power Management bus is a powerful tool that allows the user to optimize circuit performance by configuring the MODULE for their application. When configuring the MODULE in a circuit, the MODULE should be disabled whenever most settings are changed with Power Management bus commands. Some exceptions to this recommendation are OPERATION, ON\_OFF\_CONFIG, CLEAR\_FAULTS, VOUT\_COMMAND, VOUT\_MARGIN\_HIGH, VOUT\_MARGIN\_LOW and ASCCR\_CONFIG. While the device is enabled any command can be read. Many commands do not take effect until after the device has been reenabled, hence the recommendation that commands that change device settings are written while the device is disabled.

When sending the STORE\_DEFAULT\_ALL, STORE\_USER\_ALL, RESTORE\_DEFAULT\_ALL and RESTORE\_USER\_ALL commands, it is recommended that no other commands are sent to the device for 100ms after sending STORE or RESTORE commands.

In addition, there should be a 2ms delay between repeated READ commands sent to the same device. When sending any other command, a 5ms delay is recommended between repeated commands sent to the same device.

## 25. SUMMARY

All commands can be read at any time.

Always disable the MODULE when writing commands that change device settings. Exceptions to this rule are commands intended to be written while the device is enabled, for example, VOUT\_MARGIN\_HIGH.

To be sure a change to a device setting has taken effect, write the STORE\_USER\_ALL command, then cycle input power and reenable the device.

## 26. POWER MANAGEMENT BUS DATA FORMATS

### Linear-11 (L11)

L11 data format uses 5-bit two's complement exponent (N) and 11-bit two's complement mantissa (Y) to represent real world decimal value (X).

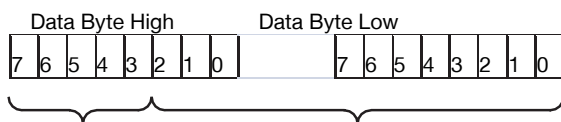

Exponent (N)

Mantissa (Y)

Relation between real world decimal value (X), N and Y is:  $X = Y \cdot 2^N$

### Linear-16 Unsigned (L16u)

L16u data format uses a fixed exponent (hard-coded to  $N = -13$ ) and a 16-bit unsigned integer mantissa (Y) to represent real world decimal value (X). Relation between real world decimal value (X), N and Y is:  $X = Y \cdot 2^{-13}$

### Linear-16 Signed (L16s)

L16s data format uses a fixed exponent (hard-coded to  $N = -13$ ) and a 16-bit two's complement mantissa (Y) to represent real world decimal value (X).

Relation between real world decimal value (X), N and Y is:  $X = Y \cdot 2^{-13}$

### Bit Field (BIT)

Breakdown of Bit Field is provided in ["Power Management bus Command Detail"](#).



Asia-Pacific  
+86 755 298 85888

Europe, Middle East  
+353 61 225 977

North America  
+1 408 785 5200

**Custom (CUS)**

Breakdown of Custom data format is provided in "[Power Management bus Command Detail](#)". A combination of Bit Field and integer are common type of Custom data format.

**ASCII (ASC)**

A variable length string of text characters uses ASCII data format

**27. POWER MANAGEMENT BUS COMMAND DETAIL****PAGE (00h)**

Definition: Selects Controller 0, Controller 1 or both Controllers 0 and 1 to receive commands. All commands following this command will be received and acted on by the selected controller or controllers.

Data Length in Bytes: 1

Data Format: Bit Field

Type: R/W

Protectable: No

Default Value: 00h (Page 0)

Units: N/A

COMMAND	PAGE (00h)							
Format	Bit Field							
Bit Position	7	6	5	4	3	2	1	0
Access	R/W	R/W	R/W	R/W	R/W	R/W	R/W	R/W
Function	See Following Table							
Default Value	0	0	0	0	0	0	0	0

BITS 7:4	BITS 3:0	PAGE
0	0	0
0	1	1
1111	1111	Both



**Asia-Pacific**  
+86 755 298 85888

**Europe, Middle East**  
+353 61 225 977

**North America**  
+1 408 785 5200

**OPERATION (01h)**

Definition: Sets Enable, Disable and VOUT Margin settings. This command can also be monitored to read the operating state of the device on bits 7:6. Writing Immediate off will turn off the output and ignore TOFF\_DELAY and TOFF\_FALL settings. This command is not stored like other Power Management bus commands. The value read reflects the current state of the device. When this command is written the command takes effect, but if a STORE\_USER\_ALL written and the device is reenabled, the OPERATION settings may not be the same settings that were written before the device was reenabled.

Paged or Global: Paged

Data Length in Bytes: 1

Data Format: Bit Field

Type: R/W

Protectable: Yes

Default Value: 00h (immediate off)

Units: N/A

COMMAND	OPERATION (01h)							
Format	Bit Field							
Bit Position	7	6	5	4	3	2	1	0
Access	R/W	R/W	R/W	R/W	R/W	R/W	R/W	R/W
Function	See Following Table							
Default Value	0	0	0	0	0	0	0	0

BITS 7:6	BITS 5:4	BITS 3:0 (NOT USED)	UNIT ON OR OFF	MARGIN STATE
0	0	0	Immediate off (No sequencing)	N/A
1	0	0	Soft off (With sequencing)	N/A
10	0	0	On	Nominal
10	1	0	On	Margin Low
10	10	0	On	Margin High

**NOTE:** Bit combinations not listed above may cause command errors.

**ON\_OFF\_CONFIG (02h)**

Definition: Configures the interpretation and coordination of the OPERATION command and the ENABLE pin (EN). When bit 0 is set to 1 (turn off the output immediately), the TOFF\_FALL setting is ignored.

Paged or Global: Paged

Data Length in Bytes: 1

Data Format: Bit Field

Type: R/W

Protectable: Yes

Default Value: 17h (ENABLE pin control, active high, turn off output immediately – no ramp down)

Units: N/A



COMMAND	ON_OFF_CONFIG (02h)							
Format	Bit Field							
Bit Position	7	6	5	4	3	2	1	0
Access	R/W	R/W	R/W	R/W	R/W	R/W	R/W	R/W
Function	See Following Table							
Default Value	0	0	0	1	0	1	1	1

BIT NUMBER	PURPOSE	BIT VALUE	MEANING
7:5	Not Used	000	Not used
4:2	Sets the default to either operate any time power is present or for the on/off to be controlled by ENABLE pin or OPERATION command	000	Not used
		101	Device starts from ENABLE pin only.
		110	Device starts from OPERATION command only.
1	(Polarity of ENABLE pin - not used)	1	Active high only.
0	ENABLE pin action when commanding the unit to turn off	0	Use the configured ramp-down settings ("soft-off")
		1	Turn off the output immediately.

**CLEAR\_FAULTS (03h)**

Definition: Clears all fault bits in all registers and releases the SALRT pin (if asserted) simultaneously. If a fault condition still exists, the bit will reassert immediately. This command will not restart a device if it has shut down, it will only clear the faults.

Paged or Global: Global

Data Length in Bytes: 0 Byte

Data Format: N/A

Type: Write only

Protectable: Yes

Default Value: N/A

Units: N/A

**STORE\_DEFAULT\_ALL (11h)**

Definition: Stores all current Power Management bus values from the operating memory into the nonvolatile DEFAULT Store memory. To clear the DEFAULT store, perform a RESTORE\_FACTORY then STORE\_DEFAULT\_ALL. To add to the DEFAULT store, perform a RESTORE\_DEFAULT\_ALL, write commands to be added, then STORE\_DEFAULT\_ALL. This command should not be used during device operation, the device will be unresponsive for 100ms while storing values.

Paged or Global: Global

Data Length in Bytes: 0

Data Format: N/A

Type: Write only

Default Value: N/A

Units: N/A



Asia-Pacific  
+86 755 298 85888

Europe, Middle East  
+353 61 225 977

North America  
+1 408 785 5200

**RESTORE\_DEFAULT\_ALL (12h)**

Definition: Restores Power Management bus settings from the nonvolatile DEFAULT store memory into the operating memory. These settings are loaded during at power-up if not superseded by settings in USER store. Security level is changed to level 1 following this command. This command should not be used during device operation, the device will be unresponsive for 100ms while storing values.

Paged or Global: Global

Data Length in Bytes: 0

Data Format: N/A

Type: Write only

Default Value: N/A

Units: N/A

**STORE\_USER\_ALL (15h)**

Definition: Stores all Power Management bus settings from the operating memory to the nonvolatile USER store memory. To clear the USER store, perform a RESTORE\_FACTORY then STORE\_USER\_ALL. To add to the USER store, perform a RESTORE\_USER\_ALL, write commands to be added, then STORE\_USER\_ALL. This command should not be used during device operation, the device will be unresponsive for 100ms while storing values.

Paged or Global: Global

Data Length in Bytes: 0

Data Format: N/A

Type: Write only

Default Value: N/A

Units: N/A

**RESTORE\_USER\_ALL (16h)**

Definition: Restores all Power Management bus settings from the USER store memory to the operating memory. Command performed at power-up. Security level is changed to Level 1 following this command. This command should not be used during device operation, the device will be unresponsive for 100ms while restoring values.

Paged or Global: Global

Data Length in Bytes: 0

Data Format: N/A

Type: Write only

Default Value: N/A

Units: N/A

### VOUT\_MODE (20h)

Definition: Reports the VOUT mode and provides the exponent used in calculating several VOUT settings.

Data Length in Bytes: 1

Data Format: BIT

Type: Read Only

Default Value: 13h (Linear Mode, Exponent = -13)

Units: N/A

COMMAND	VOUT_MODE (20h)							
Format	Bit Field							
Bit Position	7	6	5	4	3	2	1	0
Access	R	R	R	R	R	R	R	R
Function	See Following Table							
Default Value	0	0	0	1	0	0	1	1

MODE	BITS 7:5	BITS 4:0 (PARAMETER)
Linear	000	5-bit two's complement exponent for the mantissa delivered as the data bytes for an output voltage related command.

### VOUT\_COMMAND (21h)

Definition: This command sets or reports the target output voltage. The integer value is multiplied by 2 raised to the power of -13h. This command cannot be set to be higher than 115% of the pin-strap VSET setting, or VOUT\_MAX if VOUT\_MAX is set higher than 115% of the pin-strap VSET setting.

Paged or Global: Paged

Data Length in Bytes: 2

Data Format: Linear -16 Unsigned

Type: R/W

Protectable: Yes

Default Value: VSET pin-strap setting

Units: Volts

Equation:  $VOUT = VOUT\_COMMAND \times 2^{-13}$

Range: 0 to VOUT\_MAX

Example:  $VOUT\_COMMAND = 699Ah = 27,034$

Target voltage equals  $27034 \times 2^{-13} = 3.3V$

COMMAND	VOUT_COMMAND (21h)															
Format	Linear-16 Unsigned															
Bit Position	15	14	13	12	11	10	9	8	7	6	5	4	3	2	1	0
Access	R/W	R/W	R/W	R/W	R/W	R/W	R/W	R/W	R/W	R/W	R/W	R/W	R/W	R/W	R/W	R/W
Default Value	VSET Pin-strap Setting															



Asia-Pacific  
+86 755 298 85888

Europe, Middle East  
+353 61 225 977

North America  
+1 408 785 5200



**VOUT\_TRIM (22h)**

Definition: The VOUT\_TRIM command is used to apply a fixed trim voltage to the output voltage command value. This command is typically used by the manufacturer of a power supply subassembly to calibrate a device in the subassembly circuit. The two bytes are formatted as a two's complement binary mantissa, used in conjunction with the exponent of -13h.

Paged or Global: Paged

Data Length in Bytes: 2

Data Format: Linear -16 Signed

Type: R/W

Protectable: Yes

Default Value: 0000h

Units: Volts

Equation:  $VOUT\ trim = VOUT\_TRIM \times 2^{-13}$

Range:  $\pm 150mV$

COMMAND	VOUT_TRIM (22h)															
Format	Linear-16 Signed															
Bit Position	15	14	13	12	11	10	9	8	7	6	5	4	3	2	1	0
Access	R/W	R/W	R/W	R/W	R/W	R/W	R/W	R/W	R/W	R/W	R/W	R/W	R/W	R/W	R/W	R/W
Default Value	0	0	0	0	0	0	0	0	0	0	0	0	0	0	0	0

**VOUT\_CAL\_OFFSET (23h)**

Definition: The VOUT\_CAL\_OFFSET command is used to apply a fixed offset voltage to the output voltage command value. This command is typically used by the user to calibrate a device in the application circuit. The two bytes are formatted as a two's complement binary mantissa, used in conjunction with the exponent of -13h.

Paged or Global: Paged

Data Length in Bytes: 2

Data Format: Linear -16 Signed

Type: R/W

Protectable: Yes

Default Value: 0000h

Units: Volts

Equation:  $VOUT\ calibration\ offset = VOUT\_CAL\_OFFSET \times 2^{-13}$

Range:  $\pm 150mV$

COMMAND	VOUT_CAL_OFFSET (23h)															
Format	Linear-16 Signed															
Bit Position	15	14	13	12	11	10	9	8	7	6	5	4	3	2	1	0
Access	R/W	R/W	R/W	R/W	R/W	R/W	R/W	R/W	R/W	R/W	R/W	R/W	R/W	R/W	R/W	R/W
Default Value	0	0	0	0	0	0	0	0	0	0	0	0	0	0	0	0

**VOUT\_MAX (24h)**

Definition: The VOUT\_MAX command sets an upper limit on the output voltage the unit can command regardless of any other commands or combinations. The intent of this command is to provide a safeguard against a user accidentally setting the output voltage to a possibly destructive level rather than to be the primary output overprotection. If a VOUT\_COMMAND is sent with a value higher than VOUT\_MAX, the device will set the output voltage to VOUT\_MAX. Note that this command setting does not automatically scale with a stored VOUT\_COMMAND setting.

Paged or Global: Paged

Data Length in Bytes: 2

Data Format: Linear -16 Unsigned

Type: R/W

Protectable: Yes

Default Value: 1.15 x VSET pin-strap setting

Units: Volts

Equation:  $VOUT_{max} = VOUT\_MAX \times 2^{-13}$

Range: 0V to 5.5V

COMMAND	VOUT_MAX (24h)															
Format	Linear-16 Unsigned															
Bit Position	15	14	13	12	11	10	9	8	7	6	5	4	3	2	1	0
Access	R/W	R/W	R/W	R/W	R/W	R/W	R/W	R/W	R/W	R/W	R/W	R/W	R/W	R/W	R/W	R/W
Default Value	1.15 x VSET Pin-strap Setting															

**VOUT\_MARGIN\_HIGH (25h)**

Definition: Sets the value of the VOUT during a margin high. This VOUT\_MARGIN\_HIGH command loads the unit with the voltage to which the output is to be changed when the OPERATION command is set to "Margin High".

Paged or Global: Paged

Data Length in Bytes: 2

Data Format: Linear-16 Unsigned

Type: R/W word

Protectable: Yes

Default Value: 1.05 x VSET pin-strap setting.

Units: V

Equation:  $VOUT_{margin\ high} = VOUT\_MARGIN\_HIGH \times 2^{-13}$

Range: 0V to VOUT\_MAX

COMMAND	VOUT_MARGIN_HIGH (25h)															
Format	Linear-16 Unsigned															
Bit Position	15	14	13	12	11	10	9	8	7	6	5	4	3	2	1	0
Access	R/W	R/W	R/W	R/W	R/W	R/W	R/W	R/W	R/W	R/W	R/W	R/W	R/W	R/W	R/W	R/W
Default Value	1.05 x VSET Pin-strap Setting															

**VOUT\_MARGIN\_LOW (26h)**

Definition: Sets the value of the VOUT during a margin low. This VOUT\_MARGIN\_LOW command loads the unit with the voltage to which the output is to be changed when the OPERATION command is set to “Margin Low”.

Paged or Global: Paged

Data Length in Bytes: 2

Data Format: Linear-16 Unsigned.

Type: R/W

Protectable: Yes

Default Value: 0.95 x VSET pin-strap setting.

Units: V

Equation: VOUT margin low = VOUT\_MARGIN\_LOW

Range: 0V to VOUT\_MAX

COMMAND	VOUT_MARGIN_LOW (26h)															
Format	Linear-16 Unsigned															
Bit Position	15	14	13	12	11	10	9	8	7	6	5	4	3	2	1	0
Access	R/W	R/W	R/W	R/W	R/W	R/W	R/W	R/W	R/W	R/W	R/W	R/W	R/W	R/W	R/W	R/W
Default Value	0.95 x VSET Pin-strap Setting															

**VOUT\_TRANSITION\_RATE (27h)**

Definition: This command sets the rate at which the output should change voltage when the device receives an OPERATION command (Margin High, Margin Low) that causes the output voltage to change. The maximum possible positive value of the two data bytes indicates that the device should make the transition as quickly as possible. This commanded rate does not apply when the device is commanded to turn on or to turn off.

Paged or Global: Paged

Data Length in Bytes: 2

Data Format: Linear-11

Type: R/W

Protectable: Yes

Default Value: BA00h (1.0V/ms)

Units: V/ms

Equation: VOUT\_TRANSITION\_RATE = Y×2<sup>N</sup>

Range: 0.1 to 4V/ms

COMMAND	VOUT_TRANSITION_RATE (27h)															
Format	Linear-11															
Bit Position	15	14	13	12	11	10	9	8	7	6	5	4	3	2	1	0
Access	R/W	R/W	R/W	R/W	R/W	R/W	R/W	R/W	R/W	R/W	R/W	R/W	R/W	R/W	R/W	R/W
Function	Signed Exponent, N						Signed Mantissa, Y									
Default Value	1	0	1	1	1	0	1	0	0	0	0	0	0	0	0	0



Asia-Pacific  
+86 755 298 85888

Europe, Middle East  
+353 61 225 977

North America  
+1 408 785 5200

**VOUT\_DROOP (28h)**

Definition: The VOUT\_DROOP sets the effective load line (V/I slope) for the rail in which the device is used. It is the rate, in mV/A at which the output voltage decreases with increasing output current for use with passive current sharing schemes. For devices that are set to sink output current (negative output current), the output voltage continues to increase as the output current is negative.

VOUT\_DROOP is not needed with a single (2-phase) ZL8802. VOUT\_DROOP is needed when multiple ZL8802s are operated in current sharing mode, i.e., 4-, 6- and 8-phase configurations. In this case, VOUT\_DROOP is calculated based on the combined output current of all phases as applicable.

Paged or Global: Paged

Data Length in Bytes: 2

Data Format: Linear-11

Type: R/W

Protectable: Yes

Default Value: Set by CFG pin-strap setting

Units: mV/A

Equation:  $VOUT\_DROOP = Y \times 2^N$

Range: 0 to 40mV/A

COMMAND	VOUT_DROOP (28h)															
Format	Linear-11															
Bit Position	15	14	13	12	11	10	9	8	7	6	5	4	3	2	1	0
Access	R/W	R/W	R/W	R/W	R/W	R/W	R/W	R/W	R/W	R/W	R/W	R/W	R/W	R/W	R/W	R/W
Function	Signed Exponent, N					Signed Mantissa, Y										
Default Value	Set by CFG Pin-strap Setting															

**FREQUENCY\_SWITCH (33h)**

Definition: Sets the switching frequency of the device. Initial default value is defined by a pin-strap and this value can be overridden by writing this command. If an external SYNC is utilized, this value should be set as close as possible to the external clock value. The output must be disabled when writing this command. Available frequencies are defined by the equation  $f_{SW} = 16\text{MHz}/n$  where

12 ≤ n ≤ 80.

Paged or Global: Global

Data Length in Bytes: 2

Data Format: Linear-11

Type: R/W

Protectable: Yes

Default Value: SYNC pin-strap setting

Units: kHz

Equation:  $FREQUENCY\_SWITCH = Y \times 2^N$

Range: 200kHz-1.33MHz



COMMAND	FREQUENCY_SWITCH (33h)															
Format	Linear-11															
Bit Position	15	14	13	12	11	10	9	8	7	6	5	4	3	2	1	0
Access	R/W	R/W	R/W	R/W	R/W	R/W	R/W	R/W	R/W	R/W	R/W	R/W	R/W	R/W	R/W	R/W
Function	Signed Exponent, N						Signed Mantissa, Y									
Default Value	SYNC Pin-strapped Value															

**INTERLEAVE (37h)**

Definition: Configures the phase offset of a device that is sharing a common SYNC clock with other devices. A desired phase position is specified. Interleave is used for setting the phase offset between individual devices, current sharing groups, and/or combinations of devices and current sharing groups. For devices within single current sharing group the phase offset is set automatically. In a multiphase current share group the same interleave settings must be stored in all devices in the current sharing group in order to phase spread properly. Interleave Offset refers to the phase offset of Phase 0 of the device; Phase 1 is always Phase 0 + 180 degrees.

INTERLEAVE Phase offset is calculated with [Equation](#):

$$\text{Phase Offset (in degrees)} = \text{Rounded Position} \cdot 16 \text{ Number} \cdot 22.5$$

Phase offsets greater than 360 degrees are “wrapped around” by subtracting 360 degrees.

Paged or Global: Paged

Data Length in Bytes: 2

Data Format: Bit Field

Type: R/W

Protectable: Yes

Default Value: Set by CFG pin-strap setting.

Units: N/A

COMMAND	INTERLEAVE (37h)															
Format	Bit Field															
Bit Position	15	14	13	12	11	10	9	8	7	6	5	4	3	2	1	0
Access	R/W	R/W	R/W	R/W	R/W	R/W	R/W	R/W	R/W	R/W	R/W	R/W	R/W	R/W	R/W	R/W
Function	See Following Table															
Default Value	Set by CFG Pin-strap Setting															

BITS	PURPOSE	VALUE	DESCRIPTION
15:8	Not Used	0	Not used
7:4	Number In Group	0 to 15d	Sets the number of devices in the interleave group. A value of 0 is interpreted as 16.
3:0	Position in Group (Interleave Order)	0 to 15d	Sets position of the device’s rail within the group. A value of 0 is interpreted as 16. Position 1 will have a 22.5 degree offset.



Asia-Pacific  
+86 755 298 85888

Europe, Middle East  
+353 61 225 977

North America  
+1 408 785 5200

**IOUT\_CAL\_GAIN (38h)**

Definition: Sets the effective impedance across the current sense circuit for use in calculating output current at +25°C.

Paged or Global: Paged

Data Length in Bytes: 2

Data Format: Linear-11

Type: R/W

Protectable: Yes

Default Value: B2AEh (0.67mfi)

Units: mfi

Equation:  $IOUT\_CAL\_GAIN = Y \times 2^N$

COMMAND	IOUT_CAL_GAIN (38h)															
Format	Linear-11															
Bit Position	15	14	13	12	11	10	9	8	7	6	5	4	3	2	1	0
Access	R/W	R/W	R/W	R/W	R/W	R/W	R/W	R/W	R/W	R/W	R/W	R/W	R/W	R/W	R/W	R/W
Function	Signed Exponent, N					Signed Mantissa, Y										
Default Value	1	0	1	1	0	0	1	0	1	0	1	0	1	1	1	0

**IOUT\_CAL\_OFFSET (39h)**

Definition: Used to null out any offsets in the output current sensing circuit, and to compensate for delayed measurements of current ramp due to the current sense blanking time (see "[ISENSE\\_CONFIG \(D0h\)](#)").

Paged or Global: Paged

Data Length in Bytes: 2

Data Format: Linear-11

Type: R/W

Protectable: Yes

Default Value: BD00h (-1.5A)

Units: A

Equation:  $IOUT\_CAL\_OFFSET = Y \times 2^N$

COMMAND	IOUT_CAL_OFFSET (39h)															
Format	Linear-11															
Bit Position	15	14	13	12	11	10	9	8	7	6	5	4	3	2	1	0
Access	R/W	R/W	R/W	R/W	R/W	R/W	R/W	R/W	R/W	R/W	R/W	R/W	R/W	R/W	R/W	R/W
Function	Signed Exponent, N					Signed Mantissa, Y										
Default Value	1	0	1	1	1	1	0	1	0	0	0	0	0	0	0	0

### VOUT\_OV\_FAULT\_LIMIT (40h)

Definition: Sets the VOUT overvoltage fault threshold.

Paged or Global: Paged

Data Length in Bytes: 2

Data Format: Linear-16 Unsigned

Type: R/W

Protectable: Yes

Default Value: 1.10 x VSET pin-strap setting.

Units: V

Equation:  $VOUT\ OV\ fault\ limit = VOUT\_OV\_FAULT\_LIMIT \times 2^{-13}$

Range: 0V to 7.99V

COMMAND	VOUT_OV_FAULT_LIMIT (40h)															
Format	Linear-16 Unsigned															
Bit Position	15	14	13	12	11	10	9	8	7	6	5	4	3	2	1	0
Access	R/W	R/W	R/W	R/W	R/W	R/W	R/W	R/W	R/W	R/W	R/W	R/W	R/W	R/W	R/W	R/W
Default Value	1.10 x VSET Pin-strap Setting															

### VOUT\_OV\_FAULT\_RESPONSE (41h)

Definition: Configures the VOUT overvoltage fault response. The retry time is the time between restart attempts.

Paged or Global: Paged

Data Length in Bytes: 1

Data Format: Bit Field

Type: R/W

Protectable: Yes

Default Value: 80h (shut down immediately, no retries)

Units: Retry time = 35ms increments

COMMAND	VOUT_OV_FAULT_RESPONSE (41h)							
Format	Bit Field							
Bit Position	7	6	5	4	3	2	1	0
Access	R/W	R/W	R/W	R/W	R/W	R/W	R/W	R/W
Function	See Following Table							
Default Value	1	0	0	0	0	0	0	0



BIT	FIELD NAME	VALUE	DESCRIPTION
7:6	Response behavior, the device: • Pulls SALRT low • Sets the related fault bit in the status registers. Fault bits are only cleared by the CLEAR_FAULTS command.	00-01	Not used
		10-11	Disable and retry according to the setting in bits [5:3].
5:3	Retry Setting	000	No retry. The output remains disabled until the device is restarted.
		001-110	Not used
		111	Attempts to restart continuously, until it is commanded OFF (by the ENABLE pin or OPERATION command or both), bias power is removed, or another fault condition causes the unit to shut down. The time between the start of each attempt to restart is set by the value in bits [2:0] multiplied by 35ms.
2:0	Retry Delay	000-111	Retry delay time = (Value +1)*35ms. Sets the time between retries in 35ms increments. Range is 35ms to 280ms.

**VOUT\_UV\_FAULT\_LIMIT (44h)**

Definition: Sets the VOUT undervoltage fault threshold. This fault is masked during ramp, before power-good is asserted or when the device is disabled. VOUT\_UV\_FAULT\_LIMIT should be set to a value below POWER\_GOOD

Paged or Global: Paged

Data Length in Bytes: 2

Data Format: Linear-16 Unsigned.

Type: R/W

Protectable: Yes

Default Value: 0.85 x VSET pin-strap setting.

Units: V

Equation: VOUT UV fault limit = VOUT\_UV\_FAULT\_LIMIT × 2<sup>-13</sup>

Range: 0V to 7.99V

COMMAND	VOUT_UV_FAULT_LIMIT (44h)															
Format	Linear-16 Unsigned															
Bit Position	15	14	13	12	11	10	9	8	7	6	5	4	3	2	1	0
Access	R/W	R/W	R/W	R/W	R/W	R/W	R/W	R/W	R/W	R/W	R/W	R/W	R/W	R/W	R/W	R/W
Default Value	0.85 x VSET Pin-strap Setting															

**VOUT\_UV\_FAULT\_RESPONSE (45h)**

Definition: Configures the VOUT undervoltage fault response. Note that VOUT UV faults can only occur after Power-good (PG) has been asserted. Under some circumstances this will cause the output to stay fixed below the power-good threshold indefinitely. If this behavior is undesired, use setting 80h. The retry time is the time between restart attempts.

Paged or Global: Paged

Data Length in Bytes: 1

Data Format: Bit Field

Type: R/W

Protectable: Yes

Default Value: 80h (shut down immediately, no retries)

Units: Retry time unit = 35ms

COMMAND	VOUT_UV_FAULT_RESPONSE (45h)							
Format	Bit Field							
Bit Position	7	6	5	4	3	2	1	0
Access	R/W	R/W	R/W	R/W	R/W	R/W	R/W	R/W
Function	See Following Table							
Default Value	1	0	0	0	0	0	0	0

### VOUT\_UV\_FAULT\_RESPONSE (45h)

BIT	FIELD NAME	VALUE	DESCRIPTION
7:6	Response Behavior: the device: • Pulls SALRT low • Sets the related fault bit in the status registers. Fault bits are only cleared by the CLEAR_FAULTS command.	00-01	Not used
		10-11	Disable and Retry according to the setting in bits [5:3].
5:3	Retry Setting	000	No retry. The output remains disabled until the fault is cleared.
		001-110	Not used
		111	Attempts to restart continuously, until it is commanded OFF (by the ENABLE pin or OPERATION command or both), bias power is removed, or another fault condition causes the unit to shut down. The time between the start of each attempt to restart is set by the value in bits [2:0] multiplied by 35ms.
2:0	Retry Delay	000-111	Retry delay time = (Value+1)*35ms. Sets the time between retries in 35ms increments. Range is 35ms to 280ms.

### IOUT\_OC\_FAULT\_LIMIT (46h)

Definition: Sets the IOUT peak overcurrent fault threshold. This limit is applied to current measurement samples taken after the Current Sense Blanking Time has expired (see "ISENSE\_CONFIG(D0h)"). A fault occurs after this limit is exceeded for the number of consecutive samples as defined in ISENSE\_CONFIG. This feature shares the OC fault bit operation (in STATUS\_IOUT) and OC fault response with IOUT\_AVG\_OC\_FAULT\_LIMIT.

Paged or Global: Paged

Data Length in Bytes: 2

Data Format: Linear-11

Type: R/W

Protectable: Yes

Default Value: CFG pin-strap setting

Units: A

Equation:  $IOUT\_OC\_FAULT\_LIMIT = Y \times 2^N$

Range: -100A to 100A

COMMAND	IOUT_OC_FAULT_LIMIT(46h)															
Format	Linear-11															
Bit Position	15	14	13	12	11	10	9	8	7	6	5	4	3	2	1	0
Access	R/W	R/W	R/W	R/W	R/W	R/W	R/W	R/W	R/W	R/W	R/W	R/W	R/W	R/W	R/W	R/W
Function	Signed Exponent, N								Signed Mantissa, Y							



Asia-Pacific  
+86 755 298 85888

Europe, Middle East  
+353 61 225 977

North America  
+1 408 785 5200

Default Value	CFG Pin-strap Setting
---------------	-----------------------

**IOUT\_UC\_FAULT\_LIMIT (4Bh)**

Definition: Sets the IOUT valley undercurrent fault threshold. This limit is applied to current measurement samples taken after the Current Sense Blanking Time has expired. A fault occurs after this limit is exceeded for the number of consecutive sample as defined in ISENSE\_CONFIG. This feature shares the UC fault bit operation (in STATUS\_IOUT) and UC fault response with IOUT\_AVG\_UC\_FAULT\_LIMIT.

Paged or Global: Paged

Data Length in Bytes: 2

Data Format: Linear-11

Type: R/W

Protectable: Yes

Default Value:  $-1 * IOUT\_OC\_FAULT\_LIMIT$  from CFG pin-strap setting

Units: A

Equation:  $IOUT\_OC\_FAULT\_LIMIT = Y \times 2^N$

Range: -100A to 100A

COMMAND	IOUT_UC_FAULT_LIMIT (4Bh)															
Format	Linear-11															
Bit Position	15	14	13	12	11	10	9	8	7	6	5	4	3	2	1	0
Access	R/W	R/W	R/W	R/W	R/W	R/W	R/W	R/W	R/W	R/W	R/W	R/W	R/W	R/W	R/W	R/W
Function	Signed Exponent, N								Signed Mantissa, Y							
Default Value	$-1 * IOUT\_OC\_FAULT\_LIMIT$ from CFG Pin-strap Setting															

**OT\_FAULT\_LIMIT (4Fh)**

Definition: The OT\_FAULT\_LIMIT command sets the temperature at which the device should indicate an over-temperature fault.

Paged or Global: Paged

Data Length in Bytes: 2

Data Format: Linear-11

Type: R/W

Protectable: Yes

Default Value: EBE8h (+125°C)

Units: Celsius

Equation:  $OT\_FAULT\_LIMIT = Y \times 2^N$

Range: 0 to 175°C

COMMAND	OT_FAULT_LIMIT(4Fh)															
Format	Linear-11															
Bit Position	15	14	13	12	11	10	9	8	7	6	5	4	3	2	1	0
Access	R/W	R/W	R/W	R/W	R/W	R/W	R/W	R/W	R/W	R/W	R/W	R/W	R/W	R/W	R/W	R/W
Function	Signed Exponent, N								Signed Mantissa, Y							
Default Value	1	1	1	0	1	0	1	1	1	1	1	0	1	0	0	0

**OT\_FAULT\_RESPONSE (50h)**

Definition: The OT\_FAULT\_RESPONSE command instructs the device on what action to take in response to an over-temperature fault. The retry time is the time between restart attempts.

Paged or Global: Paged

Data Length in Bytes: 1

Data Format: Bit Field

Type: R/W

Protectable: Yes

Default Value: BFh (Continuous retries, retry delay 280ms)

Units: Retry time unit = 35ms

COMMAND	OT_FAULT_RESPONSE(50h)							
Format	Bit Field							
Bit Position	7	6	5	4	3	2	1	0
Access	R/W	R/W	R/W	R/W	R/W	R/W	R/W	R/W
Function	See Following Table							
Default Value	1	0	1	1	1	1	1	1

**OT\_FAULT\_RESPONSE (50h)**

BIT	FIELD NAME	VALUE	DESCRIPTION
7:6	Response Behavior: the device: Pulls SALRT low Sets the related fault bit in the status registers. Fault bits are only cleared by the CLEAR_FAULTS command.	00-01	Not used
		10	Disable and Retry according to the setting in bits [5:3].
		11	Output is disabled while the fault is present. Operation resumes and the output is enabled when the temperature falls below the OT_WARN_LIMIT.
5:3	Retry Setting	000	No retry. The output remains disabled until the fault is cleared.
		001-110	Not used
		111	Attempts to restart continuously, until it is commanded OFF (by the ENABLE pin or OPERATION command or both), bias power is removed, or another fault condition causes the unit to shut down. A retry is attempted after the temperature falls below the OT_WARN_LIMIT. The time between the start of each attempt to restart is set by the value in bits [2:0] multiplied by 35ms.
2:0	Retry Delay	000-111	Retry delay time = (Value +1)*35ms. Sets the time between retries in 35ms increments. Range is 35ms to 280ms.

**OT\_WARN\_LIMIT (51h)**

Definition: The OT\_WARN\_LIMIT command sets the temperature at which the device should indicate an over-temperature warning alarm. In response to the OT\_WARN\_LIMIT being exceeded, the device: Sets the TEMPERATURE bit in STATUS\_WORD, sets the OT\_WARNING bit in STATUS\_TEMPERATURE and notifies the host.

Paged or Global: Paged

Data Length in Bytes: 2

Data Format: Linear-11

Type: R/W

Protectable: Yes

Default Value: EB70h (+110°C)

Units: Celsius

Equation:  $OT\_WARN\_LIMIT = Y \times 2^N$

Range: 0 to 175°C

COMMAND	OT_WARN_LIMIT (51h)															
Format	Linear-11															
Bit Position	15	14	13	12	11	10	9	8	7	6	5	4	3	2	1	0
Access	R/W	R/W	R/W	R/W	R/W	R/W	R/W	R/W	R/W	R/W	R/W	R/W	R/W	R/W	R/W	R/W
Function	Signed Exponent, N					Signed Mantissa, Y										
Default Value	1	1	1	0	1	0	1	1	0	1	1	1	0	0	0	0

**UT\_WARN\_LIMIT (52h)**

Definition: The UT\_WARN\_LIMIT command set the temperature at which the device should indicate an under-temperature warning alarm. In response to the UT\_WARN\_LIMIT being exceeded, the device: Sets the TEMPERATURE bit in STATUS\_WORD, sets the UT\_WARNING bit in STATUS\_TEMPERATURE and notifies the host.

Paged or Global: Paged

Data Length in Bytes: 2

Data Format: Linear-11

Type: R/W

Protectable: Yes

Default Value: DC40h (-30°C)

Units: Celsius

Equation:  $UT\_WARN\_LIMIT = Y \times 2^N$

Range: -55°C to +25°C

COMMAND	UT_WARN_LIMIT (52h)															
Format	Linear-11															
Bit Position	15	14	13	12	11	10	9	8	7	6	5	4	3	2	1	0
Access	R/W	R/W	R/W	R/W	R/W	R/W	R/W	R/W	R/W	R/W	R/W	R/W	R/W	R/W	R/W	R/W
Function	Signed Exponent, N					Signed Mantissa, Y										
Default Value	1	1	0	1	1	1	0	0	0	0	1	0	0	0	0	0



**UT\_FAULT\_LIMIT (53h)**

Definition: The UT\_FAULT\_LIMIT command sets the temperature, in degrees Celsius, of the unit at which it should indicate an under-temperature fault.

Paged or Global: Paged

Data Length in Bytes: 2

Data Format: Linear-11

Type: R/W

Protectable: Yes

Default Value: E530h (-45°C)

Units: Celsius

Equation:  $UT\_FAULT\_LIMIT = Y \times 2^N$

Range: -55°C to +25°C

COMMAND	UT_FAULT_LIMIT (53h)															
Format	Linear-11															
Bit Position	15	14	13	12	11	10	9	8	7	6	5	4	3	2	1	0
Access	R/W	R/W	R/W	R/W	R/W	R/W	R/W	R/W	R/W	R/W	R/W	R/W	R/W	R/W	R/W	R/W
Function	Signed Exponent, N					Signed Mantissa, Y										
Default Value	1	1	1	0	0	1	0	1	0	0	1	1	0	0	0	0

**UT\_FAULT\_RESPONSE (54h)**

Definition: Configures the under-temperature fault response as defined by the table below. The retry time is the time between restart attempts.

Paged or Global: Paged

Data Length in Bytes: 1

Data Format: Bit Field

Type: R/W

Protectable: Yes

Default Value: BFh (Continuous retries, 280ms retry delay)

Units: Retry time unit = 35ms

COMMAND	UT_FAULT_RESPONSE (54h)							
Format	Bit Field							
Bit Position	7	6	5	4	3	2	1	0
Access	R/W	R/W	R/W	R/W	R/W	R/W	R/W	R/W
Function	See Following Table							
Default Value	1	0	1	1	1	1	1	1



Asia-Pacific  
+86 755 298 85888

Europe, Middle East  
+353 61 225 977

North America  
+1 408 785 5200

BIT	FIELD NAME	VALUE	DESCRIPTION
7:6	Response behavior, the device: Pulls SALRT low Sets the related fault bit in the status registers. Fault bits are only cleared by the CLEAR_FAULTS command.	00-01	Not used
		10	Disable and Retry according to the setting in bits [5:3].
		11	Output is disabled while the fault is present. Operation resumes and the output is enabled when the temperature rises above the UT_WARN_LIMIT.
5:3	Retry Setting	000	No retry. The output remains disabled until the device is restarted.
		001-110	Not used
		111	Attempts to restart continuously, until it is commanded OFF (by the ENABLE pin or OPERATION command or both), bias power is removed, or another fault condition causes the unit to shut down. A retry is attempted after the temperature rises above UT_WARN_LIMIT. The time between the start of each attempt to restart is set by the value in bits [2:0] multiplied by 35ms.
2:0	Retry Delay	000-111	Retry delay time = (Value +1)*35ms. Sets the time between retries in 35ms increments. Range is 35ms to 280ms.

**VIN\_OV\_FAULT\_LIMIT(55h)**

Definition: Sets the VIN overvoltage fault threshold.

Paged or Global: Global

Data Length in Bytes: 2

Data Format: Linear-11

Type: R/W

Protectable: Yes

Default Value: D380h (14V)

Units: V

Equation:  $VIN\_OV\_FAULT\_LIMIT = Y \times 2^N$

Range: 0 to 19V

COMMAND	VIN_OV_FAULT_LIMIT(55h)															
Format	Linear-11															
Bit Position	15	14	13	12	11	10	9	8	7	6	5	4	3	2	1	0
Access	R/W	R/W	R/W	R/W	R/W	R/W	R/W	R/W	R/W	R/W	R/W	R/W	R/W	R/W	R/W	R/W
Function	Signed Exponent, N					Signed Mantissa, Y										
Default Value	1	1	0	1	0	0	1	1	1	1	0	0	0	0	0	0

**VIN\_OV\_FAULT\_RESPONSE (56h)**

Definition: Configures the VIN overvoltage fault response as defined by the table below.

Paged or Global: Global

Data Length in Bytes: 1

Data Format: Bit Field

Type: R/W

Protectable: Yes

Default Value: 80h (Disable, no retry)

Units: N/A

COMMAND	VIN_OV_FAULT_RESPONSE (56h)							
Format	Bit Field							
Bit Position	7	6	5	4	3	2	1	0
Access	R/W	R/W	R/W	R/W	R/W	R/W	R/W	R/W
Function	See Following Table							
Default Value	1	0	0	0	0	0	0	0

BIT	FIELD NAME	VALUE	DESCRIPTION
7:6	Response behavior, the device: Pulls SALRT low Sets the related fault bit in the status registers. Fault bits are only cleared by the CLEAR_FAULTS command.	00-01	Not used
		10	Disable and Retry according to the setting in bits [5:3].
		11	Output is disabled while the fault is present. Operation resumes and the output is enabled when VIN falls below the VIN_OV_WARN_LIMIT.
5:3	Retry Setting	000	No retry. The output remains disabled until the fault is cleared.
		001-110	Not used
		111	Attempts to restart continuously, until it is commanded OFF (by the ENABLE pin or OPERATION command or both), bias power is removed, or another fault condition causes the unit to shut down. A retry is attempted after the output falls below the VIN_OV_WARN_LIMIT. The time between the start of each attempt to restart is set by the value in bits [2:0] multiplied by 35ms.
2:0	Retry Delay	000-111	Retry delay time = (Value + 1)*35ms. Sets the time between retries in 35ms increments. Range is 35ms to 280ms.

**VIN\_OV\_WARN\_LIMIT (57h)**

Definition: Sets the VIN overvoltage warning threshold as defined by the table below. In response to the OV\_WARN\_LIMIT being exceeded, the device: Sets the NONE OF THE ABOVE and INPUT bits in STATUS\_WORD, sets the VIN\_OV\_WARNING bit in STATUS\_INPUT and notifies the host.

Paged or Global: Global

Data Length in Bytes: 2

Data Format: Linear-11

Type: R/W

Protectable: Yes

Default Value: D360h (13.5V)

Units: V

Equation:  $VIN\_OV\_FAULT\_LIMIT = Y \times 2^N$

Range: 0 to 19V

COMMAND	VIN_OV_WARN_LIMIT (57h)															
Format	Linear-11															
Bit Position	15	14	13	12	11	10	9	8	7	6	5	4	3	2	1	0
Access	R/W	R/W	R/W	R/W	R/W	R/W	R/W	R/W	R/W	R/W	R/W	R/W	R/W	R/W	R/W	R/W
Function	Signed Exponent, N						Signed Mantissa, Y									
Default Value	1	1	0	1	0	0	1	1	0	1	1	0	0	0	0	0

**VIN\_UV\_WARN\_LIMIT (58h)**

Definition: Sets the VIN undervoltage warning threshold. If a VIN\_UV\_FAULT occurs, the input voltage must rise above VIN\_UV\_WARN\_LIMIT to clear the fault, which provides hysteresis to the fault threshold. In response to the UV\_WARN\_LIMIT being exceeded, the device: Sets the NONE OF THE ABOVE and INPUT bits in STATUS\_WORD, Sets the VIN\_UV\_WARNING bit in STATUS\_INPUT, and notifies the host.

Paged or Global: Global

Data Length in Bytes: 2

Data Format: Linear-11

Type: R/W

Protectable: Yes

Default Value: 1.10 x UVLO pin-strap setting

Units: V

Equation:  $VIN\_UV\_WARN\_LIMIT = Y \times 2^N$

Range: 0 to 19V

COMMAND	VIN_UV_WARN_LIMIT (58h)															
Format	Linear-11															
Bit Position	15	14	13	12	11	10	9	8	7	6	5	4	3	2	1	0
Access	R/W	R/W	R/W	R/W	R/W	R/W	R/W	R/W	R/W	R/W	R/W	R/W	R/W	R/W	R/W	R/W
Function	Signed Exponent, N						Signed Mantissa, Y									

Default Value	1.10 x UVLO Pin-strap Setting
---------------	-------------------------------

**VIN\_UV\_FAULT\_LIMIT (59h)**

Definition: Sets the VIN undervoltage fault threshold.

Paged or Global: Global

Data Length in Bytes: 2

Data Format: Linear-11

Type: R/W

Protectable: Yes

Default Value: UVLO pin-strap setting

Units: V

Equation:  $VIN\_UV\_FAULT\_LIMIT = Y \times 2^N$

Range: 0 to 19V

COMMAND	VIN_UV_FAULT_LIMIT (59h)															
Format	Linear-11															
Bit Position	15	14	13	12	11	10	9	8	7	6	5	4	3	2	1	0
Access	R/W	R/W	R/W	R/W	R/W	R/W	R/W	R/W	R/W	R/W	R/W	R/W	R/W	R/W	R/W	R/W
Function	Signed Exponent, N								Signed Mantissa, Y							
Default Value	UVLO pin-strappped value															

**VIN\_UV\_FAULT\_RESPONSE (5Ah)**

Definition: Configures the VIN undervoltage fault response as defined by the table below. The retry time is the time between restart attempts.

Paged or Global: Global

Data Length in Bytes: 1

Data Format: Bit Field

Type: R/W

Protectable: Yes

Default Value: BFh (continuous retries, 280ms retry delay)

Units: Retry time unit = 35ms

COMMAND	VIN_UV_FAULT_RESPONSE (5Ah)								
Format	Bit Field								
Bit Position	7	6	5	4	3	2	1	0	
Access	R/W	R/W	R/W	R/W	R/W	R/W	R/W	R/W	
Function	See Following Table								
Default Value	1	0	0	0	0	0	0	0	



Asia-Pacific  
+86 755 298 85888

Europe, Middle East  
+353 61 225 977

North America  
+1 408 785 5200

BIT	FIELD NAME	VALUE	DESCRIPTION
7:6	Response behavior, the device: Pulls SALRT low Sets the related fault bit in the status registers. Fault bits are only cleared by the CLEAR_FAULTS command.	00-01	Not used
		10	Disable and retry according to the setting in bits [5:3].
		11	Output is disabled while the fault is present. Operation resumes and the output is enabled when VIN rises above the VIN_UV_WARN_LIMIT.
5:3	Retry Setting	000	No retry. The output remains disabled until the fault is cleared.
		001-110	Not used
		111	Attempts to restart continuously, until it is commanded OFF (by the ENABLE pin or OPERATION command or both), bias power is removed, or another fault condition causes the unit to shut down. A retry is attempted after the input voltage rises above the VIN_UV_WARN_LIMIT. The time between the start of each attempt to restart is set by the value in bits [2:0] multiplied by 35ms.
2:0	Retry Delay	000-111	Retry delay time = (Value +1)*35ms. Sets the time between retries in 35ms increments. Range is 35ms to 280ms.

#### POWER\_GOOD\_ON (5Eh)

Definition: Sets the voltage threshold for power-good indication. Power-good asserts when the output voltage exceeds POWER\_GOOD\_ON and reasserts when the output voltage is less than VOUT\_UV\_FAULT\_LIMIT. POWER\_GOOD\_ON should be set to a value above VOUT\_UV\_FAULT\_LIMIT.

Paged or Global: Paged

Data Length in Bytes: 2

Data Format: Linear-16 Unsigned

Type: R/W

Protectable: Yes

Default Value: 0.9 x VSET pin-strap setting.

Units: V

COMMAND	POWER_GOOD_ON (5Eh)															
Format	Linear-16 Unsigned															
Bit Position	15	14	13	12	11	10	9	8	7	6	5	4	3	2	1	0
Access	R/W	R/W	R/W	R/W	R/W	R/W	R/W	R/W	R/W	R/W	R/W	R/W	R/W	R/W	R/W	R/W
Default Value	0.9 x VSET Pin-strap Setting															

**TON\_DELAY (60h)**

Definition: Sets the delay time from when the device is enabled to the start of VOUT rise.

Paged or Global: Paged

Data Length in Bytes: 2

Data Format: Linear-11

Type: R/W

Protectable: Yes

Default Value: CA80h (5ms)

Units: ms

Equation:  $TON\_DELAY = Y \times 2^N$

Range: 0 to 5 seconds

COMMAND	TON_DELAY (60h)															
Format	Linear-11															
Bit Position	15	14	13	12	11	10	9	8	7	6	5	4	3	2	1	0
Access	R/W	R/W	R/W	R/W	R/W	R/W	R/W	R/W	R/W	R/W	R/W	R/W	R/W	R/W	R/W	R/W
Function	Signed Exponent, N					Signed Mantissa, Y										
Default Value	1	1	0	0	1	0	1	0	1	0	0	0	0	0	0	0

**TON\_RISE (61h)**

Definition: Sets the rise time of VOUT after ENABLE and TON\_DELAY for single and dual channel operation. To adjust the rise time in 4-, 6- or 8-phase operation, use MULTI\_PHASE\_RAMP\_GAIN (D5h).

Paged or Global: Paged

Data Length in Bytes: 2

Data Format: Linear-11

Type: R/W

Protectable: Yes

Default Value: CA80h (5ms)

Units: ms

Equation:  $TON\_RISE = Y \times 2^N$

Range: 0 to 100ms. Although values can be set below 0.50ms, rise time accuracy cannot be guaranteed. In addition, short rise times may cause excessive input and output currents to flow, thus triggering overcurrent faults at start-up.

COMMAND	TON_RISE (61h)															
Format	Linear-11															
Bit Position	15	14	13	12	11	10	9	8	7	6	5	4	3	2	1	0
Access	R/W	R/W	R/W	R/W	R/W	R/W	R/W	R/W	R/W	R/W	R/W	R/W	R/W	R/W	R/W	R/W
Function	Signed Exponent, N					Signed Mantissa, Y										
Default Value	1	1	0	0	1	0	1	0	1	0	0	0	0	0	0	0

**TOFF\_DELAY (64h)**

Definition: Sets the delay time from DISABLE to start of VOUT fall.

Paged or Global: Paged

Data Length in Bytes: 2

Data Format: Linear-11

Type: R/W

Protectable: Yes

Default Value: CA80h (5ms)

Units: ms

Equation:  $TON\_DELAY = Y \times 2^N$

Range: 0 to 5 seconds

COMMAND	TOFF_DELAY (64h)															
Format	Linear-11															
Bit Position	15	14	13	12	11	10	9	8	7	6	5	4	3	2	1	0
Access	R/W	R/W	R/W	R/W	R/W	R/W	R/W	R/W	R/W	R/W	R/W	R/W	R/W	R/W	R/W	R/W
Function	Signed Exponent, N					Signed Mantissa, Y										
Default Value	1	1	0	0	1	0	1	0	1	0	0	0	0	0	0	0

**TOFF\_FALL (65h)**

Definition: Sets the fall time for VOUT after DISABLE and TOFF\_DELAY. This setting is only valid in single or 2-phase operation. Setting the TOFF\_FALL to values less than 0.5ms will cause the ZL8802 to turn-off both the high and low-side FETs (or disable the DrMOS device) immediately after the expiration of the TOFF\_DELAY time. In 4-, 6- or 8-phase operation, the ZL8802 will always turn-off both the high and low-side FETs (or disable the DrMOS device) immediately after the expiration of the TOFF\_DELAY time.

Paged or Global: Paged

Data Length in Bytes: 2

Data Format: Linear-11

Type: R/W

Protectable: Yes

Default Value: CA80h (5ms)

Units: ms

Equation:  $TOFF\_FALL = Y \times 2^N$

Range: 0 to 100ms. Values less than 0.5ms will cause the ZL8802 to tri-state the PWM signal (turn-off both the high and low-side FETs) immediately after the expiration of the TOFF\_DELAY time.

COMMAND	TOFF_FALL (65h)															
Format	Linear-11															
Bit Position	15	14	13	12	11	10	9	8	7	6	5	4	3	2	1	0
Access	R/W	R/W	R/W	R/W	R/W	R/W	R/W	R/W	R/W	R/W	R/W	R/W	R/W	R/W	R/W	R/W
Function	Signed Exponent, N					Signed Mantissa, Y										
Default Value	1	1	0	0	1	0	1	0	1	0	0	0	0	0	0	0



**STATUS\_BYTE (78h)**

Definition: The STATUS\_WORD command returns two bytes of information with a summary of the unit's fault condition. Based on the information in these bytes, the host can get more information by reading the appropriate status registers. The low byte of the STATUS\_WORD is the same register as the STATUS\_BYTE (78h) command.

Paged or Global: Paged

Data Length in Bytes: 2

Data Format: Bit Field

Type: Read Only

Protectable: No

Default Value: 00h

Units: N/A

COMMAND	STATUS_BYTE (78h)							
Format	Bit Field							
Bit Position	7	6	5	4	3	2	1	0
Access	R	R	R	R	R	R	R	R
Function	See Following Table							
Default Value	0	0	0	0	0	0	0	0

BIT NUMBER	STATUS BIT NAME	MEANING
7	BUSY	A fault was declared because the device was busy and unable to respond.
6	OFF	This bit is asserted if the unit is not providing power to the output, regardless of the reason, including simply not being enabled.
5	VOUT_OV_FAULT	An output overvoltage fault has occurred.
4	IOUT_OC_FAULT	An output overcurrent fault has occurred.
3	VIN_UV_FAULT	An input undervoltage fault has occurred.
2	TEMPERATURE	A temperature fault or warning has occurred.
1	CML	A communications, memory or logic fault has occurred.
0	None of the above	A fault other than the faults listed in bits 7:1 above has occurred. The source of the fault will be in bits 15:8 of the STATUS_WORD

**STATUS\_WORD (79h)**

Definition: The STATUS\_WORD command returns two bytes of information with a summary of the unit's fault condition. Based on the information in these bytes, the host can get more information by reading the appropriate status registers. The low byte of the STATUS\_WORD is the same register as the STATUS\_BYTE (78h) command.

Paged or Global: Paged

Data Length in Bytes: 2

Data Format: Bit Field

Type: Read Only

Protectable: No

Default Value: 0000h

Units: N/A

COMMAND	STATUS_WORD (79h)															
Format	Bit Field															
Bit Position	15	14	13	12	11	10	9	8	7	6	5	4	3	2	1	0
Access	R	R	R	R	R	R	R	R	R	R	R	R	R	R	R	R
Function	See Following Table															
Default Value	0	0	0	0	0	0	0	0	0	0	0	0	0	0	0	0

BIT NUMBER	STATUS BIT NAME	MEANING
15	VOUT	An output voltage fault or warning has occurred.
14	IOUT	An output current fault has occurred.
13	INPUT	An input voltage fault or warning has occurred.
12	MFG_SPECIFIC	A manufacturer specific fault or warning has occurred.
11	POWER_GOOD #	The POWER_GOOD signal, if present, is negated. ( <a href="#">Note 15</a> )
10	NOT USED	Not used
9	OTHER	A bit in STATUS_VOUT, STATUS_IOUT, STATUS_INPUT, STATUS_TEMPERATURE, STATUS_CML, or STATUS_MFR_SPECIFIC is set.
8	Not Used	Not used
7	BUSY	A fault was declared because the device was busy and unable to respond.
6	OFF	This bit is asserted if the unit is not providing power to the output, regardless of the reason, including simply not being enabled.
5	VOUT_OV_FAULT	An output overvoltage fault has occurred.
4	IOUT_OC_FAULT	An output overcurrent fault has occurred.
3	VIN_UV_FAULT	An input undervoltage fault has occurred.
2	TEMPERATURE	A temperature fault or warning has occurred.
1	CML	A communications, memory or logic fault has occurred.
0	None of the above	A fault other than the faults listed in bits 7:1 above has occurred. The source of the fault will be in bits 15:8 of the STATUS_WORD

**NOTE:**15. If the POWER\_GOOD# bit is set, this indicates that the POWER\_GOOD signal, if present, is signaling that the output power is not good.

**STATUS\_VOUT (7Ah)**

Definition: The STATUS\_VOUT command returns one data byte with the status of the output voltage.

Paged or Global: Paged

Data Length in Bytes: 1

Data Format: Bit Field

Type: Read Only

Protectable: No

Default Value: 00h

Units: N/A

COMMAND	STATUS_VOUT (7Ah)							
Format	Bit Field							
Bit Position	7	6	5	4	3	2	1	0
Access	R	R	R	R	R	R	R	R
Function	See Following Table							
Default Value	0	0	0	0	0	0	0	0

BIT NUMBER	STATUS BIT NAME	MEANING
7	VOUT_OV_FAULT	Indicates an output overvoltage fault.
6	VOUT_OV_WARNING	Not used
5	VOUT_UV_WARNING	Not used
4	VOUT_UV_FAULT	Indicates an output undervoltage fault.
3:0	Not Used	Not used

**STATUS\_IOUT (7Bh)**

Definition: The STATUS\_IOUT command returns one data byte with the status of the output current.

Paged or Global: Paged

Data Length in Bytes: 1

Data Format: Bit Field

Type: Read Only

Protectable: No

Default Value: 00h

Units: N/A

COMMAND	STATUS_IOUT (7Bh)							
Format	Bit Field							
Bit Position	7	6	5	4	3	2	1	0
Access	R	R	R	R	R	R	R	R
Function	See Following Table							
Default Value	0	0	0	0	0	0	0	0

BIT NUMBER	STATUS BIT NAME	MEANING
7	IOUT_OC_FAULT	An output overcurrent fault has occurred.
6	Not Used	Not used
5	Not Used	Not used
4	IOUT_UC_FAULT	An output undercurrent fault has occurred.
3:0	Not Used	Not used

**STATUS\_INPUT (7Ch)**

Definition: The STATUS\_INPUT command returns input voltage and input current status information.

Paged or Global: Global

Data Length in Bytes: 1

Data Format: Bit Field

Type: Read-only

Protectable: No

Default Value: 00h

Units: N/A

COMMAND	STATUS_INPUT (7Ch)							
Format	Bit Field							
Bit Position	7	6	5	4	3	2	1	0
Access	R	R	R	R	R	R	R	R
Function	See Following Table							
Default Value	0	0	0	0	0	0	0	0

BIT NUMBER	STATUS BIT NAME	MEANING
7	VIN_OV_FAULT	An input overvoltage fault has occurred.
6	VIN_OV_WARNING	An input overvoltage warning has occurred.
5	VIN_UV_WARNING	An input undervoltage warning has occurred.
4	VIN_UV_FAULT	An input undervoltage fault has occurred.
3:0	Not Used	Not used

**STATUS\_TEMPERATURE (7Dh)**

Definition: The STATUS\_TEMPERATURE command returns one byte of information with a summary of any temperature related faults or warnings.

Paged or Global: Paged

Data Length in Bytes: 1

Data Format: Bit Field

Type: Read-only

Protectable: No

Default Value: 00h

Units: N/A

COMMAND	STATUS_TEMP (7Dh)							
Format	Bit Field							
Bit Position	7	6	5	4	3	2	1	0
Access	R	R	R	R	R	R	R	R
Function	See Following Table							
Default Value	0	0	0	0	0	0	0	0

BIT NUMBER	STATUS BIT NAME	MEANING
7	OT_FAULT	An over-temperature fault has occurred.
6	OT_WARNING	An over-temperature warning has occurred.
5	UT_WARNING	An under-temperature warning has occurred.
4	UT_FAULT	An under-temperature fault has occurred.
3:0	Not Used	Not used

**STATUS\_CML (7Eh)**

Definition: The STATUS\_WORD command returns one byte of information with a summary of any communications, logic and/or memory errors.

Paged or Global: Global

Data Length in Bytes: 1

Data Format: Bit Field

Type: Read Only

Protectable: No

Default Value: 00h

Units: N/A

COMMAND	STATUS_CML (7Eh)							
Format	Bit Field							
Bit Position	7	6	5	4	3	2	1	0
Access	R	R	R	R	R	R	R	R
Function	See Following Table							
Default Value	0	0	0	0	0	0	0	0

BIT NUMBER	MEANING
7	Invalid or unsupported Power Management bus command was received.
6	The Power Management bus command was sent with invalid or unsupported data.
5	A packet error was detected in the Power Management bus command.
4:2	Not used
1	A Power Management bus command tried to write to a read-only or protected command, or a communication fault other than the ones listed in this table has occurred.
0	Not used



**STATUS\_MFR\_SPECIFIC (80h)**

Definition: The STATUS\_MFR\_SPECIFIC command returns one byte of information providing the status of the device's voltage monitoring and clock synchronization faults.

Paged or Global: Global

Data Length in Bytes: 1

Data Format: Bit Field

Type: Read Only

Protectable: No

Default Value: 00h

Units: N/A

COMMAND	STATUS_MFR_SPECIFIC (80h)							
Format	Bit Field							
Bit Position	7	6	5	4	3	2	1	0
Access	R	R	R	R	R	R	R	R
Function	See Following Table							
Default Value	0	0	0	0	0	0	0	0

BIT	FIELD NAME	MEANING
7	Not Used	Not used
6	DDC Warning	An error was detected on the DDC bus.
5	VMON UV Warning	The voltage on the VMON pin has dropped 10% below the level set by MFR_VMON_UV_FAULT.
4	VMON OV Warning	The voltage on the VMON pin has risen 10% above the level set by MFR_VMON_OV_FAULT.
3	External Switching Period Fault	Loss of external clock synchronization has occurred.
2	Not Used	Not used
1	VMON UV Fault	The voltage on the VMON pin has dropped below the level set by MFR_VMON_UV_FAULT.
0	VMON OV Fault	The voltage on the VMON pin has risen above the level set by MFR_VMON_OV_FAULT.

**READ\_VIN (88h)**

Definition: Returns the input voltage reading.

Paged or Global: Global

Data Length in Bytes: 2

Data Format: Linear-11

Type: Read Only

Protectable: No

Default Value: N/A

Units: V

Equation:  $READ\_VIN = Y \times 2^N$

Range: N/A

COMMAND	READ_VIN (88h)															
Format	Linear-11															
Bit Position	15	14	13	12	11	10	9	8	7	6	5	4	3	2	1	0
Access	R	R	R	R	R	R	R	R	R	R	R	R	R	R	R	R
Function	Signed Exponent, N						Signed Mantissa, Y									
Default Value	N/A	N/A	N/A	N/A	N/A	N/A	N/A	N/A	N/A	N/A	N/A	N/A	N/A	N/A	N/A	N/A

### READ\_IIN (89h)

Definition: Returns the input current reading.

Paged or Global: Global

Data Length in Bytes: 2

Data Format: Linear-11

Type: Read Only

Protectable: No

Default Value: N/A

Units: A

Equation:  $READ\_IIN = Y \times 2^N$

Range: N/A

COMMAND	READ_IIN (89h)															
Format	Linear-11															
Bit Position	15	14	13	12	11	10	9	8	7	6	5	4	3	2	1	0
Access	R	R	R	R	R	R	R	R	R	R	R	R	R	R	R	R
Function	Signed Exponent, N						Signed Mantissa, Y									
Default Value	N/A	N/A	N/A	N/A	N/A	N/A	N/A	N/A	N/A	N/A	N/A	N/A	N/A	N/A	N/A	N/A



Asia-Pacific  
+86 755 298 85888

Europe, Middle East  
+353 61 225 977

North America  
+1 408 785 5200

**READ\_VOUT (8Bh)**

Definition: Returns the output voltage reading.

Paged or Global: Paged

Data Length in Bytes: 2

Data Format: Linear-16 Unsigned

Type: Read Only

Protectable: No

Default Value: N/A

Equation:  $READ\_VOUT = READ\_VOUT \times 2^{-13}$

Units: V

COMMAND	READ_VOUT (8Bh)															
Format	Linear-16 Unsigned															
Bit Position	15	14	13	12	11	10	9	8	7	6	5	4	3	2	1	0
Access	R	R	R	R	R	R	R	R	R	R	R	R	R	R	R	R
Default Value	N/A	N/A	N/A	N/A	N/A	N/A	N/A	N/A	N/A	N/A	N/A	N/A	N/A	N/A	N/A	N/A

**READ\_IOUT (8Ch)**

Definition: Returns the output current reading.

Paged or Global: Paged

Data Length in Bytes: 2

Data Format: Linear-11

Type: Read Only

Protectable: No

Default Value: N/A

Units: A

Equation:  $READ\_IOUT = Y \times 2^N$

Range: N/A

COMMAND	READ_IOUT (8Ch)															
Format	Linear-11															
Bit Position	15	14	13	12	11	10	9	8	7	6	5	4	3	2	1	0
Access	R	R	R	R	R	R	R	R	R	R	R	R	R	R	R	R
Function	Signed Exponent, N						Signed Mantissa, Y									
Default Value	N/A	N/A	N/A	N/A	N/A	N/A	N/A	N/A	N/A	N/A	N/A	N/A	N/A	N/A	N/A	N/A



### READ\_TEMPERATURE\_1 (8Dh)

Definition: Returns the temperature reading internal to the device.

Paged or Global: Global

Data Length in Bytes: 2

Data Format: Linear-11

Type: Read Only

Protectable: No

Default Value: N/A

Units: °C

Equation:  $READ\_TEMPERATURE\_1 = Y \times 2^N$

Range: N/A

COMMAND	READ_TEMPERATURE_1 (8Dh)															
Format	Linear-11															
Bit Position	15	14	13	12	11	10	9	8	7	6	5	4	3	2	1	0
Access	R	R	R	R	R	R	R	R	R	R	R	R	R	R	R	R
Function	Signed Exponent, N						Signed Mantissa, Y									
Default Value	N/A	N/A	N/A	N/A	N/A	N/A	N/A	N/A	N/A	N/A	N/A	N/A	N/A	N/A	N/A	N/A

### READ\_TEMPERATURE\_2 (8Eh)

Definition: Returns the temperature reading from the external temperature device connected to XTEMP.

Paged or Global: Paged

Data Length in Bytes: 2

Data Format: Linear-11

Type: Read Only

Protectable: No

Default Value: N/A

Units: °C

Equation:  $READ\_TEMPERATURE\_2 = Y \times 2^N$

Range: N/A

COMMAND	READ_TEMPERATURE_2 (8Eh)															
Format	Linear-11															
Bit Position	15	14	13	12	11	10	9	8	7	6	5	4	3	2	1	0
Access	R	R	R	R	R	R	R	R	R	R	R	R	R	R	R	R
Function	Signed Exponent, N						Signed Mantissa, Y									
Default Value	N/A	N/A	N/A	N/A	N/A	N/A	N/A	N/A	N/A	N/A	N/A	N/A	N/A	N/A	N/A	N/A



Asia-Pacific  
+86 755 298 85888

Europe, Middle East  
+353 61 225 977

North America  
+1 408 785 5200

**READ\_TEMPERATURE\_3 (8Fh)**

Definition: Returns the temperature reading from the VMON/TMON pin when the device is configured to read temperature on the VMON/TMON pin by setting bit 12 in the USER\_GLOBAL\_CONFIG command to 1. The voltage on the VMON/TMON pin is converted to °C by the equation  $TEMPERATURE\ 3 = (VMON\ voltage - 0.6V)/0.008$ . See MFR\_VMON commands starting on [page 85](#) (F5h, F6h, F8h, F9H) for fault limits when reading temperature on the VMON/TMON pin. When using the Intersil ISL9922X smart power stage, a 2:1 voltage divider is needed between the TMON pin of the ISL9922X and the VMON/TMON pin of the ZL8802.

Paged or Global: Global

Data Length in Bytes: 2

Data Format: Linear-11

Type: Read Only

Protectable: No

Default Value: N/A

Units: °C

Equation:  $READ\_TEMPERATURE\_3 = Y \times 2^N$

Range: N/A

COMMAND	READ_TEMPERATURE_3 (8Fh)															
Format	Linear-11															
Bit Position	15	14	13	12	11	10	9	8	7	6	5	4	3	2	1	0
Access	R	R	R	R	R	R	R	R	R	R	R	R	R	R	R	R
Function	Signed Exponent, N					Signed Mantissa, Y										
Default Value	N/A	N/A	N/A	N/A	N/A	N/A	N/A	N/A	N/A	N/A	N/A	N/A	N/A	N/A	N/A	N/A

**READ\_DUTY\_CYCLE (94h)**

Definition: Reports the actual duty cycle of the converter during the enable state.

Paged or Global: Paged

Data Length in Bytes: 2

Data Format: Linear-11

Type: Read Only

Protectable: No

Default Value: N/A

Units: %

Equation:  $READ\_DUTY\_CYCLE = Y \times 2^N$

Range: 0 to 100%

COMMAND	READ_DUTY_CYCLE (94h)															
Format	Linear-11															
Bit Position	15	14	13	12	11	10	9	8	7	6	5	4	3	2	1	0
Access	R	R	R	R	R	R	R	R	R	R	R	R	R	R	R	R
Function	Signed Exponent, N					Signed Mantissa, Y										
Default Value	N/A	N/A	N/A	N/A	N/A	N/A	N/A	N/A	N/A	N/A	N/A	N/A	N/A	N/A	N/A	N/A

**READ\_FREQUENCY (95h)**

Definition: Reports the actual switching frequency of the converter during the enable state.

Paged or Global: Global

Data Length in Bytes: 2

Data Format: Linear-11

Type: Read Only

Default Value: N/A

Units: kHz

Equation:  $READ\_FREQUENCY = Y \times 2^N$

Range: N/A

COMMAND	READ_FREQUENCY (95h)															
Format	Linear-11															
Bit Position	15	14	13	12	11	10	9	8	7	6	5	4	3	2	1	0
Access	R	R	R	R	R	R	R	R	R	R	R	R	R	R	R	R
Function	Signed Exponent, N					Signed Mantissa, Y										
Default Value	N/A	N/A	N/A	N/A	N/A	N/A	N/A	N/A	N/A	N/A	N/A	N/A	N/A	N/A	N/A	N/A

**POWER MANAGEMENT BUS\_REVISION (98h)**

Definition: The POWER MANAGEMENT BUS\_REVISION command returns the revision of the PBus Specification to which the device is compliant.

Data Length in Bytes: 1

Data Format: Bit Field

Type: Read Only

Protectable: N/A

Default Value: 22h (Part 1 Revision 1.2, Part 2 Revision 1.2)

Units: N/A

COMMAND	POWER MANAGEMENT BUS_REVISION (98h)								
Format	Bit Field								
Bit Position	7	6	5	4	3	2	1	0	
Access	R	R	R	R	R	R	R	R	
Function	See Following Table								
Default Value	0	0	1	0	0	0	1	0	

BITS 7:4	PART 1 REVISION	BITS 3:0	PART 2 REVISION
0000	1.0	0000	1.0
0001	1.1	0001	1.1



Asia-Pacific +86 755 298 85888 Europe, Middle East +353 61 225 977 North America +1 408 785 5200

0010	1.2	0010	1.2
------	-----	------	-----

**MFR\_ID (99h)**

Definition: MFR\_ID sets a user defined identification string not to exceed 32 bytes. The sum total of characters in MFR\_ID, MFR\_MODEL, MFR\_REVISION, MFR\_LOCATION, MFR\_DATE, MFR\_SERIAL and USER\_DATA\_00 plus one byte per command cannot exceed 128bytes. This limitation includes multiple writes of this command before a STORE command. To clear multiple writes, perform a RESTORE, write this command then perform a STORE/RESTORE.

Paged or Global: Global

Data Length in Bytes: User defined

Data Format: ASCII, ISO/IEC 8859-1

Type: Block R/W

Protectable: Yes

Default Value: Null

Units: N/A

**MFR\_MODEL (9Ah)**

Definition: MFR\_MODEL sets a user defined model string not to exceed 32 bytes. The sum total of characters in MFR\_ID, MFR\_MODEL, MFR\_REVISION, MFR\_LOCATION, MFR\_DATE, MFR\_SERIAL and USER\_DATA\_00 plus one byte per command cannot exceed 128bytes. This limitation includes multiple writes of this command before a STORE command. To clear multiple writes, perform a RESTORE, write this command then perform a STORE/RESTORE.

Paged or Global: Global

Data Length in Bytes: User defined

Data Format: ASCII, ISO/IEC 8859-1

Type: Block R/W

Protectable: Yes

Default Value: Null

Units: N/A

**MFR\_REVISION (9Bh)**

Definition: MFR\_REVISION sets a user defined revision string not to exceed 32 bytes. The sum total of characters in MFR\_ID, MFR\_MODEL, MFR\_REVISION, MFR\_LOCATION, MFR\_DATE, MFR\_SERIAL and USER\_DATA\_00 plus one byte per command cannot exceed 128bytes. This limitation includes multiple writes of this command before a STORE command. To clear multiple writes, perform a RESTORE, write this command then perform a STORE/RESTORE.

Paged or Global: Global

Data Length in Bytes: User defined

Data Format: ASCII, ISO/IEC 8859-1

Type: Block R/W

Protectable: Yes

Default Value: Null

Units: N/A

**MFR\_LOCATION (9Ch)**

Definition: MFR\_LOCATION sets a user defined location identifier string not to exceed 32 bytes. The sum total of characters in MFR\_ID, MFR\_MODEL, MFR\_REVISION, MFR\_LOCATION, MFR\_DATE, MFR\_SERIAL and USER\_DATA\_00 plus one byte per command cannot exceed 128bytes. This limitation includes multiple writes of this command before a STORE command. To clear multiple writes, perform a RESTORE, write this command then perform a STORE/RESTORE.

Paged or Global: Global

Data Length in Bytes: User defined

Data Format: ASCII. ISO/IEC 8859-1

Type: Block R/W

Protectable: Yes

Default Value: Null

Units: N/A

**MFR\_DATE (9Dh)**

Definition: MFR\_DATE sets a user defined date string not to exceed 32 bytes. The sum total of characters in MFR\_ID, MFR\_MODEL, MFR\_REVISION, MFR\_LOCATION, MFR\_DATE, MFR\_SERIAL and USER\_DATA\_00 plus one byte per command cannot exceed 128bytes. This limitation includes multiple writes of this command before a STORE command. To clear multiple writes, perform a RESTORE, write this command then perform a STORE/RESTORE.

Paged or Global: Global

Data Length in Bytes: User defined

Data Format: ASCII. ISO/IEC 8859-1

Type: Block R/W

Protectable: Yes

Default Value: Null

Units: N/A

**MFR\_SERIAL (9Eh)**

Definition: MFR\_SERIAL sets a user defined serialized identifier string not to exceed 32 bytes. The sum total of characters in MFR\_ID, MFR\_MODEL, MFR\_REVISION, MFR\_LOCATION, MFR\_DATE, MFR\_SERIAL and USER\_DATA\_00 plus one byte per command cannot exceed 128bytes. This limitation includes multiple writes of this command before a STORE command. To clear multiple writes, perform a RESTORE, write this command then perform a STORE/RESTORE.

Paged or Global: Global

Data Length in Bytes: User defined

Data Format: ASCII. ISO/IEC 8859-1

Type: Block R/W

Protectable: Yes

Default Value: Null

Units: N/A

### IC\_DEVICE\_ID (ADh)

Definition: Reports device identification information.

Data Length in Bytes: 4

Data Format: CUS

Type: Block Read

Protectable: No

Default Value: 49A02D00h (ZL8802)

Units: N/A

COMMAND	IC_DEVICE_ID (ADh)			
Format	Block Read			
Byte Position	3	2	1	0
Function	MFR code	ID High Byte	ID Low Byte	Reserved
Default Value	49h	A0h	2Ah	00h

### IC\_DEVICE\_REV (AEh)

Definition: Reports device revision information.

Data Length in Bytes: 4

Data Format: CUS

Type: Block Read

Protectable: No

Default Value: 01000000h (initial release)

Units: N/A

COMMAND	IC_DEVICE_REV (AEh)			
Format	Block Read			
Byte Position	3	2	1	0
Function	Firmware Major	Firmware Minor	Factory Configuration	Reserved
Default Value	01h	00h	00h	00h

### USER\_DATA\_00 (B0h)

Definition: USER\_DATA\_00 sets a user defined data string not to exceed 32 bytes. The sum total of characters in MFR\_ID, MFR\_MODEL, MFR\_REVISION, MFR\_LOCATION, MFR\_DATE, MFR\_SERIAL and USER\_DATA\_00 plus one byte per command cannot exceed 128bytes This limitation includes multiple writes of this command before a STORE command. To clear multiple writes, perform a RESTORE, write this command then perform a STORE/RESTORE.

Paged or Global: Global

Data Length in Bytes: User defined

Data Format: ASCII. ISO/IEC 8859-1

Type: Block R/W

Protectable: Yes

Default Value: Null

Units: N/A



Asia-Pacific  
+86 755 298 85888

Europe, Middle East  
+353 61 225 977

North America  
+1 408 785 5200

**MIN\_VOUT\_REG (CEh)**

Definition: Sets the minimum output voltage in millivolts (mV) that the device will attempt to regulate to during start-up and shutdown ramps.

Paged or Global: Paged

Data Length in Bytes: 2

Data Format: Linear-11

Type: R/W

Protectable: Yes

Default Value: 0000h (0mV)

Units: A

Equation:  $MIN\_VOUT\_REG = Y \times 2^N$

COMMAND	MIN_VOUT_REG (CEh)															
Format	Linear-11															
Bit Position	15	14	13	12	11	10	9	8	7	6	5	4	3	2	1	0
Access	R/W	R/W	R/W	R/W	R/W	R/W	R/W	R/W	R/W	R/W	R/W	R/W	R/W	R/W	R/W	R/W
Function	Signed Exponent, N						Signed Mantissa, Y									
Default Value	1	1	1	1	0	0	1	0	0	1	0	1	1	0	0	0

**ISENSE\_CONFIG (D0h)**

Definition: Configures current sense circuitry.

Paged or Global: Paged

Data Length in Bytes: 2

Data Format: Bit Field

Type: R/W word

Protectable: Yes

Default Value: 620Eh (384ns blanking, SPS sensing, high range)

Units: N/A

Range: N/A

COMMAND	ISENSE_CONFIG (D0h)															
Format	Bit Field															
Bit Position	15	14	13	12	11	10	9	8	7	6	5	4	3	2	1	0
Access	R/W	R/W	R/W	R/W	R/W	R/W	R/W	R/W	R/W	R/W	R/W	R/W	R/W	R/W	R/W	R/W
Function	See Following Table															
Default Value	0	1	1	0	0	0	1	0	0	0	0	0	1	1	1	0



**ISENSE\_CONFIG (D0h)**

BIT	FIELD NAME	VALUE	SETTING	DESCRIPTION
15:11	Current Sense Blanking Time	00000	0	Sets the blanking time current sense blanking time in increments of 32ns
		00001	32	
		00010	64	
		00011	96	
		00100	128	
		00101	160	
		00110	192	
		00111	224	
		01000	256	
		01001	288	
		01010	320	
		01011	352	
		01100	384	
		01101	416	
		01110	448	
		01111	480	
		10000	512	
		10001	544	
10010	576			
10011	608			
10100	640			
10101	672			
10110	704			
10111	736			
11000	768			
11001	800			
11010	832			
10:8	Current Sense Fault Count	000	1	Sets the number of consecutive overcurrent (OC) or undercurrent (UC) events required for a fault. An event can occur once during each switching cycle. For example, if 5 is selected, an OC or UC event must occur for 5 consecutive switching cycles, resulting in a delay of at least 5 switching periods.
		001	3	
		010	5	
		011	7	
10:8	Current Sense Fault Count	100	9	Sets the number of consecutive overcurrent (OC) or undercurrent (UC) events required for a fault. An event can occur once during each switching cycle. For example, if 5 is selected, an OC or UC event must occur for 5 consecutive switching cycles, resulting in a delay of at least 5 switching periods.
		101	11	
		110	13	
		111	15	
7:4	Not Used	0000	Not Used	Not used
3:2	Current Sense Control	00	Not Used	Selection of current sensing method (SPS IMON)
		01	DCR (Down Slope)	
		10	DCR (Up Slope)	
		11	SPS	
1:0	Current Sense Range	00	Low Range	Low range $\pm 25\text{mV}$ , medium range $\pm 35\text{mV}$ , high range $\pm 50\text{mV}$
		01	Medium Range	
		10	High Range	
		11	Not Used	

**USER\_CONFIG (D1h)**

Definition: Configures several user-level features. This command should be saved immediately after being written to the desired user or default store. This is recommended when written as an individual command or as part of a series of commands in a configuration file or script.

Paged or Global: Paged

Data Length in Bytes: 2

Data Format: Bit Field

Type: R/W

Protectable: Yes

Default Value: Set by CFG pin-strap setting

Units: N/A

COMMAND	USER_CONFIG (D1h)															
Format	Bit Field															
Bit Position	15	14	13	12	11	10	9	8	7	6	5	4	3	2	1	0
Access	R/W	R/W	R/W	R/W	R/W	R/W	R/W	R/W	R/W	R/W	R/W	R/W	R/W	R/W	R/W	R/W
Function	See Following Table															
Default Value	CFG Pin-strap Setting															

**USER\_CONFIG (D1h)**

BIT	FIELD NAME	VALUE	SETTING	DESCRIPTION
15:11	Minimum Duty Cycle	00000	0-31d	Sets the minimum duty-cycle to $2X(VALUE+1)/512$ . Must be enabled with Bit 7
10	Not Used	1	Not Used	Not used
9:8	Not Used	00	Not Used	Not used
7	Minimum Duty Cycle Control	0	Disable	Control for minimum duty cycle
		1	Enable	
6	Not Used	0	Not Used	Not used
5	VSET Select	0	VSET0	0 = Uses only VSET0 to set the pin-strapped output voltage
		1	VSET1	1 = Uses only VSET1 to set the pin-strapped output voltage
4	Not Used	0	Not Used	Not used
3	PWML disabled state	0	Low when disabled	PWML is low (off) when device is disabled (bit 3 set to 0), or high (on) when device is disabled (bit 3 set to 1)
		1	High when disabled	
2	Power-good Configuration	0	Open Drain	0 = PG is open-drain output
		1	Push-Pull	1 = PG is push-pull output
1	XTEMP Enable	0	Disable	Enable external temperature sensor
		1	Enable	
0	XTEMP Fault Select	0	Disable	Selects external temperature sensor to determine temperature faults

### IIN\_CAL\_GAIN (D2h)

Definition: Sets the effective impedance across the current sense circuit for use in calculating input current at +25°C.

Paged or Global: Global

Data Length in Bytes: 2

Data Format: Linear-11

Type: R/W

Protectable: Yes

Default Value: C200h (2mΩ)

Units: mΩ

Equation:  $IIN\_CAL\_GAIN = Y \times 2^N$

COMMAND	IIN_CAL_GAIN (D2h)															
Format	Linear-11															
Bit Position	15	14	13	12	11	10	9	8	7	6	5	4	3	2	1	0
Access	R/W	R/W	R/W	R/W	R/W	R/W	R/W	R/W	R/W	R/W	R/W	R/W	R/W	R/W	R/W	R/W
Function	Signed Exponent, N					Signed Mantissa, Y										
Default Value	1	1	0	0	0	0	1	0	0	0	0	0	0	0	0	0

### DDC\_CONFIG (D3h)

Definition: Configures DDC addressing and current sharing for up to 8 phases. To operate as a 2-phase controller, set both phases to the same rail ID, set phases in rail to 2, then set each phase ID sequentially as 0 and 1. To operate as a 4-phase controller, set all phases to the same rail ID, set phases in rail to 4, then set each phase ID alternately, for example, the first ZL8802 will be set to 0 and 2, the second ZL8802 will be set to 1 and 3. The ZL8802 will automatically equally offset the phases in the rail. Phase spreading is done automatically as part of the DDC\_CONFIG command. When using CFG pin-strap settings, the DDC\_CONFIG command is set automatically.

**NOTE:** The output MUST be connected to VSEN0P and VSEN0N when operating as a 2-phase controller.

Paged or Global: Paged

Data Length in Bytes: 2

Data Format: Bit Field

Type: R/W

Protectable: Yes

Default Value: Power Management bus address pin-strap dependent.

Units: N/A

COMMAND	DDC_CONFIG (D3h)															
Format	Bit Field															
Bit Position	15	14	13	12	11	10	9	8	7	6	5	4	3	2	1	0
Access	R/W	R/W	R/W	R/W	R/W	R/W	R/W	R/W	R/W	R/W	R/W	R/W	R/W	R/W	R/W	R/W
Function	See Following Table															
Default Value	0	0	0	Lower 5 bits of device address			0	0	0	0	0	0	0	0	0	0

BIT	FIELD NAME	VALUE	SETTING	DESCRIPTION
15:13	Phase ID	0 to 7	0	Sets the output's phase position within the rail
12:8	Rail ID	0 to 31d	0	Identifies the device as part of a current sharing rail (Shared output)
7:3	Not Used	00	00	Not used



Asia-Pacific  
+86 755 298 85888

Europe, Middle East  
+353 61 225 977

North America  
+1 408 785 5200

2:0	Phases In Rail	0 to 7	0	Identifies the number of phases on the same rail (+1)
-----	----------------	--------	---	---

**POWER\_GOOD\_DELAY (D4h)**

Definition: Sets the delay applied between the output exceeding the PG threshold (POWER\_GOOD\_ON) and asserting the PG pin. The delay time can range from 0ms up to 500ms, in steps of 125ns. A 1ms minimum configured value is recommended to apply proper debounce to this signal.

Paged or Global: Paged

Data Length in Bytes: 2

Data Format: Linear-11

Type: R/W

Protectable: Yes

Default Value: BA00h, 1ms

Units: ms

Equation:  $POWER\_GOOD\_DELAY = Y \times 2^N$

Range: 0 to 500ms

COMMAND	POWER_GOOD_DELAY (D4h)															
Format	Linear-11															
Bit Position	15	14	13	12	11	10	9	8	7	6	5	4	3	2	1	0
Access	R/W	R/W	R/W	R/W	R/W	R/W	R/W	R/W	R/W	R/W	R/W	R/W	R/W	R/W	R/W	R/W
Function	Signed Exponent, N					Signed Mantissa, Y										
Default Value	1	0	1	1	1	0	1	0	0	0	0	0	0	0	0	0

**MULTI\_PHASE\_RAMP\_GAIN (D5h)**

Definition: MULTI\_PHASE\_RAMP\_GAIN command value indirectly determines the output voltage rise time during the turn-on ramp. Typical gain values range from 1 to 10. Lower gain values produce longer ramp times.

MULTI\_PHASE\_RAMP\_GAIN mode is automatically selected when the ZLS8802 is configured to operate in a 4-phase current sharing group. When in MULTI\_PHASE\_RAMP\_GAIN mode, the turn-on ramp up is done with the high bandwidth ASCR control circuitry disabled, resulting in a lower loop bandwidth during start-up ramps. Once POWER\_GOOD has been asserted, ASCR circuitry is enabled and the ZLS8802 operates normally. When MULTI\_PHASE\_RAMP\_GAIN mode is enabled, soft-off ramps are not allowed (TOFF\_FALL is ignored). When the ZL8802 is commanded to shut down, the PWMHO/1 output is tri-stated, turning both the high-side and low-side MOSFETs off, and the PWML0/1 pin is pulled low (DrMOS disabled). Large load current transitions during multiphase ramp-ups will cause output voltage discontinuities.

When the phase count is 2; i.e., when the ZL8802 is operating standalone, ASCR is enabled at all times and all commands associated with turn-on and turn-off (TON\_RISE, TOFF\_FALL, Soft-Off) operate normally.

Rise time can be calculated using [Equation:](#)

Rise time =  $VOUT\_COMMAND / \{14 \bullet \text{Input Voltage} \bullet \text{FREQUENCY\_SWITCH (in MHz)} \bullet \text{MULTI\_PHASE\_RAMP\_GAIN}\}$

Paged or Global: Global

Data Length in Bytes: 1

Data Format: Custom

Type: R/W

Protectable: Yes

Default Value: 03h

Units: N/A

COMMAND	MULTI_PHASE_RAMP_GAIN (D5h)							
Format	1 Byte Binary							
Bit Position	7	6	5	4	3	2	1	0
Access	R/W	R/W	R/W	R/W	R/W	R/W	R/W	R/W
Default Value	0	0	0	0	0	0	1	1

BIT	FIELD NAME	VALUE	DESCRIPTION
7:0	Gain	00-FF	Start-up ramp gain

**INDUCTOR (D6h)**

Definition: Informs the device of the circuit’s inductor value. This is used in adaptive algorithm calculations relating to the inductor ripple current.

Paged or Global: Paged

Data Length in Bytes: 2

Data Format: Linear-11

Type: R/W

Protectable: Yes

Default Value: B133h (0.3µH)

Units: µH

Equation:  $INDUCTOR = Y \times 2^N$

Range: 0 to 100µH

COMMAND	INDUCTOR (D6h)															
Format	Linear-11															
Bit Position	15	14	13	12	11	10	9	8	7	6	5	4	3	2	1	0
Access	R/W	R/W	R/W	R/W	R/W	R/W	R/W	R/W	R/W	R/W	R/W	R/W	R/W	R/W	R/W	R/W
Function	Signed Exponent, N						Signed Mantissa, Y									
Default Value	1	0	1	1	0	0	0	1	0	0	1	1	0	0	1	1

**SNAPSHOT\_FAULT\_MASK (D7h)**

Definition: Prevents faults from causing a SNAPSHOT event (and store) from occurring.

Data Length in Bytes: 2

Data Format: BIT

Type: R/W

Protectable: Yes

Default Value: 0000h

Units: NA

Range: NA



COMMAND	SNAPSHOT_FAULT_MASK (D7h)															
Format	Bit Field															
Bit Position	15	14	13	12	11	10	9	8	7	6	5	4	3	2	1	0
Access	R	R	R	R	R	R	R	R	R	R	R	R	R	R	R	R
Function	See Following Table															
Default Value	0	0	0	0	0	0	0	0	0	0	0	0	0	0	0	0

BIT NUMBER	STATUS BIT NAME	MEANING
15:14	Not Used	Not used
13	Group	Ignore Fault Spreading faults
12	Phase	Ignore Other Phase faults
11	CPU	Ignore CPU faults
10	CRC	Ignore CRC Memory faults
9	Not Used	Not used
8	Not Used	Not used
7	IOUT_UC_FAULT	Ignore output undercurrent faults
6	IOUT_OC_FAULT	Ignore output overcurrent faults
5	VIN_UV_FAULT	Ignore input undervoltage faults
4	VIN_OV_FAULT	Ignore Input undervoltage faults
3	UT_FAULT	Ignore under-temperature faults
2	OT_FAULT	Ignore over-temperature faults
1	VOUT_UV_FAULT	Ignore output undervoltage faults
0	VOUT_OV_FAULT	Ignore output overvoltage faults

**OVUV\_CONFIG (D8h)**

Definition: Configures the output voltage OV and UV fault detection feature

Paged or Global: Paged

Data Length in Bytes: 1

Data Format: Bit Field

Type: R/W

Protectable: Yes

Default Value: 00h

Units: N/A

COMMAND	OVUV_CONFIG (D8h)							
Format	Bit Field							
Bit Position	7	6	5	4	3	2	1	0

Access	R/W	R/W	R/W	R/W	R/W	R/W	R/W	R/W
Function	See Following Table							
Default Value	0	0	0	0	0	0	0	0

BITS	PURPOSE	VALUE	DESCRIPTION
7	Controls how an OV fault response shutdown sets the output driver state	0	An OV fault does not enable low-side power device
		1	An OV fault enables the low-side power device
6:4	Not Used	0	Not used
3:0	Defines the number of consecutive limit violations required to declare an OV or UV fault	N	N+1 consecutive OV or UV violations initiate a fault response

**XTEMP\_SCALE (D9h)**

Definition: Sets a scalar value that is used for calibrating the external temperature. The constant is applied in the equation below to produce the read value of XTEMP via the Power Management bus command READ\_TEMPERATURE\_2.

Paged or Global: Paged

Data Length in Bytes: 2

Data Format: Linear-11

Type: R/W

Protectable: Yes

Default Value: BA00h (1.0)

Units: 1/°C

**Equation:**  $READ\_TEMPERATURE\_2 = \left( ExternalTemperature \cdot \frac{1}{XTEMP\_SCALE} \right) + XTEMP\_OFFSET$

Range: 0.1 to 10

COMMAND	XTEMP_SCALE (D9h)															
Format	Linear-11															
Bit Position	15	14	13	12	11	10	9	8	7	6	5	4	3	2	1	0
Access	R/W	R/W	R/W	R/W	R/W	R/W	R/W	R/W	R/W	R/W	R/W	R/W	R/W	R/W	R/W	R/W
Function	Signed Exponent, N						Signed Mantissa, Y									
Default Value	1	0	1	1	1	0	1	0	0	0	0	0	0	0	0	0

**XTEMP\_OFFSET (DAh)**

Definition: Sets an offset value that is used for calibrating the external temperature. The constant is applied in the equation below to produce the read value of XTEMP via the Power Management bus command READ\_TEMPERATURE\_2.

Paged or Global: Paged

Data Length in Bytes: 2

Data Format: Linear-11

Type: R/W

Protectable: Yes

Default Value: 0000h (0)

Units: °C



$$\text{Equation: } \text{READ\_TEMPERATURE\_2} = \left( \text{ExternalTemperature} \cdot \frac{1}{\text{XTEMP\_SCALE}} \right) + \text{XTEMP\_OFFSET}$$

Range: -100°C to 100°C

COMMAND	XTEMP_OFFSET (DAh)															
Format	Linear-11															
Bit Position	15	14	13	12	11	10	9	8	7	6	5	4	3	2	1	0
Access	R/W	R/W	R/W	R/W	R/W	R/W	R/W	R/W	R/W	R/W	R/W	R/W	R/W	R/W	R/W	R/W
Function	Signed Exponent, N						Signed Mantissa, Y									
Default Value	0	0	0	0	0	0	0	0	0	0	0	0	0	0	0	0

#### MFR\_SMBALERT\_MASK (DBh)

Definition: The MFR\_SMBALERT\_MASK command is used to prevent faults from activating the SALRT pin. The bits in each byte correspond to a specific fault type as defined in the STATUS command.

Data Length in Bytes: 7

Data Format: Bit Field

Type: R/W

Protectable: Yes

Default Value: 00 00 00 00 00 00 00h (No faults masked)

Units: N/A

COMMAND	MFR_SMBALERT_MASK (DBh)							
Format	Bit Field							
Access	R/W	R/W	R/W	R/W	R/W	R/W	R/W	R/W
Function	See following table							
Bit Position	55	54	53	52	51	50	49	48
Default Value Byte 6	0	0	0	0	0	0	0	0
Bit Position	47	46	45	44	43	42	41	40
Default Value Byte 5	0	0	0	0	0	0	0	0
Bit Position	39	38	37	36	35	34	33	32
Default Value Byte 4	0	0	0	0	0	0	0	0
Bit Position	31	30	29	28	27	26	25	24
Default Value Byte 3	0	0	0	0	0	0	0	0
Bit Position	23	22	21	20	19	18	17	16
Default Value Byte 2	0	0	0	0	0	0	0	0
Bit Position	15	14	13	12	11	10	9	8
Default Value Byte 1	0	0	0	0	0	0	0	0
Bit Position	7	6	5	4	3	2	1	0
Default Value Byte 0	0	0	0	0	0	0	0	0



**MFR\_SMBALERT\_MASK (DBh)**

BYTE	STATUS BYTE NAME	MEANING
6	STATUS_MFR_SPECIFIC	Mask manufacturer specific faults as identified in the STATUS_MFR_SPECIFIC byte.
5	STATUS_OTHER	Not used
4	STATUS_CML	Mask communications, memory or logic specific faults as identified in the STATUS_CML byte.
3	STATUS_TEMPERATURE	Mask temperature specific faults as identified in the STATUS_TEMPERATURE byte
2	STATUS_INPUT	Mask input specific faults as identified in the STATUS_INPUT byte
1	STATUS_IOUT	Mask output current specific faults as identified in the STATUS_IOUT byte
0	STATUS_VOUT	Mask output voltage specific faults as identified in the STATUS_VOUT byte

**TEMPCO\_CONFIG (DCh)**

Definition: Configures the correction factor and temperature measurement source when performing temperature coefficient correction for current sense. TEMPCO\_CONFIG values are applied as negative correction to a positive temperature coefficient. TEMPCO\_CONFIG should be set to 3900ppm (27h) when using inductor DCR current sensing in order to compensate for the variation in inductor resistance due to the temperature coefficient of copper. When using the ISL9922X Smart Power Stage, TEMPCO\_CONFIG should be set to 0ppm (00h) since the IMON signal from the ISL9922X is internally compensated for temperature.

Paged or Global: Paged

Data Length in Bytes: 1

Data Format: Bit Field

Type: R/W

Protectable: Yes

Default Value: 00h (0ppm/°C, copper)

Equation: To determine the hex value of the Tempco Correction factor (TC) for current scale of a power stage current sensing, first determine the temperature coefficient of resistance for the sensing element, a. This is found with [Equation:](#)

$$\alpha = \frac{R_{REF} - R}{R_{REF} (T_{REF} - T)}$$

Where:

R = Sensing element resistance at temperature "T"

R<sub>REF</sub> = Sensing element resistance at reference temperature T<sub>REF</sub>

a = Temperature coefficient of resistance for the sensing element material

T = Temperature measured by temperature sensor, in degrees Celsius

T<sub>REF</sub> = Reference temperature that a is specified at for the sensing element material

After a is determined, convert the value in units of 100ppm/°C. This value is then converted to a hex value with [Equation:](#)

$$TC = \frac{a \times 10^6}{100}$$

Range: 0 to 12700ppm/°C

COMMAND	TEMPCO_CONFIG (DCh)							
Format	Bit Field							
Bit Position	7	6	5	4	3	2	1	0
Access	R/W	R/W	R/W	R/W	R/W	R/W	R/W	R/W
Function	See Following Table							
Default Value	0	0	0	0	0	0	0	0

BITS	PURPOSE	VALUE	DESCRIPTION
7	Selects the temp sensor source for tempco correction	0	Selects the internal temperature sensor
		1	Selects the XTEMP pin for temperature measurements (2N3904 Junction) Note that XTEMP must be enabled in USER_CONFIG, bit 1.
6:0	Sets the tempco correction in units of 100ppm/°C for IOOUT_CAL_GAIN	TC	$RSEN (DCR) = IOOUT\_CAL\_GAIN \times (1 + TC \times (T - 25))$ Where RSEN = resistance of sense element

### PINSTRAP\_READ\_STATUS (DDh)

Definition: Reads back 7 bytes of 8 bit values that represent the pin-strap settings of each of the device's pin-strap pins. This value corresponds to a resistor value, a high, a low or an open condition. The pin decode values correspond to pin-strap settings according to [Table](#):

TABLE.

R (kfi)	DECODE	R (kfi)	DECODE
10	00	51.1	11
11	01	56.2	12
12.1	02	61.9	13
13.3	03	68.1	14
14.7	04	75	15
16.2	05	82.5	16
17.8	06	90.9	17
19.6	07	100	18
21.5	08	110	19
23.7	09	121	1A
26.1	0A	133	1B
28.7	0B	147	1C
31.6	0C	162	1D
34.8	0D	178	1E
38.3	0E	LOW	F1
42.2	0F	OPEN	F2
46.4	10	HIGH	F3
Unmeasured			F4

Paged or Global: Global

Data Length in Bytes: 7

Data Format: Bit Field

Type: Read Only

Protectable: Yes

Default Value: Pin-strap settings

Units: N/A



**PINSTRAP\_READ\_STATUS (DDh)**

COMMAND	READ_PINSTRAP (DDh)															
Format	Bit Field															
Bit Position									55	54	53	52	51	50	49	48
Access									R	R	R	R	R	R	R	R
Function									ASCRCFG Pin Decode							
Default Value									ASCRCFG Pin-strap Setting							
Format	Bit Field															
Bit Position	47	46	45	44	43	42	41	40	39	38	37	36	35	34	33	32
Access	R	R	R	R	R	R	R	R	R	R	R	R	R	R	R	R
Function	CFG Pin Decode								SYNC Pin Decode							
Default Value	CFG Pin-strap Setting								SYNC Pin-strap Setting							
Format	Bit Field															

COMMAND	READ_PINSTRAP (DDh) (Continued)															
Bit Position	31	30	29	28	27	26	25	24	23	22	21	20	19	18	17	16
Access	R	R	R	R	R	R	R	R	R	R	R	R	R	R	R	R
Function	UVLO Pin Decode								VSET0 Pin Decode							
Default Value	UVLO Pin-strap Setting								VSET0 Pin-strap Setting							
Format	Bit Field															
Bit Position	15	14	13	12	11	10	9	8	7	6	5	4	3	2	1	0
Access	R	R	R	R	R	R	R	R	R	R	R	R	R	R	R	R
Function	VSET1 Pin Decode								Reserved							
Default Value	VSET1 Pin-strap Setting								N/A							

**PINSTRAP\_READ\_STATUS (DDh)**

BITS	PURPOSE	VALUE	DESCRIPTION
55:48	ASCRCFG Pin Decode	00-F4h	Decode value of ASCRCFG pin-strap setting
47:40	CFG Pin Decode	00-F4h	Decode value of CFG pin-strap setting
39:32	SYNC Pin Decode	00-F4h	Decode value of SYNC pin-strap setting
31:24	UVLO Pin Decode	00-F4h	Decode value of UVLO pin-strap setting
23:16	VSET0 Pin Decode	00-F4h	Decode value of VSET0 pin-strap setting
15:8	VSET1 Pin Decode	00-F4h	Decode value of VSET1 pin-strap setting
7:0	Not Used	FF	Not used



Asia-Pacific  
+86 755 298 85888

Europe, Middle East  
+353 61 225 977

North America  
+1 408 785 5200

**ASCR\_CONFIG (DFh)**

Definition: Allows user configuration of ASCR settings. ASCR gain and residual value are automatically set by the ZL8802 based on input voltage and output voltage. ASCR gain is analogous to bandwidth, ASCR residual is analogous to damping. To improve load transient response performance, increase ASCR gain. To lower transient response overshoot, increase ASCR residual. Increasing ASCR gain can result in increased PWM jitter and should be evaluated in the application circuit. Excessive ASCR gain can lead to excessive output voltage ripple. Increasing ASCR residual to improve transient response damping can result in slower recovery times, but will not affect the peak output voltage deviation. Typical ASCR gain settings range from 100 to 1000, and ASCR residual settings range from 10 to 90.

Paged or Global: Paged

Data Length in Bytes: 4

Data Format: Bit Field and unsigned binary

Type: R/W

Protectable: Yes

Default Value: ASCRCFG pin-strap setting

Units: N/A

COMMAND	ASCR_CONFIG (DFh)															
Format	Bit Field/Linear-8 Unsigned															
Bit Position	31	30	29	28	27	26	25	24	23	22	21	20	19	18	17	16
Access	R/W	R/W	R/W	R/W	R/W	R/W	R/W	R/W	R/W	R/W	R/W	R/W	R/W	R/W	R/W	R/W
Function	See Following Table															
Default Value	0	0	0	0	0	0	0	1	ASCRCFG Pin-strap Setting (residual)							
Format	Linear-16 Unsigned															
Bit Position	15	14	13	12	11	10	9	8	7	6	5	4	3	2	1	0
Access	R/W	R/W	R/W	R/W	R/W	R/W	R/W	R/W	R/W	R/W	R/W	R/W	R/W	R/W	R/W	R/W
Function	See Following Table															
Default Value	ASCRCFG Pin-strap Setting (gain)															

BITS	PURPOSE	VALUE	DESCRIPTION
31:25	Not Used	0000000h	Not used
24	ASCR Enable	1	Enable
		0	Disable
23:16	ASCR Residual Setting	0 - 7Fh	ASCR residual
15:0	ASCR Gain Setting	0-FFh	ASCR gain

**SEQUENCE (E0h)**

Definition: Identifies the Rail DDC ID of the prequel and sequel rails when performing multi-rail sequencing. The device will enable its output when its EN or OPERATION enable state, as defined by ON\_OFF\_CONFIG, is set and the prequel device has issued a power-good event on the DDC bus as a result of the prequel's Power-good (PG) signal going high. The device will disable its output (using the programmed delay values) when the sequel device has issued a power-down event on the DDC bus at the completion of its ramp-down (its output voltage is 0V).

The data field is a two-byte value. The most-significant byte contains the 5-bit Rail DDC ID of the prequel device. The least-significant byte contains the 5-bit Rail DDC ID of the sequel device. The most significant bit of each byte contains the enable of the prequel or sequel mode. This command overrides the corresponding sequence configuration set by the CONFIG pin settings.

Paged or Global: Paged

Data Length in Bytes: 2

Data Format: Bit Field

Type: R/W

Protectable: Yes

Default Value: 00h (prequel and sequel disabled)

Units: N/A

COMMAND	SEQUENCE (E0h)															
Format	Bit Field															
Bit Position	15	14	13	12	11	10	9	8	7	6	5	4	3	2	1	0
Access	R/W	R/W	R/W	R/W	R/W	R/W	R/W	R/W	R/W	R/W	R/W	R/W	R/W	R/W	R/W	R/W
Function	See Following Table															
Default Value	0	0	0	0	0	0	0	0	0	0	0	0	0	0	0	0

BIT	FIELD NAME	VALUE	SETTING	DESCRIPTION
15	Prequel Enable	0	Disable	Disable, no prequel preceding this rail
		1	Enable	Enable, prequel to this rail is defined by bits 12:8
14:13	Not Used	0	Not Used	Not used
12:8	Prequel Rail DDC ID	0-31d	DDC ID	Set to the DDC ID of the prequel rail
7	Sequel Enable	0	Disable	Disable, no sequel following this rail
		1	Enable	Enable, sequel to this rail is defined by bits 4:0
6:5	Not Used	0	Not Used	Not used
4:0	Sequel Rail DDC ID	0-31d	DDC ID	Set to the DDC ID of the sequel rail



Asia-Pacific  
+86 755 298 85888

Europe, Middle East  
+353 61 225 977

North America  
+1 408 785 5200

**TRACK\_CONFIG (E1h)**

Definition: Configures the voltage tracking modes of the device. Single device (Channel 0, Channel 1 or 2-phase) tracking is supported. Tracking as part of a 4-, 6- or 8-phase current sharing group is not supported. When tracking, the TOFF\_DELAY in the tracking device must be greater than TOFF\_DELAY + TOFF\_FALL in the device being tracked. When configured to track, VOUT\_COMMAND must be set to the desired steady state output voltage.

Data Length in Bytes: 1

Data Format: Bit Field

Type: R/W

Protectable: Yes

Default Value: 00h

Units: N/A

COMMAND	TRACK_CONFIG (E1h)							
Format	Bit Field							
Bit Position	7	6	5	4	3	2	1	0
Access	R/W	R/W	R/W	R/W	R/W	R/W	R/W	R/W
Function	See Following Table							
Default Value	0	0	0	0	0	0	0	0

BIT	FIELD NAME	VALUE	SETTING	DESCRIPTION
7	Voltage Tracking Control	0	Disable	Tracking is Disabled.
		1	Enable	Tracking is Enabled.
6:3	Not Used	0000	Not Used	Not used
2	Tracking Ratio Control	0	100%	Output Tracks at 100% ratio of VTRK input.
		1	50%	Output Tracks at 50% ratio of VTRK input.
1	Tracking Upper Limit	0	Target Voltage	Output Voltage is Limited by Target Voltage.
		1	VTRK Voltage	Output Voltage is Limited by VTRK Voltage.
0	Not Used	0	Not Used	Not used

**DDC\_GROUP (E2h)**

Definition: Rails (output voltages) are assigned Group numbers in order to share specified behaviors. The DDC\_GROUP command configures fault spreading group ID and enable, broadcast OPERATION group ID and enable, and broadcast VOUT\_COMMAND group ID and enable. Note that DDC Groups are separate and unique from DDC Rail IDs (see “[DDC\\_CONFIG \(D3h\)](#)”). Current sharing rails need to be in the same DDC Group in order to respond to broadcast VOUT\_COMMAND and OPERATION commands. Power fail event responses (and phases) are automatically spread in Phase 0 and 1 when the ZL8802 is operating in 2-phase current sharing mode when it is configured using DDC\_CONFIG, regardless of its setting in DDC\_GROUP.

Paged or Global: Paged

Data Length in Bytes: 34

Data Format: Bit Field

Type: R/W

Protectable: Yes

Default Value: Set by CFG pin-strap setting

Units: N/A

COMMAND	DDC_GROUP (E2h)															
Format	Bit Field															
Bit Position	31	30	29	28	27	26	25	24	23	22	21	20	19	18	17	16
Access	R/W	R/W	R/W	R/W	R/W	R/W	R/W	R/W	R/W	R/W	R/W	R/W	R/W	R/W	R/W	R/W
Function	Not Used											EN>	VOUT_COMMAND Group ID			
Default Value	Set by CFG Pin-strap Setting															
Format	Bit Field															
Bit Position	15	14	13	12	11	10	9	8	7	6	5	4	3	2	1	0
Access	R/W	R/W	R/W	R/W	R/W	R/W	R/W	R/W	R/W	R/W	R/W	R/W	R/W	R/W	R/W	R/W
Function	Not Used		EN>	OPERATION Group ID					Not Used		EN>	Power Fail Group ID				
Default Value	Set by CFG Pin-strap Setting															

**DDC\_GROUP (E2h)**

BITS	PURPOSE	VALUE	DESCRIPTION
31:22	Not Used	00	Not used
21	BROADCAST_VOUT_COMMAND response	1	Responds to broadcast VOUT_COMMAND with same Group ID
		0	Ignores broadcast VOUT_COMMAND
20:16	BROADCAST_VOUT_COMMAND group ID	0-31d	Group ID sent as data for broadcast VOUT_COMMAND events
15:14	Not Used	00	Not used
13	BROADCAST_OPERATION response	1	Responds to broadcast OPERATION with same Group ID
		0	Ignores broadcast OPERATION
12:8	BROADCAST_OPERATION group ID	0-31d	Group ID sent as data for broadcast OPERATION events
7:6	Not Used	00	Not used



Asia-Pacific +86 755 298 85888 Europe, Middle East +353 61 225 977 North America +1 408 785 5200

5	POWER_FAIL response	1	Responds to POWER_FAIL events with same Group ID by shutting down immediately
		0	Responds to POWER_FAIL events with same Group ID with sequenced shutdown
4:0	POWER_FAIL group ID	0-31d	Group ID sent as data for broadcast POWER_FAIL events

**DEVICE\_ID (E4h)**

Definition: Returns the 16-byte (character) device identifier string. The format is: Part number, Major Revision, (period), Minor Revision, Engineering version letter

Paged or Global: Global

Data Length in Bytes: 16

Data Format: ASCII. ISO/IEC 8859-1

Type: Block Read

Protectable: Read Only

Default Value: ZL8802, current major revision, (period), current minor revision, current engineering version letter

Units: N/A

COMMAND	DEVICE_ID (E4h)															
Format	Characters (Bytes)															
Characters	15	14	13	12	11	10	9	8	7	6	5	4	3	2	1	0
Access	R	R	R	R	R	R	R	R	R	R	R	R	R	R	R	R
Function	Part Number										Maj. Rev.		.	Min. Rev		Engr.
Default Value	Z	L	8	8	0	0					*	*	*	*	*	*
* Current revision at time of manufacture																

**MFR\_IOUT\_OC\_FAULT\_RESPONSE (E5h)**

Definition: Configures the IOUT overcurrent fault response as defined by the table below. The command format is the same as the Power Management bus standard fault responses except that it sets the overcurrent status bit in STATUS\_IOUT. The retry time is the time between restart attempts.

Paged or Global: Paged

Data Length in Bytes: 1

Data Format: Bit Field

Type: R/W

Protectable: Yes

Default Value: 80h (immediate shutdown, no retries)

Units: Retry time

unit = 35ms

COMMAND	MFR_IOUT_OC_FAULT_RESPONSE (E5h)
Format	Bit Field



Bit Position	7	6	5	4	3	2	1	0
Access	R/W	R/W	R/W	R/W	R/W	R/W	R/W	R/W
Function	See Following Table							
Default Value	1	0	0	0	0	0	0	0



Asia-Pacific  
+86 755 298 85888

Europe, Middle East  
+353 61 225 977

North America  
+1 408 785 5200

**MFR\_IOUT\_OC\_FAULT\_RESPONSE (E5h)**

BIT	FIELD NAME	VALUE	DESCRIPTION
7:6	Response behavior, for all modes, the device: • Pulls SALRT low • Sets the related fault bit in the status registers. Fault bits are only cleared by the CLEAR_FAULTS command.	00	Not used
		01	Not used
		10	Disable without delay and retry according to the setting in bits 5:3.
		11	Output is disabled while the fault is present. Operation resumes and the output is enabled when the fault is no longer present.
5:3	Retry Setting	000	No retry. The output remains disabled until the fault is cleared.
		001-110	Not used
		111	Attempts to restart continuously, without checking if the fault is still present, until it is commanded OFF (by the CONTROL pin or OPERATION command or both), bias power is removed, or another fault condition causes the unit to shut down. The time between the start of each attempt to restart is set by the value in bits [2:0] multiplied by 35ms.
2:0	Retry Delay	000-111	Retry delay time = (Value +1)*35ms. Sets the time between retries in 35ms increments. Range is 35ms to 280ms.

**MFR\_IOUT\_UC\_FAULT\_RESPONSE (E6h)**

Definition: Configures the IOUT undercurrent fault response as defined by the table below. The command format is the same as the Power Management bus standard fault responses except that it sets the undercurrent status bit in STATUS\_IOUT. The retry time is the time between

restart attempts.

Data Length in Bytes: 1

Paged or Global: Paged

Data Format: Bit Field

Type: R/W

Protectable: Yes

Default Value: 80h (Immediate shutdown, no retries)

Units: Retry time

unit = 35ms

COMMAND	MFR_IOUT_UC_FAULT_RESPONSE (E6h)							
Format	Bit Field							
Bit Position	7	6	5	4	3	2	1	0
Access	R/W	R/W	R/W	R/W	R/W	R/W	R/W	R/W
Function	See Following Table							
Default Value	1	0	0	0	0	0	0	0

BIT	FIELD NAME	VALUE	DESCRIPTION
7:6	Response behavior, for all modes, the device: • Pulls SALRT low • Sets the related fault bit in the status registers. Fault bits are only cleared by the CLEAR_FAULTS command.	00	Not used
		01	Not used
		10	Disable without delay and retry according to the setting in bits 5:3.
		11	Output is disabled while the fault is present. Operation resumes and the output is enabled when the fault is no longer present.
5:3	Retry Setting	000	No retry. The output remains disabled until the fault is cleared.
		001-110	Not used
		111	Attempts to restart continuously, without checking if the fault is still present, until it is commanded OFF (by the CONTROL pin or OPERATION command or both), bias power is removed, or another fault condition causes the unit to shut down. The time between the start of each attempt to restart is set by the value in bits [2:0] multiplied by 35ms.
2:0	Retry Delay	000-111	Retry delay time = (Value + 1)*35ms. Sets the time between retries in 35ms increments. Range is 35ms to 280ms.

**IOUT\_AVG\_OC\_FAULT\_LIMIT (E7h)**

Definition: Sets the IOU average overcurrent fault threshold. For down-slope sensing, this corresponds to the average of all the current samples taken during the (1-D) time interval, excluding the current sense blanking time (which occurs at the beginning of the 1-D interval). For up-slope sensing, this corresponds to the average of all the current samples taken during the D time interval, excluding the current sense blanking time (which occurs at the beginning of the D interval). This feature shares the OC fault bit operation (in STATUS\_IOU) and OC fault response with IOU\_OC\_FAULT\_LIMIT.

Paged or Global: Paged

Data Length in Bytes: 2

Data Format: Linear-11

Type: R/W

Protectable: Yes

Default Value: CFG pin-strap setting

Units: Amperes

Equation:  $IOU\_AVG\_OC\_FAULT\_LIMIT = Y \times 2^N$

Range: -100A to 100A

COMMAND	IOU_AVG_OC_FAULT_LIMIT (E7h)															
Format	Linear-11															
Bit Position	15	14	13	12	11	10	9	8	7	6	5	4	3	2	1	0
Access	R/W	R/W	R/W	R/W	R/W	R/W	R/W	R/W	R/W	R/W	R/W	R/W	R/W	R/W	R/W	R/W
Function	Signed Exponent, N								Signed Mantissa, Y							
Default Value	CFG Pin-strap Setting															



Asia-Pacific  
+86 755 298 85888

Europe, Middle East  
+353 61 225 977

North America  
+1 408 785 5200

**IOUT\_AVG\_UC\_FAULT\_LIMIT (E8h)**

Definition: Sets the IOUT average undercurrent fault threshold. For down-slope sensing, this corresponds to the average of all the current samples taken during the (1-D) time interval, excluding the current sense blanking time (which occurs at the beginning of the 1-D interval). For up-slope sensing, this corresponds to the average of all the current samples taken during the D time interval, excluding the current sense blanking time (which occurs at the beginning of the D interval). This feature shares the UC fault bit operation (in STATUS\_IOUT) and UC fault response with IOUT\_UC\_FAULT\_LIMIT.

Paged or Global: Paged

Data Length in Bytes: 2

Data Format: Linear-11

Type: R/W

Protectable: Yes

Default Value: -1 X IOUT\_AVG\_OC\_FAULT\_LIMIT as set by CFG pin-strap setting

Units: Amperes

Equation:  $IOUT\_AVG\_UC\_FAULT\_LIMIT = Y \times 2^N$

Range: -100A to 100A

COMMAND	IOUT_AVG_UC_FAULT_LIMIT (E8h)															
Format	Linear-11															
Bit Position	15	14	13	12	11	10	9	8	7	6	5	4	3	2	1	0
Access	R/W	R/W	R/W	R/W	R/W	R/W	R/W	R/W	R/W	R/W	R/W	R/W	R/W	R/W	R/W	R/W
Function	Signed Exponent, N								Signed Mantissa, Y							
Default Value	-1 X IOUT_AVG_OC_FAULT_LIMIT as set by CFG Pin-strap Setting															

**USER\_GLOBAL\_CONFIG (E9h)**

Definition: This command is used to set options for output voltage sensing, VMON/TMON pin configuration, SMBus time-out and DDC and SYNC output configurations.

Paged or Global: Global

Data Length in Bytes: 2

Data Format: Bit Field

Type: R/W

Protectable: Yes

Default Value: Set by CFG pin-strap setting

Units: N/A

COMMAND	USER_GLOBAL_CONFIG (E9h)															
Format	Bit Field															
Bit Position	15	14	13	12	11	10	9	8	7	6	5	4	3	2	1	0
Access	R/W	R/W	R/W	R/W	R/W	R/W	R/W	R/W	R/W	R/W	R/W	R/W	R/W	R/W	R/W	R/W
Function	See Following Table															
Default Value	Set by CFG Pin-strap Setting															

**USER\_GLOBAL\_CONFIG (E9h)**

BITS	PURPOSE	VALUE	DESCRIPTION
15:13	Not Used	000000	Not used
12	VMON/TMON Config	0	MFR_READ_VMON returns voltage on VMON pin in Volts. External 16:1 voltage divider needed on VMON/TMON pin (pin 6) to voltage being monitored.
		1	READ_TEMPERATURE_3 returns TMON in °C. External 2:1 voltage divider needed on VMON/TMON pin (pin 6) to SPS TMON pin.
11:10	Not Used	00	Not used
9:8	SENSE Select for monitoring and fault detection	00	Output 0 uses VSEN0, Output 1 uses VSEN1
		01	Both outputs use VSEN0
		10-11	Not used
7	Not Used	0	Not used
6	DDC output Configuration	0	DDC output open drain
		1	DDC output push-pull
5	Not Used	0	Not used
4	Disable SMBus Time-Outs	0	SMBus time-outs enabled
		1	SMBus time-outs disabled
3	Not Used	0	Not used
2:1	Sync I/O Control	00	Use internal clock (frequency initially set with pin-strap)
		01	Use internal clock and output internal clock (not for use with pin-strap)
		10	Use external clock
		11	Not used
0	Not Used	0	Not used

**SNAPSHOT (EAh)**

Definition: The SNAPSHOT command is a 32-byte read-back of parametric and status values. It allows monitoring and status data to be stored to flash either during a fault condition or via a system-defined time using the SNAPSHOT\_CONTROL command. Snapshot is continuously updated in RAM and can be read using the SNAPSHOT command. When a fault occurs, the latest snapshot in RAM is stored to flash. Snapshot data can read back by writing a 01h to the SNAPSHOT\_CONTROL command, then reading SNAPSHOT.

Paged or Global: Paged

Data Length in Bytes: 32

Data Format: Bit Field

Type: Block Read

Protectable: No

Default Value: N/A

Units: N/A



Asia-Pacific  
+86 755 298 85888

Europe, Middle East  
+353 61 225 977

North America  
+1 408 785 5200

BYTE NUMBER	VALUE	Power Management bus COMMAND	FORMAT
31:23	Not Used	Not Used	0000h
22	Flash Memory Status Byte	N/A	Bit Field
21	Manufacturer Specific Status Byte	STATUS_MFR_SPECIFIC (80h)	1 Byte Bit Field
20	CML Status Byte	STATUS_CML (7Eh)	1 Byte Bit Field
19	Temperature Status Byte	STATUS_TEMPERATURE (7Dh)	1 Byte Bit Field
18	Input Status Byte	STATUS_INPUT (7Ch)	1 Byte Bit Field
17	IOUT Status Byte	STATUS_IOUT (7Bh)	1 Byte Bit Field
16	VOUT Status Byte	STATUS_VOUT (7Ah)	1 Byte Bit Field
15:14	Switching Frequency	READ_FREQUENCY (95h)	2 Byte Linear-11
13:12	External Temperature	READ_TEMPERATURE_2 (8Eh)	2 Byte Linear-11
11:10	Internal Temperature	READ_TEMPERATURE_1 (8Dh)	2 Byte Linear-11
9:8	Duty Cycle	READ_DUTY_CYCLE (94h)	2 Byte Linear-11
7:6	Highest Measured Output Current	N/A	2 Byte Linear-11
5:4	Output Current	READ_IOUT (8Ch)	2 Byte Linear-11
3:2	Output Voltage	READ_VOUT (8Bh)	2 Byte Linear-16 Unsigned
1:0	Input Voltage	READ_VIN (88h)	2 Byte Linear-11

#### LEGACY\_FAULT\_GROUP (F0h)

**Definition:** This command allows the ZL8802 to sequence and fault spread with devices other than the ZL8800 family of ICs. This command sets which rail DDC IDs should be listened to for fault spreading information. The data sent is a 4-byte, 32-bit bit vector where every bit represents a rail's DDC ID. A bit set to 1 indicates a device DDC ID to which the configured device will respond upon receiving a fault spreading event. In this vector, bit 0 of byte 0 corresponds to the rail with DDC ID 0. Following through, Bit 7 of byte 3 corresponds to the rail with DDC ID 31.

**NOTE:** The device/rail's own DDC ID should not be set within the LEGACY\_FAULT\_GROUP command for that device/rail.

All devices in a current share rail (devices other than the ZL8800 family ICs) must shut down for the rail to report a shutdown.

If fault spread mode is enabled in USER\_CONFIG, the device will immediately shut down if one of its DDC\_GROUP members fail. The device/rail will attempt its configured restart only after all devices/rails within the DDC\_GROUP have cleared their faults.

If fault spread mode is disabled in USER\_CONFIG, the device will perform a sequenced shutdown as defined by the SEQUENCE command setting. The rails/devices in a sequencing set only attempt their configured restart after all faults have cleared within the DDC\_GROUP. If fault spread mode is disabled and sequencing is also disabled, the device will ignore faults from other devices and stay enabled.

Paged or Global: Paged

Data Length in Bytes: 4

Data Format: Bit field

Type: Block R/W

Protectable: Yes

Default Value: 00000000h

Units: N/A

COMMAND	LEGACY_FAULT_GROUP (F0h)															
Format	Bit Field															
Bit Position	31	30	29	28	27	26	25	24	23	22	21	20	19	18	17	16
Access	R/W	R/W	R/W	R/W	R/W	R/W	R/W	R/W	R/W	R/W	R/W	R/W	R/W	R/W	R/W	R/W
Function	See Following Table															
Default Value	0	0	0	0	0	0	0	0	0	0	0	0	0	0	0	0
Format	Bit Field															
Bit Position	15	14	13	12	11	10	9	8	7	6	5	4	3	2	1	0
Access	R/W	R/W	R/W	R/W	R/W	R/W	R/W	R/W	R/W	R/W	R/W	R/W	R/W	R/W	R/W	R/W
Function	See Following Table															
Default Value	0	0	0	0	0	0	0	0	0	0	0	0	0	0	0	0

BIT	FIELD NAME	VALUE	SETTING	DESCRIPTION
31:0	Fault Group	NA	00000000h	Identifies the devices in the fault spreading group.

**SNAPSHOT\_CONTROL (F3h)**

Definition: Writing a 01h will cause the device to copy the current SNAPSHOT values from NVRAM to the 32-byte SNAPSHOT command parameter. Writing a 02h will cause the device to write the current SNAPSHOT values to NVRAM, 03h will erase all SNAPSHOT values from NVRAM. Write (02h) and Erase (03h) may only be used when the device is disabled. All other values will be ignored. SNAPSHOT 03h must be written to the device when the device is DISABLED. Data will not be updated, or written to NVRAM after a fault occurs until the SNAPSHOT 03h command has been written.

Paged or Global: Paged

Data Length in Bytes: 1

Data Format: Bit Field

Type: R/W Byte

Protectable: Yes

Default Value: 00h

Units: N/A

COMMAND	SNAPSHOT_CONTROL (F3h)							
Format	Bit Field							
Bit Position	7	6	5	4	3	2	1	0
Access	R/W	R/W	R/W	R/W	R/W	R/W	R/W	R/W
Function	See Following Table							
Default Value	0	0	0	0	0	0	0	0

VALUE	DESCRIPTION
01	Read SNAPSHOT values from NVRAM
02	Write SNAPSHOT values to NVRAM
03	Erase SNAPSHOT values from NVRAM



Asia-Pacific  
+86 755 298 85888

Europe, Middle East  
+353 61 225 977

North America  
+1 408 785 5200





### RESTORE\_FACTORY (F4h)

Definition: Restores the device to the hard-coded factory default values and pin-strap definitions. The device retains the DEFAULT and USER stores for restoring. Security level is changed to Level 1 following this command.

Paged or Global: Global

Data Length in Bytes: 0

Data Format: N/A

Type: Write Only

Protectable: Yes

Default Value: N/A

Units: N/A

### MFR\_VMON\_OV\_FAULT\_LIMIT (F5h)

Definition: Sets the VMON over-temperature fault threshold. The VMON overvoltage warn limit is automatically set to 90% of this fault value. If VMON is not used, set VMON\_OV\_FAULT\_RESPONSE to 00h, which will disable VMON OV faults entirely.

Paged or Global: Global

Data Length in Bytes: 2

Data Format: Linear-11

Type: R/W

Protectable: Yes

Default Value: C266h (2.4V)

Units: Volts

Equation:  $MFR\_VMON\_OV\_FAULT\_LIMIT = Y \times 2^N$

Range: 0 to 20V

COMMAND	MFR_VMON_OV_FAULT_LIMIT (F5h)															
Format	Linear-11															
Bit Position	15	14	13	12	11	10	9	8	7	6	5	4	3	2	1	0
Access	R/W	R/W	R/W	R/W	R/W	R/W	R/W	R/W	R/W	R/W	R/W	R/W	R/W	R/W	R/W	R/W
Function	Signed Exponent, N					Signed Mantissa, Y										
Default Value	1	1	1	0	0	0	1	0	0	1	1	0	0	1	1	0

### MFR\_VMON\_UV\_FAULT\_LIMIT (F6h)

Definition: Sets the VMON undervoltage fault threshold. The VMON undervoltage warn limit is automatically set to 110% of this fault value. If VMON is not used, set VMON\_UV\_FAULT\_RESPONSE to 00h, which will disable VMON UV faults entirely.

Paged or Global: Global

Data Length in Bytes: 2

Data Format: Linear-11

Type: R/W

Protectable: Yes

Default Value: B0CCh (0.2V)

Units: Volts

Equation:  $MFR\_VMON\_UV\_FAULT\_LIMIT = Y \times 2^N$

Range: 0 to 20V



Asia-Pacific  
+86 755 298 85888

Europe, Middle East  
+353 61 225 977

North America  
+1 408 785 5200

COMMAND	MFR_VMON_UV_FAULT_LIMIT (F6h)															
Format	Linear-11															
Bit Position	15	14	13	12	11	10	9	8	7	6	5	4	3	2	1	0
Access	R/W	R/W	R/W	R/W	R/W	R/W	R/W	R/W	R/W	R/W	R/W	R/W	R/W	R/W	R/W	R/W
Function	Signed Exponent, N					Signed Mantissa, Y										
Default Value	1	0	1	1	0	0	0	0	1	1	0	0	1	1	0	0

**MFR\_READ\_VMON (F7h)**

Definition: Reads the voltage on the VMON pin.

Paged or Global: Global

Data Length in Bytes: 2

Data Format: Linear-11

Type: Read Only

Protectable: No

Default Value: N/A

Units: °C

Equation:  $MFR\_READ\_VMON = Y \times 2^N$

Range: -200°C to +200°C

COMMAND	MFR_READ_VMON (F7h)															
Format	Linear-11															
Bit Position	15	14	13	12	11	10	9	8	7	6	5	4	3	2	1	0
Access	R/W	R/W	R/W	R/W	R/W	R/W	R/W	R/W	R/W	R/W	R/W	R/W	R/W	R/W	R/W	R/W
Function	Signed Exponent, N					Signed Mantissa, Y										
Default Value	N/A	N/A	N/A	N/A	N/A	N/A	N/A	N/A	N/A	N/A	N/A	N/A	N/A	N/A	N/A	N/A

**VMON\_OV\_FAULT\_RESPONSE (F8h)**

Definition: Configures the VMON overvoltage fault response as defined by the table below. Note: The retry time is the time between restart attempts. If VMON is not used, set this response to 00h, which will disable VMON OV faults entirely

Paged or Global: Global

Data Length in Bytes: 1

Data Format: Bit Field

Type: R/W

Protectable: Yes

Default Value: BFh (continuous retries)

Units: N/A

COMMAND	VMON_OV_FAULT_RESPONSE (F8h)							
Format	Bit Field							
Bit Position	7	6	5	4	3	2	1	0
Access	R/W	R/W	R/W	R/W	R/W	R/W	R/W	R/W
Function	See Following Table							
Default Value	1	0	1	1	1	1	1	1

BIT	FIELD NAME	VALUE	DESCRIPTION
7:6	Response behavior, the device: • Pulls SALRT low • Sets the related fault bit in the status registers. Fault bits are only cleared by the CLEAR_FAULTS command.	00	Ignore faults
		01	Not used
		10	Disable without delay and retry according to the setting in bits 5:3.
		11	Output is disabled while the fault is present. Operation resumes and the output is enabled when VMON falls below 95% of the VMON_OV_FAULT_LIMIT setting.
5:3	Retry Setting	000	No retry. The output remains disabled until the fault is cleared.
		001-110	Not used
		111	Attempts to restart continuously, without checking if the fault is still present, until it is commanded OFF (by the CONTROL pin or OPERATION command or both), bias power is removed, or another fault condition causes the unit to shut down. A retry is attempted after VMON falls below 95% of the VMON_OV_FAULT_LIMIT. The time between the start of each attempt to restart is set by the value in bits [2:0] multiplied by 35ms.
2:0	Retry Delay	000-111	Retry delay time = (Value +1)*35ms. Sets the time between retries in 35ms increments. Range is 35ms to 280ms.

#### VMON\_UV\_FAULT\_RESPONSE (F9h)

Definition: Configures the VMON undervoltage fault response as defined by the table below. Note: The retry time is the time between restart attempts. If VMON is not used, set this response to 00h, which will disable VMON UV faults entirely

Paged or Global: Global

Data Length in Bytes: 1

Data Format: Bit Field.

Type: R/W

Protectable: Yes

Default Value: BFh (continuous retries)

Units: Retry time

unit = 35ms

COMMAND	VMON_UV_FAULT_RESPONSE (F9h)							
Format	Bit Field							
Bit Position	7	6	5	4	3	2	1	0
Access	R/W	R/W	R/W	R/W	R/W	R/W	R/W	R/W
Function	See Following Table							
Default Value	1	0	1	1	1	1	1	1

BIT	FIELD NAME	VALUE	DESCRIPTION
7:6	Response behavior, the device: • Pulls SALRT low • Sets the related fault bit in the status registers. Fault bits are only cleared by the CLEAR_FAULTS command.	00	Fault ignored
		01	Not used
		10	Disable without delay and retry according to the setting in bits 5:3.
		11	Output is disabled while the fault is present. Operation resumes and the output is enabled when VMON rises above 105% of the VMON_UV_FAULT_LIMIT setting.
5:3	Retry Setting	000	No retry. The output remains disabled until the fault is cleared.
		001-110	Not used
		111	Attempts to restart continuously, without checking if the fault is still present, until it is commanded OFF (by the CONTROL pin or OPERATION command or both), bias power is removed, or another fault condition causes the unit to shut down. A retry is attempted after VMON has risen above 105% of VMON_UV_FAULT_LIMIT. The time between the start of each attempt to restart is set by the value in bits [2:0] multiplied by 35ms.
2:0	Retry Delay	000-111	Retry delay time = (Value + 1)*35ms. Sets the time between retries in 35ms increments. Range is 35ms to 280ms.

### SECURITY\_LEVEL (FAh)

Definition: The device provides write protection for individual commands. Each bit in the UNPROTECT parameter controls whether its corresponding command is writeable (commands are always readable). If a command is not writeable, a password must be entered in order to change its parameter (i.e., to enable writes to that command). There are two types of passwords, public and private. The public password provides a simple lock-and-key protection against accidental changes to the device. It would typically be sent to the device in the application prior to making changes. Private passwords allow commands marked as nonwritable in the UNPROTECT parameter to be changed. Private passwords are intended for protecting default-installed configurations and would not typically be used in the application. Each store (USER and DEFAULT) can have its own UNPROTECT string and private password. If a command is marked as nonwritable in the DEFAULT UNPROTECT parameter (its corresponding bit is cleared), the private password in the DEFAULT store must be sent in order to change that command. If a command is writeable according to the default UNPROTECT parameter, it may still be marked as nonwritable in the user store UNPROTECT parameter. In this case, the user private password can be sent to make the command writeable.

The device supports four levels of security. Each level is designed to be used by a particular class of users, ranging from module manufacturers to end users, as discussed below. Levels 0 and 1 correspond to the public password. All other levels require a private password. Writing a private password can only raise the security level. Writing a public password will reset the level down to 0 or 1.

[Figure on next page](#) shows the algorithm used by the device to determine if a particular command write is allowed.

Paged or Global: Global

Data Length in Bytes: 1

Data Format: Hex

Type: Read Byte

Protectable: No

Default Value: 01h

Units: N/A

SECURITY\_LEVEL (FAh)

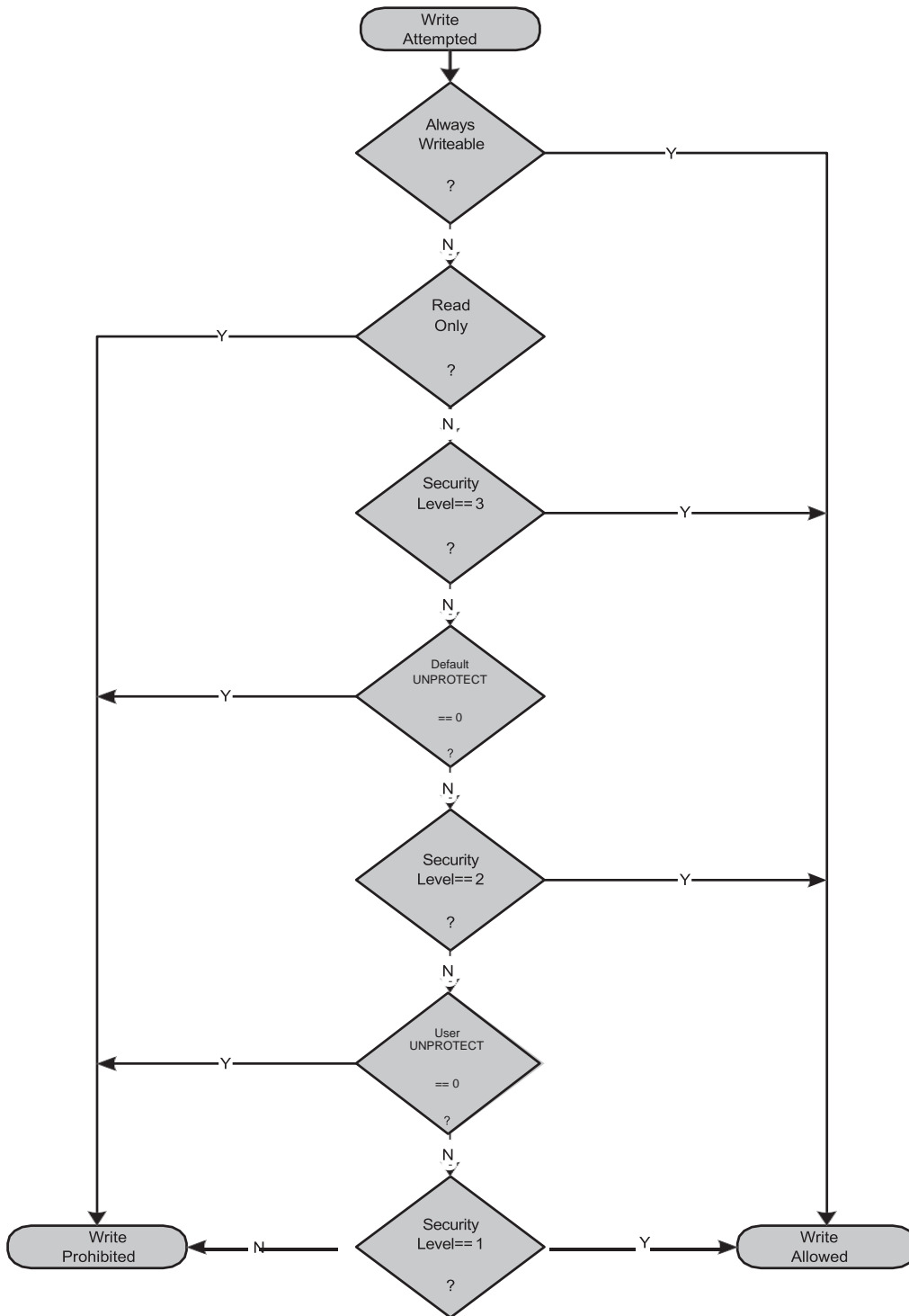

Figure 55. ALGORITHM USED TO DETERMINE WHEN A COMMAND IS WRITEABLE

**Security Level 3 – Module Vendor**

Level 3 is intended primarily for use by module vendors to protect device configurations in the default store. Clearing a UNPROTECT bit in the default store implies that a command is writeable only at Level 3 and above. The device's security level is raised to Level 3 by writing the private password value previously stored in the default store. To be effective, the module vendor must clear the UNPROTECT bit corresponding to the STORE\_DEFAULT\_ALL and RESTORE\_DEFAULT commands. Otherwise, Level 3 protection is ineffective since the entire store could be replaced by the user, including the enclosed private password.

**Security Level 2 – User**

Level 2 is intended for use by the end user of the device. Clearing a UNPROTECT bit in the user store implies that a command is writeable only at Level 2 and above. The device's security level is raised to Level 2 by writing the private password value previously stored in the User Store. To be effective, the user must clear the UNPROTECT bit corresponding to the STORE\_USER\_ALL, RESTORE\_DEFAULT\_ALL, STORE\_DEFAULT\_ALL and RESTORE\_DEFAULT commands. Otherwise, Level 2 protection is ineffective since the entire store could be replaced, including the enclosed private password.

**Security Level 1 – Public**

Level 1 is intended to protect against accidental changes to ordinary commands by providing a global write-enable. It can be used to protect the device from erroneous bus operations. It provides access to commands whose UNPROTECT bit is set in both the default and User Store. Security is raised to Level 1 by writing the public password stored in the user store using the PUBLIC\_PASSWORD command. The public password stored in the default store has no effect.

**Security Level 0 - Unprotected**

Level 0 implies that only commands which are always writeable (e.g., PUBLIC\_PASSWORD) are available. This represents the lowest authority level and hence the most protected state of the device. The level can be reduced to 0 by using PUBLIC\_PASSWORD to write any value which does not match the stored public password.

**PRIVATE\_PASSWORD (FBh)**

Definition: Sets the private password string.

Paged or Global: Global

Data Length in Bytes: 9

Data Format: ASCII. ISO/IEC 8859-1

Type: Block R/W

Protectable: No

Default Value: 000000000000000000h

Units: N/A

**PUBLIC\_PASSWORD (FCh)**

Definition: Sets the public password string.

Paged or Global: Global

Data Length in Bytes: 4

Data Format: ASCII. ISO/IEC 8859-1

Type: Block R/W

Protectable: No

Default Value: 00000000h

Units: N/A

**UNPROTECT (FDh)**

Definition: Sets a 256-bit (32-byte) parameter which identifies which commands are to be protected against write-access at lower security levels. Each bit in this parameter corresponds to a command according to the command's code. The command with a code of 00h (PAGE) is protected by the least-significant bit of the least-significant byte, followed by the command with a code of 01h and so forth. Note that all possible commands have a corresponding bit regardless of whether they are protectable or supported by the device. Clearing a command's UNPROTECT bit indicates that write-access to that command is only allowed if the device's security level has been raised to an appropriate level. The UNPROTECT bits in the default store require a security level 3 or greater to be writeable. The UNPROTECT bits in the user store require a security level of 2 or higher.

Data Length in Bytes: 32

Paged or Global: Global

Data Format: Custom

Type: Block R/W

Protectable: No

Default Value: FF...FFh

Units: N/A

## 28. SOLDERING INFORMATION

The SRBP-80A2P0 modules are designed to be compatible with reflow soldering process. The suggested Pb-free solder paste is Sn/Ag/Cu(SAC). The recommended reflow profile using Sn/Ag/Cu solder is shown in the following. Recommended reflow peak temperature is 245 °C. This profile should be used only as a guideline. Many other factors influence the success of SMT reflow soldering. Since your production environment may differ, please thoroughly review these guidelines with your process engineers.

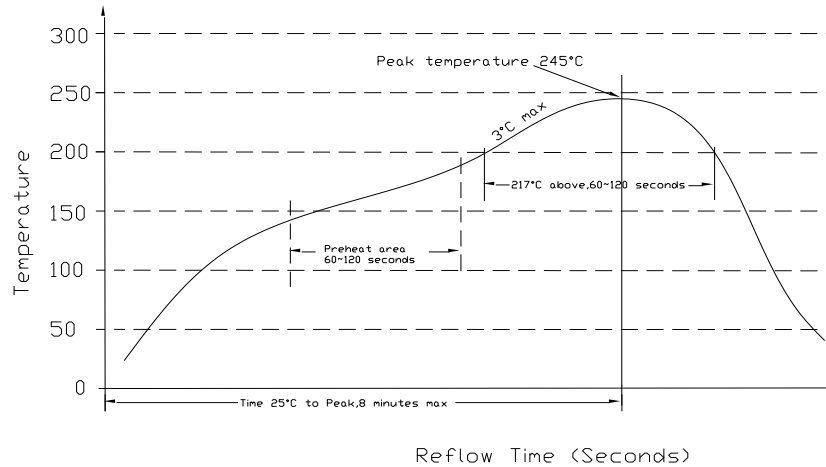

Figure 56.

## 29. MSL RATING

The SRBP-80A2P0 modules have a MSL rating of 3.

## 30. STORAGE AND HANDLING

The SRBP-80A2P0 modules are designed to be compatible with J-STD-033 Rev: A (Handling, Packing, Shipping and Use of Moisture /Reflow Sensitive surface Mount devices). Moisture barrier bags (MBB) with desiccant are applied. The recommended storage environment and handling procedure is detailed in J-STD-033.

## 31. PRE-BAKING

This component has been designed, handled, and packaged ready for Pb-free reflow soldering. If the assembly shop follows J-STD-033 guidelines, no pre-bake of this component is required before being reflowed to a PCB. However, if the J-STD-033 guidelines are not followed by the assembler, Bel recommends that the modules should be pre-baked @ 120~125°C for a minimum of 4 hours (preferably 24 hours) before reflow soldering. Our packaging tray can only withstand temperature of 70°C max.



**32. MECHANICAL DIMENSIONS**  
**OUTLINE**

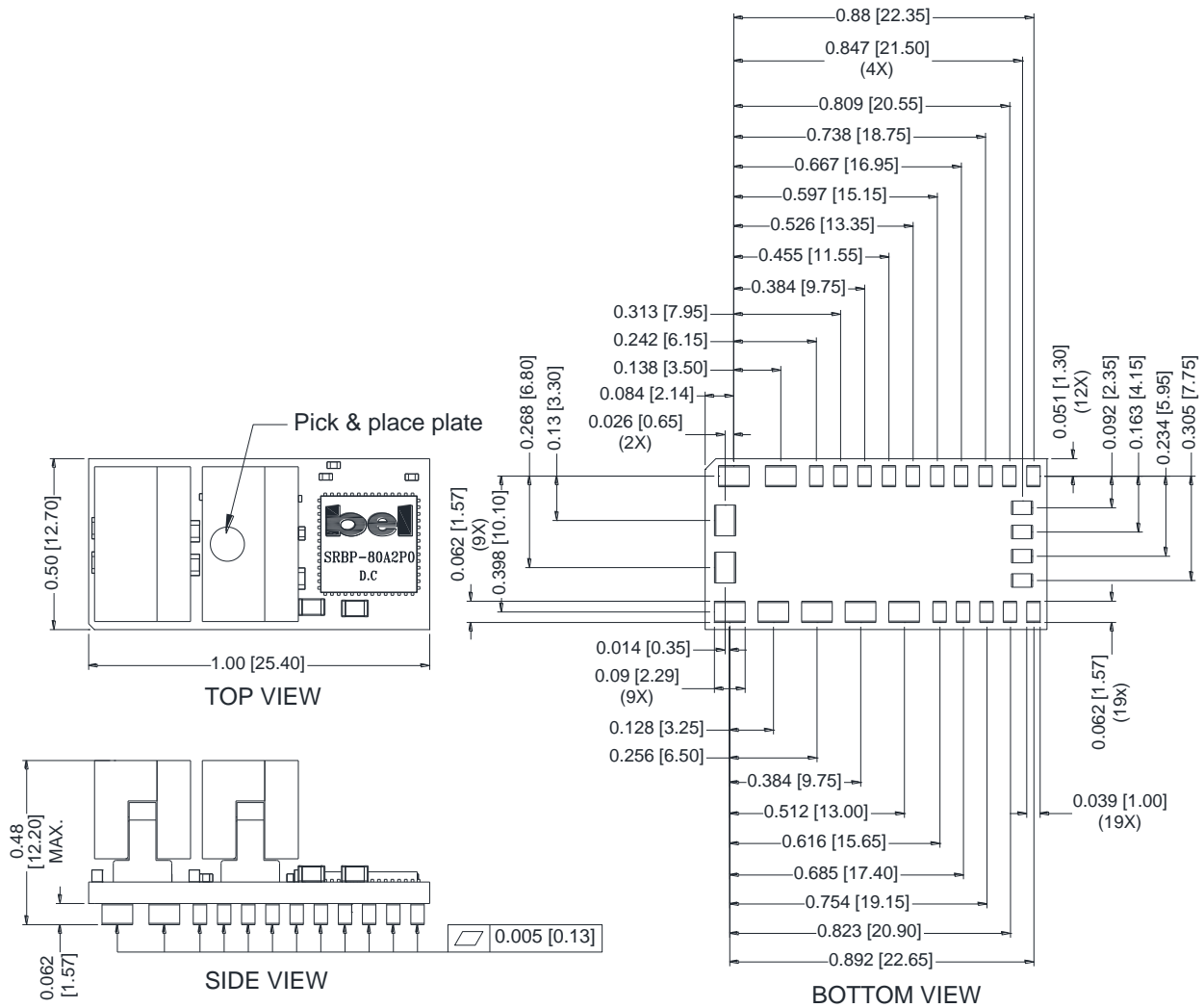

Figure 57. Outline

**NOTES:**

- 1) All Pins: Material - Copper Alloy;  
Finish – Matte Tin
- 2) Un-dimensioned components are shown for visual reference only.
- 3) All dimensions in inches (mm); Tolerances: x.xx +/-0.02 inch. (x.x +/-0.5 mm); x.xxx +/-0.010 inch. (x.xx +/-0.25 mm).

RECOMMENDED PAD LAYOUT

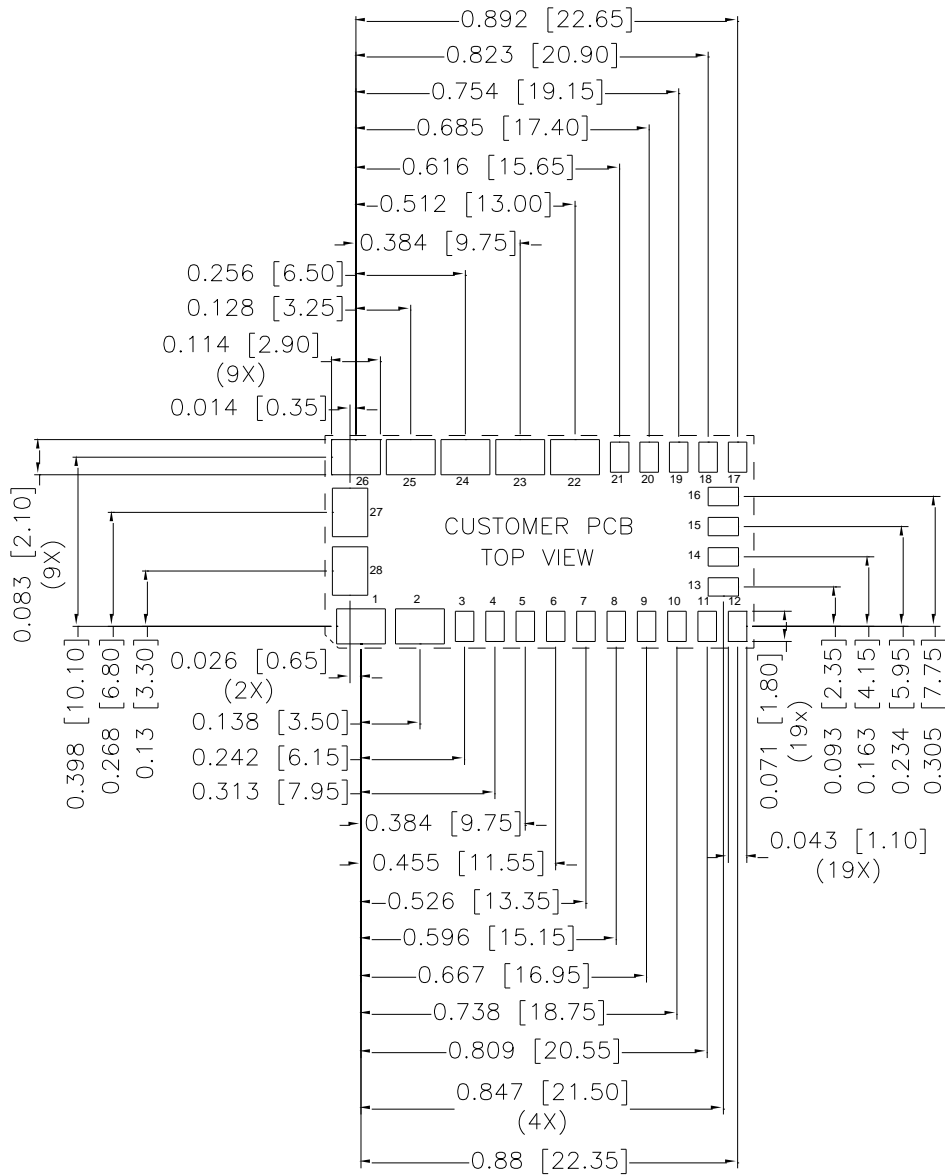
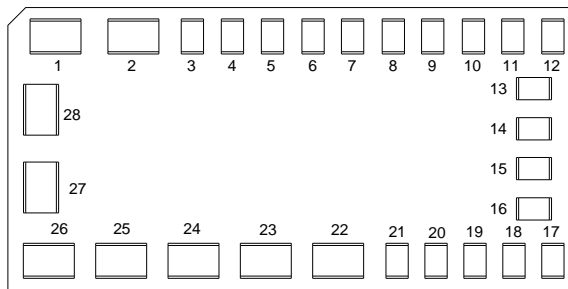

Figure 58. Recommended pad layout

## PIN CONNECTIONS



## BOTTOM VIEW

Figure 59. Pins

PIN	FUNCTION	PIN	FUNCTION
1	Vin	15	CFG
2	GND	16	Vtrim1
3	PG1	17	VS1+
4	PG2	18	VS1-
5	EN1	19	Vtrim2
6	EN2	20	VS2-
7	SYNC	21	VS2+
8	SHARE	22	Vout1
9	ADDR	23	Vout1
10	SCL	24	GND
11	SDA	25	Vout2
12	SALERT	26	Vout2
13	SGND	27	GND
14	ASCRCFG	28	Vin

**NOTE:**

- 1) Un-dimensioned components are shown for visual reference only.
- 2) All dimensions in inches (mm); Tolerances: x.xx +/-0.02 inch. (x.x +/-0.5 mm); x.xxx +/-0.010 inch. (x.xx +/-0.25 mm).

PIN	NAME	TYPE	FUNCTION
1	Vin	Power	Input voltage.
2	GND	Power	Power ground.
3	PG1	Out	Vo1 power-good output. Default is push-pull, can be set as an open-drain.
4	PG2	Out	Vo2 power-good output. Default is push-pull, can be set as an open-drain.
5	EN1	In	Enable or disable Vo1 of the module.
6	EN2	In	Enable or disable Vo2 of the module
7	SYNC	In/Out	Clock synchronization input. Set the switching frequency. Refer to Switching Frequency Setting.
8	SHARE	In/Out	Current sharing, communication bus between multiple modules.
9	ADDR	In	Serial address select pin. Connect resistor to SGND to assign unique address for each individual module.
10	SCL	In/Out	Serial clock. Requires a pull-up resistor to a 2.5V to 5.5V source, the source must be always on.
11	SDA	In/Out	Serial data. Requires a pull-up resistor to a 2.5V to 5.5V source, the source must be always on.
12	ALERT	Out	Serial alert. Asserted low when any fault or alarms are triggered. Requires a pull-up resistor to a 2.5V to 5.5V source, the source must be always on.
13	SGND	Power	Signal ground. SGND is shorted to GND internally.
14	ASCRCFG	In	Control loop configuration settings. Refer to control Loop(ASCR) Setting.
15	CFG	In	Setting current sense, current limit and operating mode. Refer to Configuration Setting.
16	Vtrim1	In	Setting output voltage Vo1. Connect resistor to SGND. Refer to Trim/Output Voltage Adjustment.
17	VS1+	In	Positive sense for Vo1. Connect to Vo1 close to the load.
18	VS1-	In	Negative sense fro Vo1. Connect to GND close to the load.
19	Vtrim2	In	Setting output voltage Vo2. Connect resistor to SGND. Refer to Trim/Output Voltage Adjustment.
20	VS2-	In	Negative sense fro Vo2. Connect to GND close to the load.
21	VS2+	In	Positive sense for Vo2. Connect to Vo2 close to the load.
22	Vo1	Power	Output Vo1.
23	Vo1	Power	Output Vo1.
24	GND	Power	Power ground.
25	Vo2	Power	Output Vo2.
26	Vo2	Power	Output Vo2.
27	GND	Power	Power ground.
28	Vin	Power	Input voltage.

### 34. REVISION HISTORY

DATE	REVISION	CHANGES DETAIL	APPROVAL
2017-07-14	AA	First release	Z.Tang
2017-11-08	AB	Update the MD, Startup & Shutdown, PG, TR, NR, TD and OCP.	Z.Tang
2018-03-26	AC	Update the Abs Max, Input Specs, Output Specs and Switching Frequency	Z.Tang
2018-04-23	AD	Update the MD, Model Selection, Output Specifications, General, OCP, OTP, Input under-voltage lockout and Power Good. Add Trim, ASCR, RCFG, SYNC, Package, SHARE and Power Management bus	Z.Tang
2019-06-03	AE	Delete OVP.	XF.Jiang
2019-08-06	AF	Update the Load Regulation in 4-phase, 6-phase 8-phase Mode. Delete package.	XF.Jiang
2021-03-17	AG	Add object ID, MTBF and input reflected ripple current waveform.	XF.Jiang

For more information on these products consult: [tech.support@psbel.com](mailto:tech.support@psbel.com)

**NUCLEAR AND MEDICAL APPLICATIONS** - Products are not designed or intended for use as critical components in life support systems, equipment used in hazardous environments, or nuclear control systems.

**TECHNICAL REVISIONS** - The appearance of products, including safety agency certifications pictured on labels, may change depending on the date manufactured. Specifications are subject to change without notice.



[tech.support@psbel.com](mailto:tech.support@psbel.com)  
[belfuse.com/power-solutions](http://belfuse.com/power-solutions)